



# Heating and cooling solutions from Alfa Laval

Everything you need for your industrial application







# Alfa Laval Industrial equipment mission statement

Alfa Laval's goal is to be the preferred partner for innovative and competitive solutions for cooling & heating components anywhere, at any time. We provide energy-saving solutions using compact heat exchangers as core technology. Together with our partners, we do this in manufacturing industries on all continents.

To help you find the right product for your industrial application we have developed this Product and Application Handbook. It is also available as an App for tablets, in digital format on [www.alfalaval.com/Machinery](http://www.alfalaval.com/Machinery) and on our eBusiness portal.

Whichever format you choose to learn more about our products – we have made sure it is as easy as possible for you to find the information you are looking for.

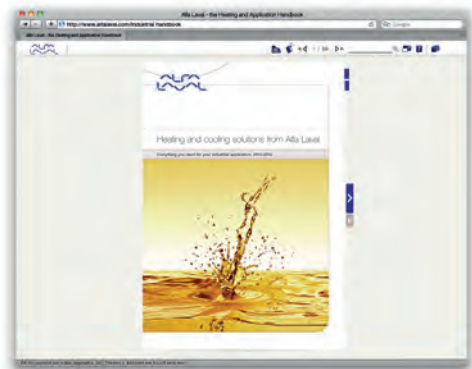





# Welcome to Alfa Laval

1. The Alfa Laval Group
2. Heating and cooling solutions from Alfa Laval
3. Applications
4. The theory behind heat transfer
5. Product range
6. Gasketed plate heat exchangers
7. Brazed plate heat exchangers
8. Fusion-bonded plate heat exchangers, AlfaNova
9. Air heat exchangers
10. All-welded heat exchangers
11. Filters



# Chapter 1

- 1. The Alfa Laval Group**
2. Heating and cooling solutions from Alfa Laval
3. Applications
4. The theory behind heat transfer
5. Product range
6. Gasketed plate heat exchangers
7. Brazed plate heat exchangers
8. Fusion-bonded plate heat exchangers, AlfaNova
9. Air heat exchangers
10. All-welded heat exchangers
11. Filters



# Our mission

We optimize the performance of our customers' processes.

Time and time again.



# Pure Performance

Alfa Laval focuses closely on offering its customers solutions that pay off.

This is clearly reflected in our mission:

To optimize the performance of our customers' processes. Time and time again.

This is a never-ending commitment. Every improvement we achieve creates a new platform for the next step on the improvement ladder.

Our aim is to stay in pole position at all times.





# High-tech performance

The Alfa Laval brand stands for technical expertise, reliable products, efficient service and the finest possible process-engineering skills.

Our reputation is based on our unique knowledge and experience in three key technologies:

- Separation
- Heat transfer
- Fluid handling

These are technologies that play major roles in most sectors of industry.



# Our company



## A global brand

Our equipment, systems and service are hard at work in more than 100 countries.

In 2011 Alfa Laval had 37 major production units and 99 service centres all over the world. The proximity to the market is vital to the company's success, for it is only by working closely with our customers that we can respond to their needs.



## 129 years young

The origin of the company dates back to 1883, when Gustaf de Laval founded Alfa Laval to exploit his pioneering invention of the centrifugal separator.

Gustav de Laval was a great technical genius who registered 92 patents in his lifetime. His innovative spirit has always been the guiding star for Alfa Laval and remains so to this day.



## 3.2 billion euros in sales

During 2011, Alfa Laval posted sales of 3.2 billion euros.

Europe is the biggest geographical market in terms of sales volume – roughly twice the size of both Asia and the American continent.



## 14,700 employees

Alfa Laval has nearly 14,700 highly qualified employees worldwide. Their basic mission is to assist industries of almost every kind to refine and improve their products and to optimise the performance of their processes. Thereby we help create better living conditions and a cleaner, safer environment for all mankind.



## Ten customer segments

To create a clear focus on different types of customer, Alfa Laval's business is divided into ten segments.

Each segment is dedicated to working closely with specific customer groups. This gives us insight into their special needs and the power to develop the best possible solutions to fulfil them.

## Technical leadership

Alfa Laval holds world-leading market positions in its fields of technical expertise.

Its success is based on an average investment of 2.5% of annual turnover in Research & Development.

The work of our almost 300 dedicated R&D specialists results in 35-40 new product releases every year.

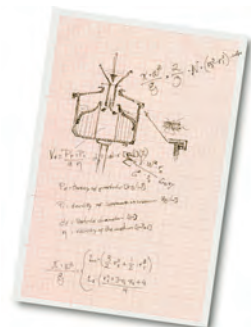



# Our key areas

## Separation

Alfa Laval has led the development of separation technology since the company was formed in 1883. Today Alfa Laval is the world's largest supplier of separation technologies.

## Heat transfer

Alfa Laval is the world leader in plate and spiral heat exchangers. It also offers the market's most extensive range of refrigeration equipment.

## Fluid handling

Alfa Laval produces flow equipment for industries requiring high standards of hygiene and reliable, continuous process flows.

## Heat transfer



**Plate heat exchangers**  
Alfa Laval has the most comprehensive range in the market for industrial, sanitary and heating applications.

**Air heat exchangers, evaporators and condensers**  
Designed for refrigeration.



## Shell-and-tube heat exchangers

An extensive range of heat exchangers dedicated to pharmaceutical, food and refrigeration applications.



## Spiral heat exchangers

Tailored for viscous and particulate products that can cause severe fouling or corrosion.



**Finned tube heat exchangers**  
Alfa Laval's range covers most types of refrigerants and most cooling applications.



## Separation



**High-speed separators**  
Primarily used for separating fluids and sludges containing up to 30% of solid particles.

## Membrane filtration

Alfa Laval's wide range of filters covers reverse osmosis, nanofiltration, ultra-filtration and microfiltration.



## Decanter centrifuges

For separating solids from liquids: a key function in countless industrial, food and treatment processes.



## Fluid handling



**Valves**  
Sanitary mixproof valves. Intelligent control equipment. For example: Butterfly valves. Seat valves. Aseptic diaphragm valves.

## Pumps

We cover every need for gentle, precision pumping of all kinds of fluids of all viscosities in sanitary applications.



## Tank equipment

We offer the widest range of sanitary applications for the marine/offshore business – supplying everything except the tank itself.



## Installation material

Our promise: You can always find the right installation material, in the right quantity, for the right application.



# Focus on customer segments



## Vegetable oils industry

Our equipment and systems produce tons of extra virgin olive oil every day.



## Marine industry

More than half of the world's ships are equipped with Alfa Laval products and solutions.



## Beverage industry

We manage the vital balance between flavour, food safety and manufacturing efficiency. Our equipment handles millions of litres of wine and beer every year.



## Wastewater

Alfa Laval has unique knowledge in the increasingly critical areas of effluent treatment and recycling.



## Energy

Alfa Laval is involved throughout the long process from the extraction of raw materials to the production and use of energy.



## The process industries

Alfa Laval's equipment and solutions are critical for performing and optimizing many industrial processes.



## Starch industry

More than half of the 60 million tons of starch produced in the world every year comes from our products and processes.



## Pharmaceutical and biotech industry

We offer a wide range of products to satisfy the industry's exceptional demands for precision, safety and cleanliness.



## Comfort/HVAC and refrigeration

Alfa Laval is a leader in climate control, providing an optimized balance of heating and cooling.



## Food industry

Our equipment helps the food industry to turn quality raw materials into equally high-quality products.





# Chapter 2

1. The Alfa Laval Group
- 2. Heating and cooling solutions from Alfa Laval**
3. Applications
4. The theory behind heat transfer
5. Product range
6. Gasketed plate heat exchangers
7. Brazed plate heat exchangers
8. Fusion-bonded plate heat exchangers, AlfaNova
9. Air heat exchangers
10. All-welded heat exchangers
11. Filters



# Heating and cooling solutions from Alfa Laval

The Alfa Laval Business Segment Industrial Equipment applies heat-transfer technology to heating and cooling systems, helping you to be more efficient in obtaining the ideal temperature for any service liquid.

Customers in more than 60 countries have made Alfa Laval the world market leader in heat exchangers and thermal solutions. Over 70 years of dedicated research and development in the field of heat-exchanger solutions, together with experience from millions of heating and cooling installations around the world, are your assurance that we have the solutions you are looking for.

There are many different ways to achieve reliable, economic temperature control. That's why a thorough understanding of each individual situation, the available resources and the real needs is the first step towards success.



# Global experience always near you

In a world of constant change, it can be comforting to know that some essentials will remain the same. One such essential is the local presence of Alfa Laval through our local sales companies and network of authorized distributors, who can meet all your needs and help you optimize your systems' performance.

Many of our customers are engaged in supplying state-of-the-art machinery and systems aimed for increasingly demanding customers within metal-working, electronics and hydraulics.

This calls for customized design to meet specifications that address local conditions and specific needs.

Others are expanding current plants or designing next generation systems within automotive or power conversion. This means analyzing the application benefits that new technology has to offer, locating opportunities for even faster return on investment, ensuring lower than ever total cost of ownership, and reducing environmental impact. Globalization is an obligation – the obligation to adapt global experience to meet local needs.

Alfa Laval is fully equipped to meet any project requirements from day one with fast answers and timely suggestions for improvements. These are the success factors that lead to a rewarding, long-term customer supplier relationship.

#### **Time is money: that's why it's easy to do business with us**

Speed and simplicity are essential for us, because a company's leadership derives not just from the quality of its products, but also from its organization and the services it offers. This is why we provide our customers with all the tools they need to do business with us easily and efficiently. Contact our local representative to learn more about the latest available tools.

#### **We know because we have been there**

Alfa Laval customers always benefit from our first-hand experience in hundreds of projects in different countries and environments all over the world. You can access our experience through our global team of Alfa Laval experts and partners. Your Alfa Laval agent is just a phone call away, while contact details for all countries are continually updated on our website at [www.alfalaval.com](http://www.alfalaval.com)

#### **Fast, timely delivery**

Experienced planning means superior logistics. At Alfa Laval, we believe that deliveries should not merely be in time. They should be just in time in order to save money and storage space for our customers. This is one of our major strengths together with supplying and supporting the resources needed at each different stage of a project.

#### **From a single product to the complexity of a power plant**

Close collaboration with the customer and every one of his partners and advisors is essential. We contribute actively and constructively from the very first enquiry in order to assure you the best possible solution – whether you need a single product or a full-scale project.



### **Advanced design**

Alfa Laval's extensive product development work has led to technologically advanced plates for heat exchangers that make it possible to adopt our "close approach" to energy efficiency. The optimized plate corrugation pattern not only increases heat transfer, but also reduces the risk of fouling thanks to highly turbulent flow. Plates are available in different materials and configurations to suit the customer's needs.

Alfa Laval's innovative heating and cooling systems are certified according to ISO 9001 and we have the possibility to control every component. As the interaction between all components is thoroughly tested, you can be sure to receive a reliable and cost-efficient system, ensuring lowest cost of ownership.

### **Leveraging local energy sources**

The availability of local energy is an important cost parameter in designing a system. By using heat exchangers from Alfa Laval, you can choose one or several of a wide variety of energy sources in order to maximize economic benefits and minimize environmental impact.

### **Full documentation**

We provide documentation and specifications consultants, contractors and end users. We can customize throughout the project – down to the smallest details of three-dimensional drawings.

### **Innovative solutions**

Alfa Laval pursues an active research and development policy at laboratories around the world. All Alfa Laval development projects are based on an analysis of the benefits of applying new technologies and the opportunities for even faster return on investment, reducing both the total operating cost and environmental impact.

### **We're closer than you think**

Alfa Laval is represented in most countries by local sales companies, and a network of regional authorized distributors are responsible for serving our customers at all times. All of our authorized distributors and sales companies are able to perform dimensioning of heat exchangers based on application, heat load and available space, and to provide installation guidelines together with full pricing details.

### **We understand and meet your needs**

There are many different ways to achieve reliable, economic temperature control. A thorough understanding of each individual situation, the available resources and the real needs is always the first step towards success.

### **Power and performance**

Alfa Laval has a full range of products catering for every need, however large or small. We offer versatile, compact and easy-to-install products that ensure high efficiency and low maintenance costs. Alfa Laval is your assurance of reliable operation, unsurpassed operating life span, fast return on investment and low cost of ownership.



# Chapter 3

1. The Alfa Laval Group
2. Heating and cooling solutions from Alfa Laval
- 3. Applications**
4. The theory behind heat transfer
5. Product range
6. Gasketed plate heat exchangers
7. Brazed plate heat exchangers
8. Fusion-bonded plate heat exchangers, AlfaNova
9. Air heat exchangers
10. All-welded heat exchangers
11. Filters





# Applications

In this chapter, we will illustrate a number of common applications of heat exchangers and heat-exchanger systems in industrial installations.

The diagrams and other information provided are intended only to clarify the operating principle. Actual systems must thus be completed with the components and accessories envisaged by current regulations.

For a more tailor-made design, contact your local Alfa Laval representative, who will be happy to provide you with professional assistance in selecting the best heat exchanger or heat-exchanger system for the job (see contact details at [www.alfalaval.com](http://www.alfalaval.com)).



# Metalworking/Automotive

## Metalworking

Metalworking is a vast industry covering a broad spectrum of process stages. These range from actually producing a metal to finishing an end-product, such as a door handle on a car or a cold drink can.

Correct temperature control of service fluids within the metalworking industry can have a huge impact on plant profitability. Service fluids are used in the process of shaping the metal as well as for cooling and lubricating machinery used for shaping metal materials.

The road from extracting metal mineral from rock to a finished product is very long and more or less every step needs some sort of cooling and heating.

When it comes to service fluids for metalworking, Alfa Laval has extensive process know-how that will save customers money.

## Automotive

Metalworking is closely connected to the Automotive and Vehicle industry and a large volume of the sheet metal and cast and finished components

produced are supplied to this industry. Not only is the automotive industry a large consumer of metal components, it is also an industry with very high quality demands. This is an advantage for Alfa Laval, a company which fulfills and leads all qualitative developments within plate heat exchanger manufacturing.

Alfa Laval also supplies temperature control solutions to many processes around the vehicle industry such as dynamometers, wind tunnels and engine testing.

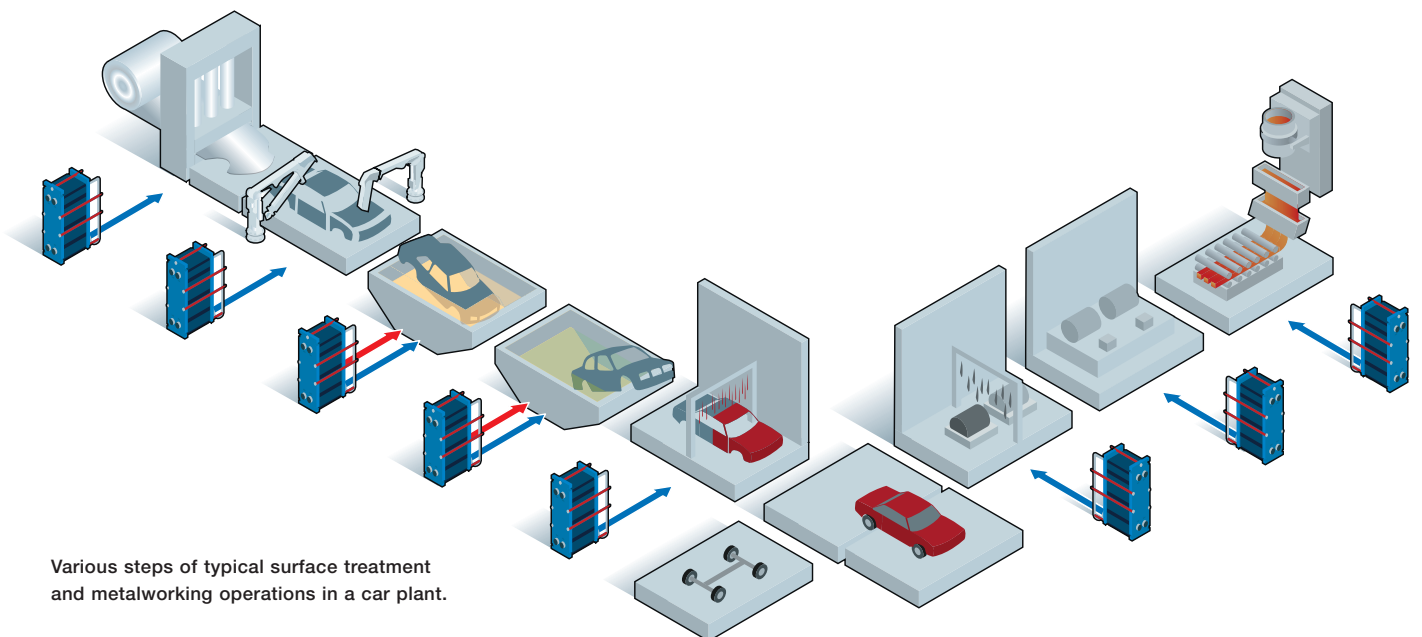



## From mineral to material

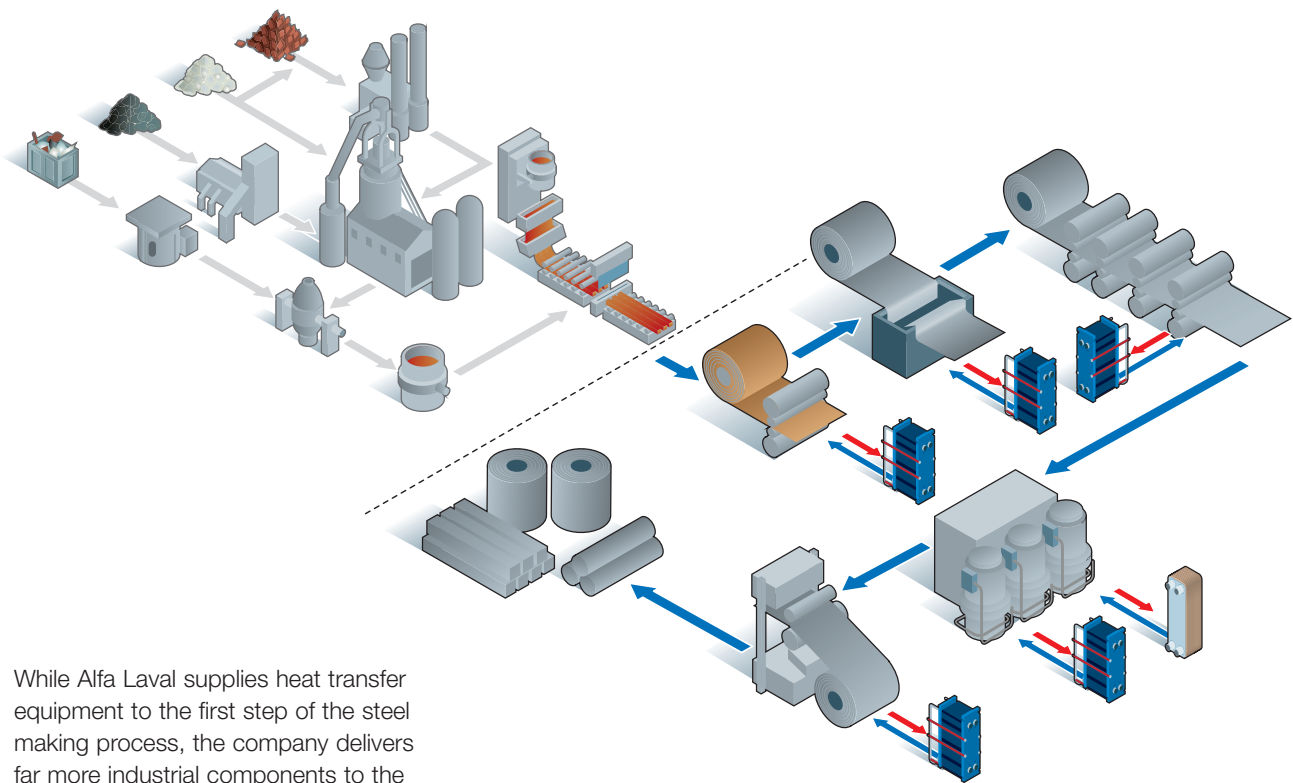

While Alfa Laval supplies heat transfer equipment to the first step of the steel making process, the company delivers far more industrial components to the second step where molten steel becomes a component. This is also the part where system builders around the world supply equipment for metal shaping. The majority of these systems and machines incorporate coolers and heaters of various kinds.

### Caster

In the caster molten steel is turned into solid slabs of steel and the most common casting process is continuous casting. From the ladle the molten steel flows into the tundish of a caster from where it then flows into the caster's water-cooled mould. As the steel travels down the caster, it solidifies with the help of water sprays. The steel comes out of the caster at the end of

the process in red-hot solid slab form, and is then cut to the desired length.

### Hot strip rolling mill

Rolling is the main method used to shape steel into different products. The rolling process consists of passing the steel between two rolls revolving at the same speed but in opposite directions. The gap between the rolls is smaller than the steel being rolled, so that the steel is reduced in thickness and at the same time lengthened. Two rolls opposite to each other together are called a "stand". A rolling mill may consist of up to 10 or more stands.

Hot rolling is a hot working process. Here a cast slab is converted into

sheets (which are often coiled at the end of the process). First the slabs from the caster are reheated in the re-heat furnace. After this they are moved, one by one, on a conveyor to the hot rolling mill. Here the slabs are rolled as often as necessary to reach the desired measures. After rolling, the steel is normally pickled to remove oxides from the surface. At this point, some products, such as steel plates, may be ready for shipping, but most of the products have to be further treated by a cold working process. This is often called cold rolling, but for wire and tubes drawing is also usual.





### **Pickling line**

Pickling prepares the surface for further processes. Pickling removes oxides from the surface by immersion in an acid bath. After this the acid is rinsed off and the steel is dried. As a final stage, the surface is oiled to protect further oxidation.

### **Cold strip rolling mill**

Cold rolling is a cold rolling process in which the steel sheets are made thinner and formed into the desired shape. The advantages of cold rolling compared to hot rolling are for example

better thickness tolerances and less oxidation. As a final stage and between cold rolling processes the steel may be annealed.

### **Annealing**

After the cold rolling process the steel is too hard and inflexible. Annealing makes the steel more suitable for forming and bending. Annealing is a heat or thermal treatment process. The steel is heated to a designated temperature for a sufficient amount of time and then cooled.

### **Products**

The final product from this industry can be a sheet, a bar (round or rectangular), a coil or a wire which will then be further worked on in various industries. The majority of the products will also be coated in one way or another. This is described further below.





## Premium metal components

Products from the metal making process are sold onward to companies which will add value to the product and sell it as a finished product. These companies normally perform one or more of the following operations:

**Alfa Laval supplies temperature control solutions for most of these processes, e.g.:**

- Anodizing
- Chromium plating
- Coolants
- Copper plating
- Cutting oil
- Degreasing
- Honing oil
- Hydraulic oil
- Lapping oil
- Lubrication oil
- Nickel plating
- Paint
- Passivating
- Phosphating
- Pickling
- Process water
- Quench oil
- Rolling oil
- Sintering oil
- Test bed oil
- Wash liquid
- Zinc plating

### Machining

The typical processes are cutting, turning, forming, pressing and drawing of the product. These operations require a lot of cooling and lubrication. The service fluids can be e.g., water-based coolants, neat oils or pressing emulsion and the functions of the fluids include:

- Cooling
  - cool the tool (wear)
  - cool the workpiece (measures)
  - cool the chips (breaking)
- Lubricating
  - between the tool and material
- Transportation of swarfs
  - prevent tearing of machine & tools
- Corrosion prevention

### Heat treatment

In the metallurgical, metal working and mechanical industry, a wide array of heat treatments is performed on

various metals. In many metal working processes the workpieces are heat treated to relieve stresses or to provide certain other desired surface properties. The process is normally divided into:

- Softening, which is normally achieved by heating and slow cooling (annealing, described earlier)
- Hardening, which is normally achieved by heating and rapid cooling (quenching, described below)

The service fluids identified with these two processes are normally oil and process water.

### Induction heating

Heating a metal in order to create the correct properties can be done by electromagnetic induction. This requires cooling of the electric rectifier and of the induction coil.

## Metalworking applications



### Machining

Cutting  
Forming  
Pressing  
Coolants Oil

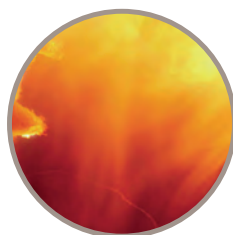

### Heat treatment

Quenching  
Annealing  
Quench Oil  
Process water



### Degreasing

Washing  
Degreasing  
Water  
Solvent



### Surface treatment

Phosphating  
Plating  
Anodizing  
Painting  
Acids  
Paint



### Automotive

Test Bed  
Dynameters  
Wind tunnels  
Oil  
Water  
Air





### Quenching

During forging, the metal part is heated to 800 - 900°C in a furnace. To cool the metal, avoiding oxidation, the work-piece is quenched in a tank filled with quench oil or water emulsion. Due to environmental controls and fire regulations, there is a trend in many countries to use synthetic oils instead of the traditional mineral oils.

The characteristics of the quenching fluid and its desired temperature vary according to the material and the type of workpieces that need to be quenched. Usually, baths are kept at a temperature in the range of 40 - 70°C,

in the manufacturing process, batch or continuous. A heat exchanger is needed to control the temperature of the quenching bath.

Special attention has to be paid to the clogging problem. Particularly when quenching steel pieces, large numbers of steel flakes or particles form a suspension together with the oil. In this case a PHE with a wide channel or a spiral heat exchanger may be chosen. Spiral heat exchangers not only overcome clogging but are also better protected against erosion. In some installations, water mixing with quench

oil can cause steam explosions. Therefore the customer wants to be absolutely sure that no leakage between the two fluids occurs. In these cases a double-wall PHE is often the preferred solution.

Alfa Laval can supply all these types of heat exchangers and several others, depending on the need within the application.

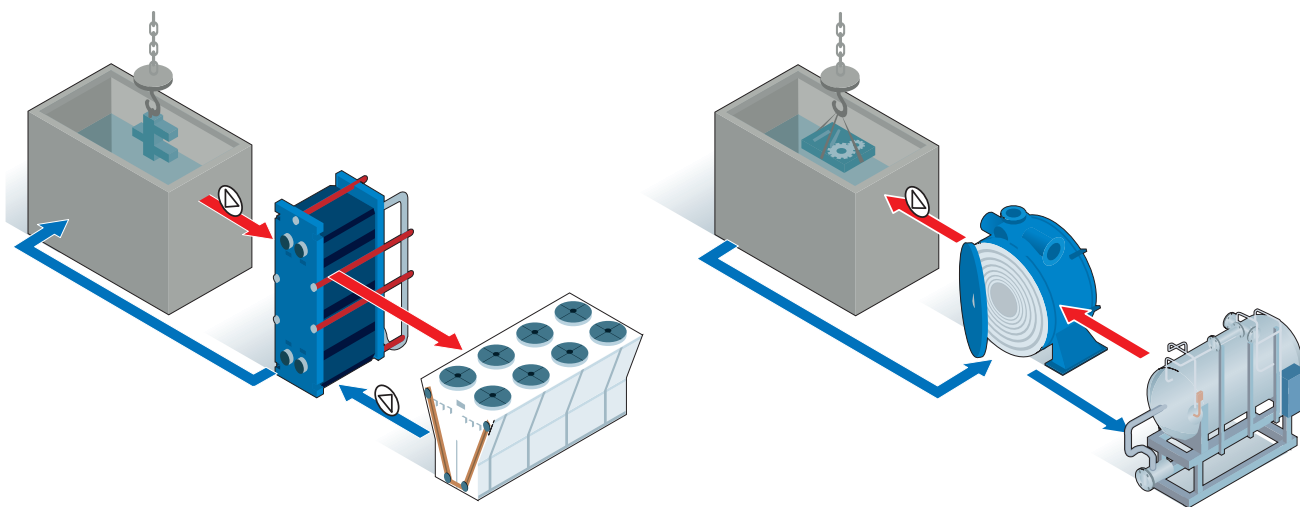

Cooling of quench oil utilizing a PHE for cleaner applications and a spiral heat exchanger for applications which carry a lot of dirt and particles.



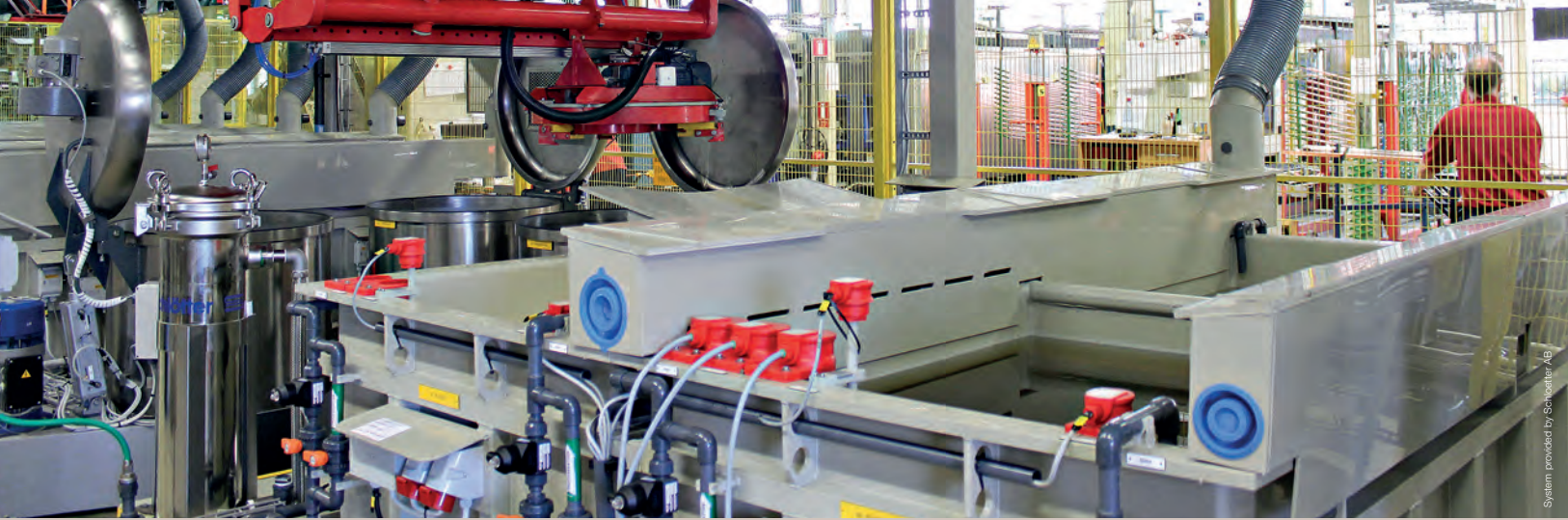

System provided by Schaeffler AB

**Surface treatment**

Surface treatment is a process where the surface of the metal parts is cleaned in order to add paint or (thin) metal layers for protection against wear and corrosion as well as for decorative purposes. Almost all operations involve fluids that need heating or cooling.

Due to the nature of metals, different metals are treated and coated differently, although all metals are first washed and degreased. The diagram below provides a guideline for the various steps following degreasing:

*Washing/degreasing*

The performance of the washing varies depending on machining conditions as well as the type of pollution, material, demands on degree of purity, etc. In general one or more wash steps are used followed by rinsing in one or more steps. If the product is highly polluted

there can be a pre-rinsing step before the washing process.

The type of wash liquids used depends on the type of pollution and the material of the workpiece. In general, water-based alkaline wash liquids are suitable for removing particles, while solvent-based wash liquids are suitable for removing fat and oil.

- Water-based wash liquids (alkaline)
  - pH from neutral to 14
  - Effective particle removal
  - Environmentally friendly
- Solvent-based wash liquids (acid)
  - pH 1 - 5.5
  - Effective fat and oil removal
  - Poor particle removal
  - Affects the environment
  - Suitable for aluminium and stainless steel

*Pickling*

Pickling is a process where oxides are removed from the surface of objects. This operation produces a smoother surface which will improve the results of phosphating and painting.

Many hot working processes and other processes that occur at high temperatures leave a discolouring oxide layer or scale on the surface. In order to remove the scale the workpiece is dipped into a tank of pickling liquid.

The most commonly used acid is hydrochloric acid, however sulfuric acid is also used. Hydrochloric acid is more expensive than sulfuric acid, but it pickles much faster while minimizing base metal loss. The speed is a requirement for integration in automatic steel mills that run production at high speed.

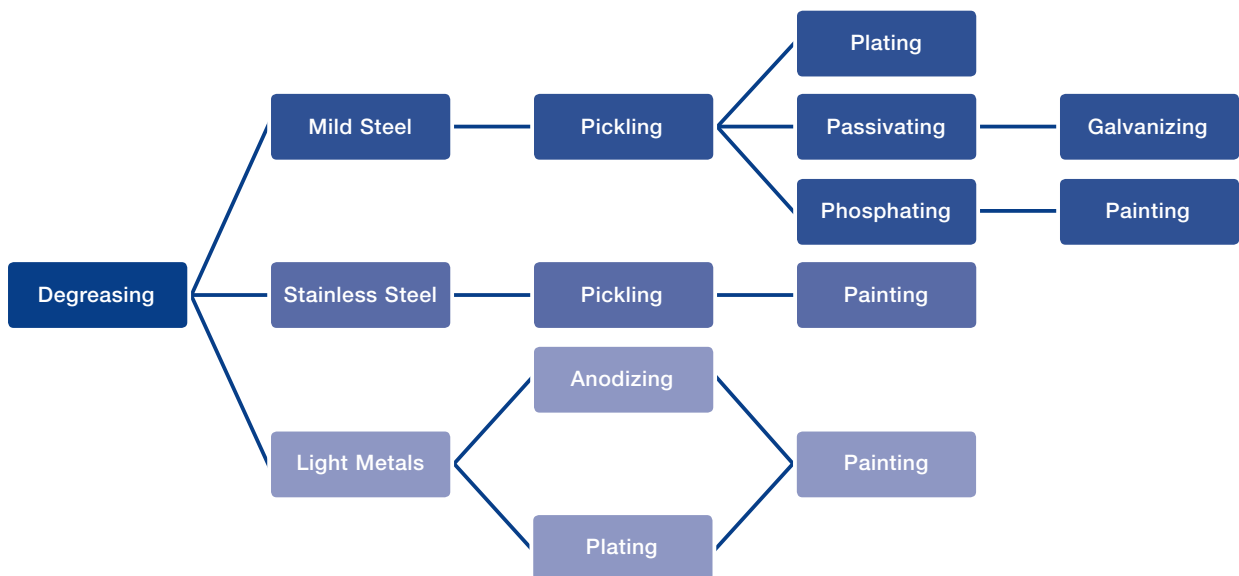



Carbon steels, with an alloy content less than or equal to 6%, are often pickled in hydrochloric or sulfuric acid. Steels with an alloy content greater than 6% must be pickled in two steps and other acids are used, such as phosphoric, nitric and hydrofluoric acid. Rust and acid resistant chromium-nickel steels are pickled in a bath of hydrochloric and nitric acid. Most copper alloys are pickled in dilute sulfuric acid, but brass is pickled in concentrated sulfuric and nitric acid mixed with sodium chloride and soot.

The duty conditions for this application can vary greatly. The heat exchanger duty is temperature control by heating. The traditional system design is to heat the bath with submerged heating coils. The objects can be lowered into the tank or sprayed with the liquid.

*Plating*

Plating creates a metal layer on the surface of a component, often by using an electrolytic process. The purpose is

to achieve hard and wear resistant surfaces (hard chromium plating) or to improve the finish on the object (decorative chromium, copper and nickel plating).

In the process the components to be plated are immersed in a solution called an electrolyte, containing one or more dissolved metals. A power supply supplies a current so that the dissolved metal ions in the electrolyte solution create a metallic layer on the components.

The plating metals can be combined in several layers, such as copper followed by nickel plating, or nickel followed by chrome plating.

*Passivating*

Passivating is performed to prevent oxidation. A thin layer of chromic acid is applied to the surface. The objects can be lowered into the tank or sprayed with the liquid. The heat exchanger duty is temperature control

by heating. The traditional system design is to heat the bath with submerged heating coils.

*Phosphating*

Phosphating of metals is one of the most important surface treatment methods and a number of modern metal finishing procedures would not be possible without it. The main areas of application of phosphating are:

- Corrosion protection in conjunction with organic coatings, e.g., paints and polymer films
- Facilitation of cold-forming processes, e.g., wire drawing and tube drawing, deep drawing
- Corrosion protection in conjunction with oils and waxes
- Corrosion protection with no subsequent treatment.

Of the many phosphating systems which have been proposed, the following are of industrial importance: zinc phosphate, iron phosphate, manganese phosphate. Such phosphating systems are predominantly applied to iron and steel, as well as zinc surfaces, whereas other metals which can be phosphated, e.g., aluminium or magnesium, are less commonly processed by this method.

Phosphate coatings which adhere well to the base metal and which, so far as possible, cover it completely, can only be formed on clean surfaces which are free from rust, scale and other corrosion products. Oil and grease films likewise inhibit phosphate coating formation, except when they are so thin that they are removed by an initial etching stage.

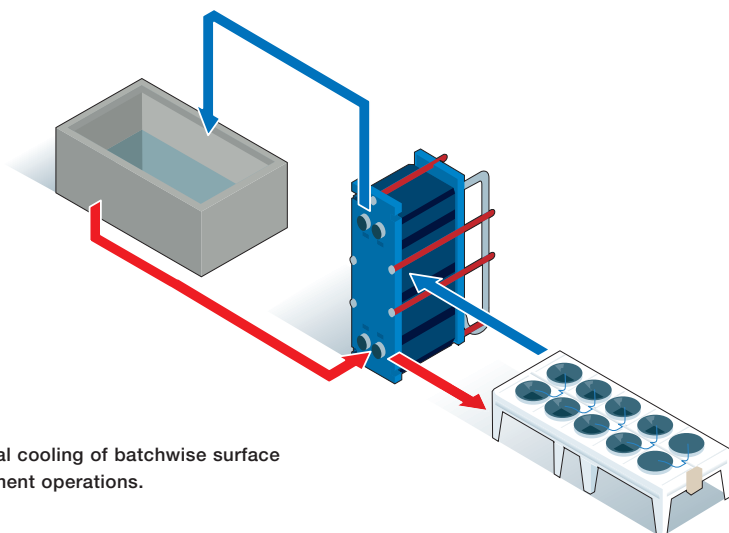

Typical cooling of batchwise surface treatment operations.



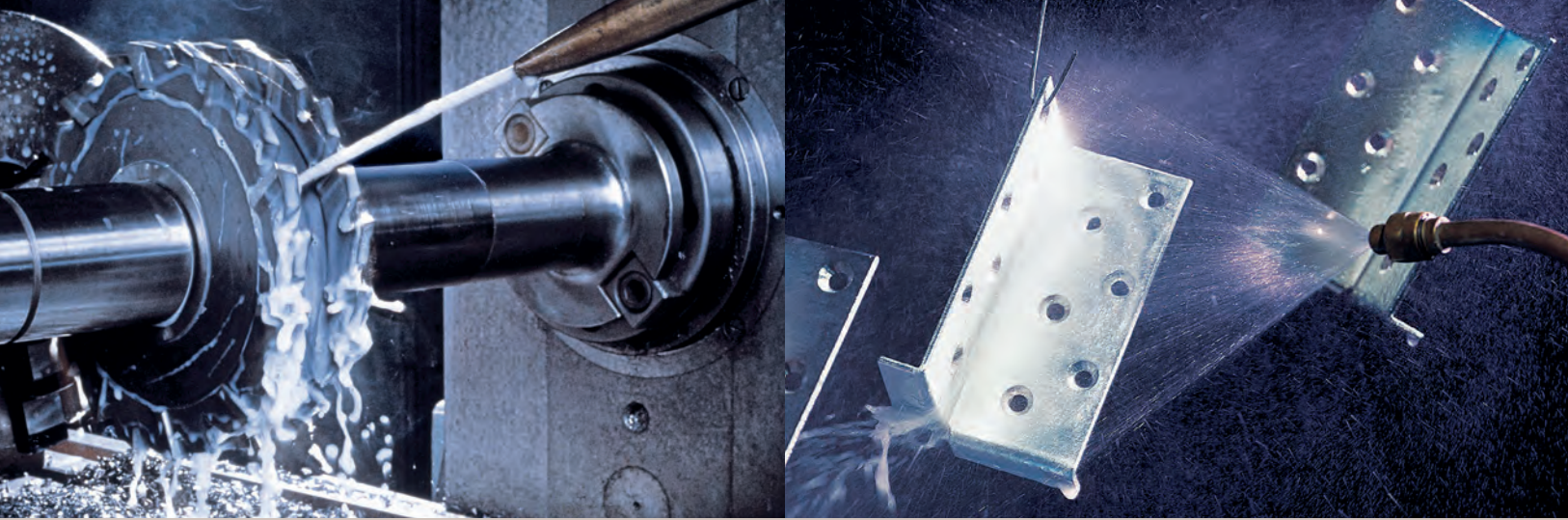

The phosphate solution is an application with a high risk of scaling. When the phosphating process is not in operation, the solution remaining in the PHE gets cold and a salt of zinc- or iron-phosphate will precipitate onto the plate surface. The salt is very hard and difficult to remove, resulting in a frequent need to open and clean the PHE. The wall temperature should be kept as low as possible to avoid deposits growing too fast on the heat surface. In this aspect zinc-phosphate solutions are more sensitive than iron-phosphate. A way to prevent deposit growths is to use recirculation on the hot side, making it possible to reduce the temperature on the hot side. If the customer wants to use steam as the heating media, it is advisable to install an intermediate PHE for heating of

water by means of steam. The heated water is then sent into the second PHE to heat the phosphating bath

#### Anodizing

Anodizing is an electrolytic process where objects are oxidated (covered by an oxide layer). Anodizing is used for light metals such as aluminium, magnesium, titanium and zinc to achieve higher corrosion and wear resistance or to obtain a decorative finish. The oxide layer provides an excellent basis for impregnation, colouring or painting.

Aluminium anodizing is usually performed in an acid solution which slowly dissolves the aluminium oxide. Conditions such as electrolyte concentration, acidity, solution

temperature, and current must be controlled to allow the formation of a consistent oxide layer. Other types of anodizing processes are:

- Chromic acid anodizing
- Sulfuric acid anodizing
- Organic acid anodizing
- Phosphoric acid anodizing

#### Galvanizing

Galvanization is the process of applying a protective zinc coating to steel or iron, in order to prevent corrosion. This can be achieved by hot-dip galvanization or by electro-galvanization (i.e., zinc plating). It is primarily the electrolytic process that is of interest for Alfa Laval, since it involves heating of the bath where components are treated.

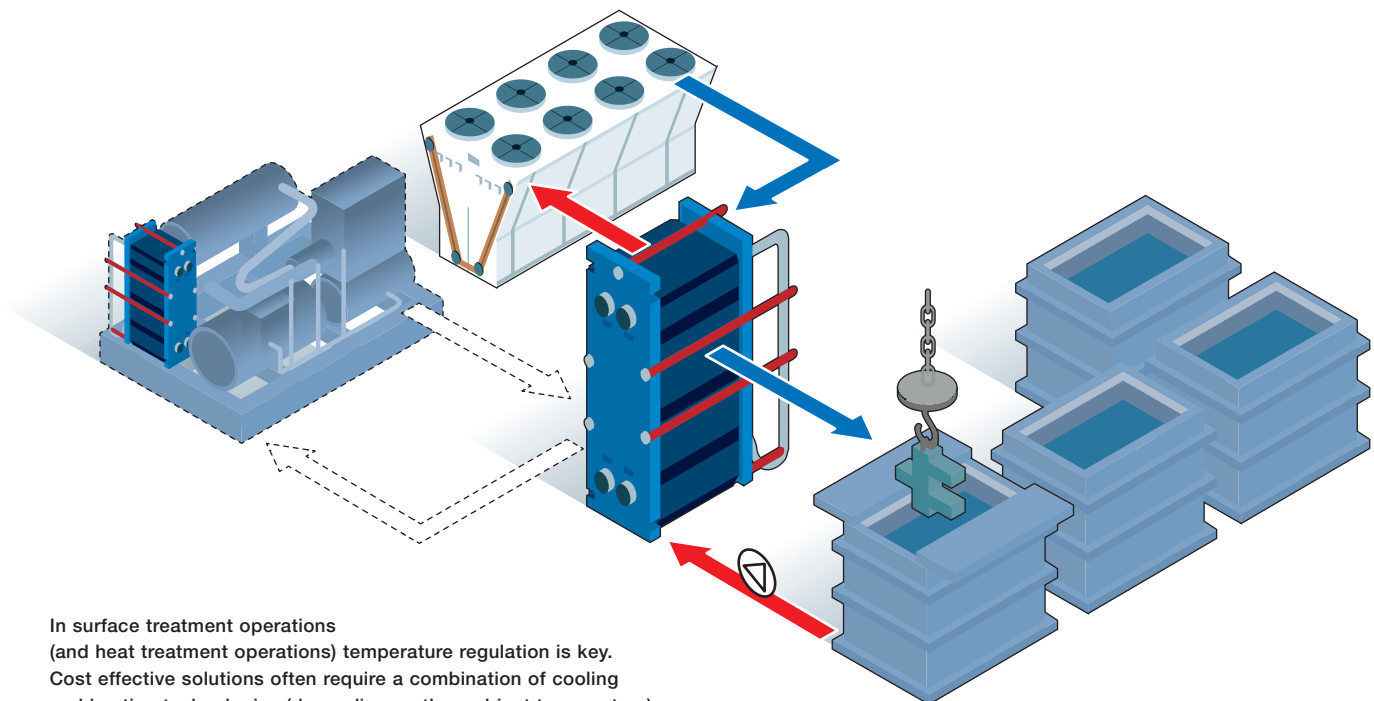

In surface treatment operations (and heat treatment operations) temperature regulation is key. Cost effective solutions often require a combination of cooling and heating technologies (depending on the ambient temperature).



### Painting

The painting process usually consists of three main steps:

- Adding a primer to prevent rust
- Adding a surfacer to ensure that the paint adheres and covers well
- Coating with a colour

Temperature control of the paint is of the utmost importance in order to provide the exact properties of the various coatings. Alfa Laval can supply many different heat exchangers matching different demands in this process. The unique Alfa Laval AlfaNova enables the paint companies

to handle the paint without any risk of contaminating copper ions.

### Heat exchangers in surface treatment

Surface treatment normally involves heating different process fluids in a number of tanks. This means that multiple heat exchangers are needed and in many cases utility coolers are also needed. A pump normally circulates the process fluid through the heat exchanger, which uses a cooling media, typically water. The cooling media can then, in turn, be cooled by a chiller or a radiator or both.

### Advantages of a Plate Heat Exchanger

The sizing of a heat exchanger is often based on heating a fluid in the tank, which is called a batch calculation. The most common heat exchanger in surface treatment is a simple coil. However, it is often an advantage to replace submerged coils with external heat exchangers.

The advantages include:

- Less tank and fluid volume required
- No risk of damaging the coils when objects move up and down in the tank
- Recirculation of the fluid gives stirring which decreases or eliminates the need for agitators
- Easier maintenance
- Stand-by unit possible (for service and breakdowns)

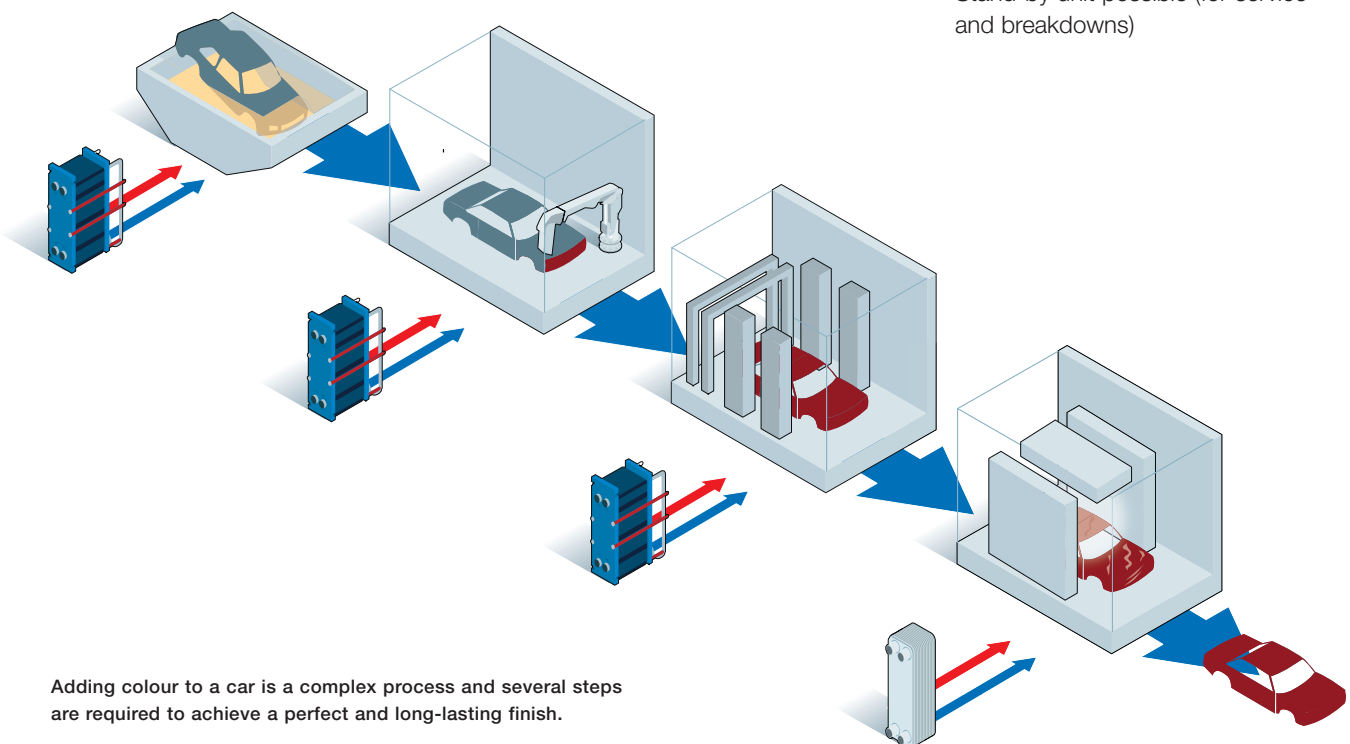





### **Automotive applications**

Modern vehicles have to meet increasingly demanding requirements relating to economical fuel consumption, low emissions and an enjoyable driving experience. In order to develop reliable solutions all the major vehicle manufacturers and their sub-suppliers have rigorous testing facilities where they simulate operation of each component. Most of these test benches and test rooms need temperature and climate control. Alfa Laval is a well-known supplier within this field supplying state-of-the-art technology with a small footprint and efficient heat transfer area.

*Choose the right technology and help save the planet*

Whatever the metalworking process, whatever the service fluid, water-based

or oil-based, accurate temperature control and efficient cleaning are essential to ensure end-product quality. Not every metalworking operation may include every process mentioned above but all processes involve water-based or oil-based service fluids – these fluids are in short supply and are even scarce in many places on the planet.

Energy efficient products and heat recovery are other factors that strongly influence total cost of ownership.

Combining these two parameters makes temperature control vital for a sustainable future.

# Fluid power

Fluid power is the use of fluids or air under pressure to generate, control, and transmit power

The main components of a typical basic hydraulic system are: a pump, a valve and a hydraulic cylinder. The pump converts a small amount of mechanical power into hydraulic power, the valve controls the hydraulic oil flow and the hydraulic cylinder converts the hydraulic power into a large amount of mechanical power.

**Why do hydraulic systems overheat?**  
Heating of hydraulic fluid in operation is caused by inefficiencies. Inefficiencies

result in losses of input power, which are converted to heat. A hydraulic system's heat load is equal to the total power lost (PL) through inefficiencies and can be expressed as:

$$PL_{total} = PL_{pump} + PL_{valves} + PL_{plumbing} + PL_{actuators}$$

If the total input power lost to heat is greater than the heat dissipated, the hydraulic system will eventually overheat. Installed cooling capacity typically ranges between 25 and 40 percent of input power, depending on the type of hydraulic system. The temperature of the hydraulic fluid



## Basic hydraulic system

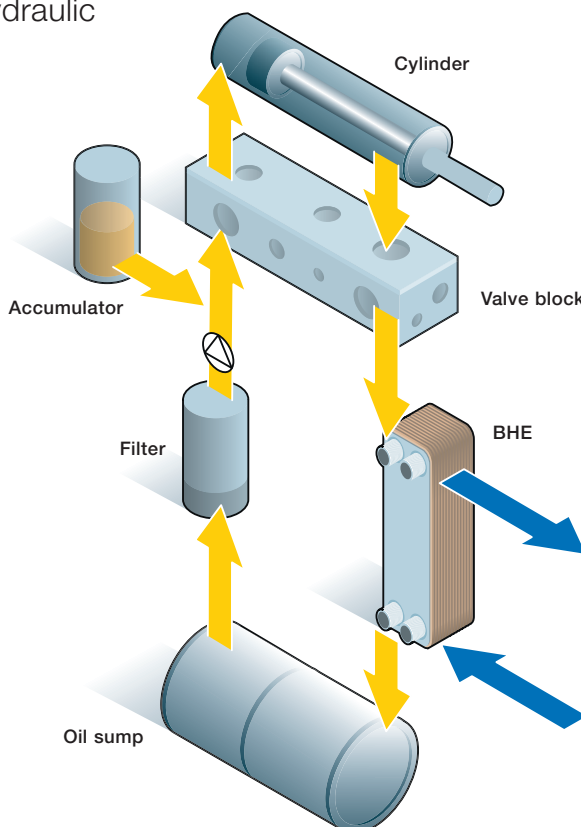

should not exceed 180°F (82°C). At higher temperatures, the fluid may start to deteriorate, and the viscosity gets too low for reliable lubrication of pump and motor components. It is very important that the fluid remains clean, stays below 180°F, and contains no water (less than 150 ppm) to secure a long oil life-time.

### Important facts:

- The operating temperature in most industrial applications is around 140°F (60°C)
- Operating at temperatures above 185°F (85°C) the oxidation process is accelerated.
- Oxidation stability is a chemical reaction that occurs with a combination of the oil and oxygen.
- Every 18°F (10°C) increase in temperature above 140°F (60°C) doubles the oxidation rate and cuts the life of the oil in half.



### Major fluid power users

#### Power pack manufacturers

Hydraulic power packs are stand-alone devices, as opposed to a built-in power supply for hydraulic machinery. Some power packs are large, stationary units and others are more portable. They have a hydraulic reservoir, which houses the fluid, regulators that allow users to control the amount of pressure the power pack delivers to a valve, pressure supply lines and relief lines, a pump and a motor to power the pump.

Hydraulic power packs typically offer a choice of valve connections, allowing users to connect them to a control valve or valves to power a variety of machines. The power pack supplies

hydraulic power through a control valve to run another machine.

#### Plastic industry

An injection moulding machine, also known as an injection press, is a machine for manufacturing plastic products by the injection moulding process. It consists of two main parts, an injection unit and a clamping unit. Types of injection moulding machines are classified primarily by the type of driving systems they use: hydraulic, mechanical, electric, or hybrid. Hydraulic machines, although not nearly as precise, are the predominant type in most parts of the world, with the exception of Japan.

There is also another part of the plastic machinery which is critical in terms of

temperature control – the tool making the plastic component. In larger facilities the cooling water which is used to cool the tools is centrally cooled by a cooling tower or a chiller station.







### Gearbox

Most modern gearboxes are used to increase torque while reducing the speed of a prime mover output shaft (e.g., a motor crankshaft). This means that the output shaft of a gearbox rotates at a slower rate than the input shaft, and this reduction in speed produces a mechanical advantage, increasing torque. A gearbox can be set up to do the opposite and provide an increase in shaft speed with a reduction of torque. Some of the simplest gearboxes merely change the physical direction of power transmission. Gearboxes have found use in a wide variety of different – often stationary – applications, such as wind turbines

### Hydraulic presses

A hydraulic press is a machine using a hydraulic cylinder to generate a compressive force. It uses the hydraulic equivalent of a mechanical lever. The hydraulic press depends on Pascal's principle: the pressure throughout a closed system is constant. One part of the system is a piston acting as a pump, with a modest mechanical force acting on a small cross-sectional area; the other part is a piston with a larger area which generates a correspondingly large mechanical force. Only small-diameter tubing (which more easily resists pressure) is needed if the pump is separated from the press cylinder. A fluid, such as oil, is displaced when either piston is pushed

inward. The small piston, for a given distance of movement, displaces a smaller amount of volume than the large piston, which is proportional to the ratio of areas of the heads of the pistons. Therefore, the small piston must be moved a large distance to get the large piston to move significantly. The distance the large piston will move is the distance that the small piston is moved divided by the ratio of the areas of the heads of the pistons. This is how energy, in the form of work in this case, is conserved and the Law of Conservation of Energy is satisfied. Work is force times distance, and since the force is increased on the larger piston, the distance the force is applied over must be decreased.

### Gearbox

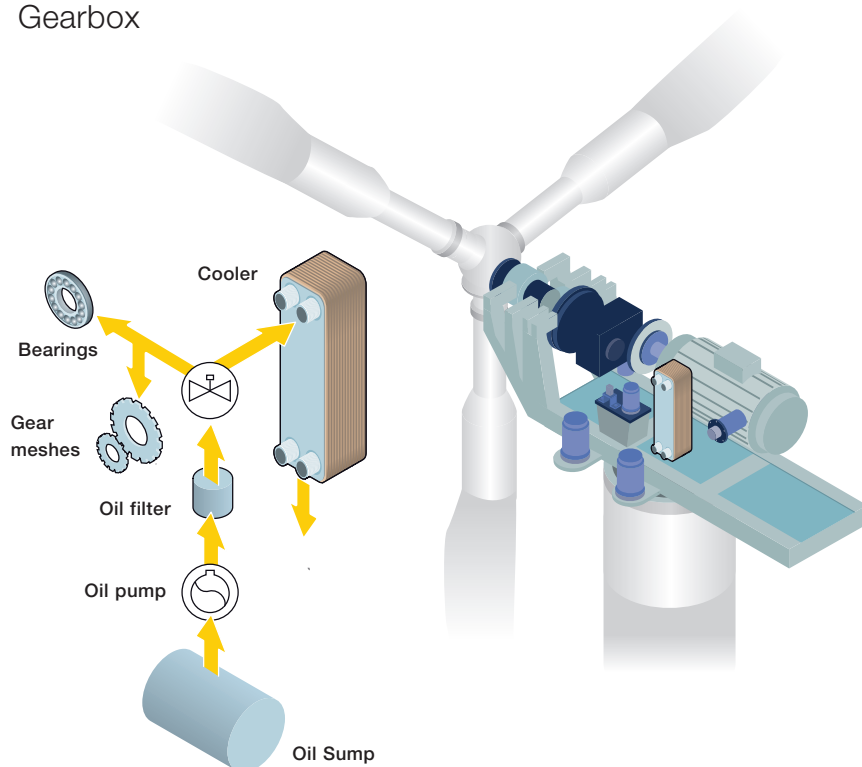

Hydraulic presses are commonly used for forging of metal parts.

### Machines for the paper industry

In the paper industry there are several machines needed for rolling and pressing paper.





### **Machine tools**

A machine tool is a machine for shaping or machining metal or other rigid materials, usually by cutting, boring, grinding, shearing or other forms of deformation. Machine tools employ some sort of tool that does the cutting or shaping. All machine tools have some means of constraining the workpiece and provide a guided movement of the parts of the machine. Thus the relative movement between the workpiece and the cutting tool (which is called the toolpath) is controlled or constrained by the machine to at least some extent, rather than being entirely “offhand” or “freehand”. Today machine tools are typically powered electrically or hydraulically

### **Marine hydraulic systems**

Nowadays sea travel without hydraulics is unthinkable. Hydraulic drive systems are used to power essential operational units on ships. Titanium plate heat exchangers are perfect coolers when using seawater as the cooling medium.

There are many applications on board, such as:

Winches, cranes, thrusters and propeller drives, bow and stern doors, lifts, waterjet and cargo pumps.

### **Fire fighting equipment**

Conventional and FPSO offshore production platforms require fire protection, which is typically achieved by a high-pressure firewater ring main supplied by a firewater pump.

Traditionally, these are conventional, vertical line-shaft pumps driven by a diesel engine via a 90° gearbox. By making an innovative hydraulic drive fire pump design a number of cost-effective improvements have been made to this key application.

### **Mining equipment**

Heavy machinery is needed in mining for exploration and development, to remove and stockpile overburden, to break and remove rocks of various hardness and toughness, to process the ore and for reclamation efforts after the mine is closed. Bulldozers, drills, explosives and trucks are all necessary for excavating the land. Processing plants can utilize large crushers, mills, reactors, roasters and other equipment to consolidate the mineral-rich material and extract the desired compounds and metals from the ore.

Hydraulic Marine application

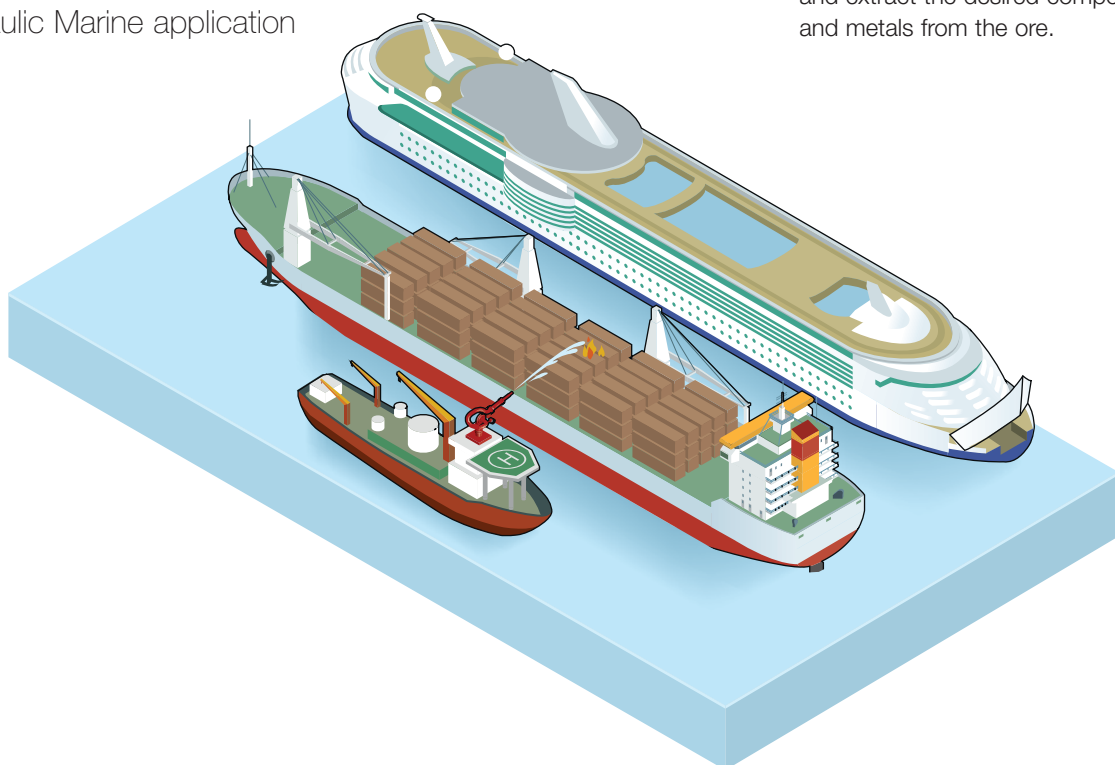

# Steam heaters

## What is steam?

Water can exist in the form of a solid, which we call ice, as a liquid, which we call water, or as a gas which we call steam. If heat energy is added to water, its temperature rises to a point at which it can no longer exist as a liquid. This is called the “saturation” point and any further addition of energy will cause some of the water to boil off as steam. This evaporation of the water into steam requires large amounts of energy, and while it is being added, the water and the steam released are at the same temperature.

If we then encourage the steam to release the energy that was originally added to evaporate it, the steam will condense back into water at the same temperature. A heat exchanger is where we arrange for this release of energy to take place.

### Why use steam?

Steam has been used as a carrier of heat since the Industrial Revolution and continues to be a modern, flexible and versatile tool wherever heating is needed.

- It is produced by the evaporation of water; a relatively inexpensive and plentiful commodity which is environmentally friendly.
- Its temperature can be adjusted very accurately by controlling its pressure.
- It carries a large amount of energy in a small mass.

### Types of heating

Before it is possible to select a correctly sized steam control valve, a supply main, or even a steam boiler, it is necessary to know, with as much accuracy as possible, how much

steam is required. Almost all heating loads fall into one of two categories.

- Temperature increase - heating a material from a lower temperature to a higher temperature.
- Temperature maintenance - making up heat losses to maintain a fixed temperature.

Normally, in the case of a steam heat exchange application it is the former case, with a product entering the secondary side of the exchanger at a lower temperature and leaving at a higher temperature.

### Steam load on heat exchangers

When considering the actual steam load on a heat exchanger, enough steam needs to be provided to the primary side of the exchanger to

## Steam heater

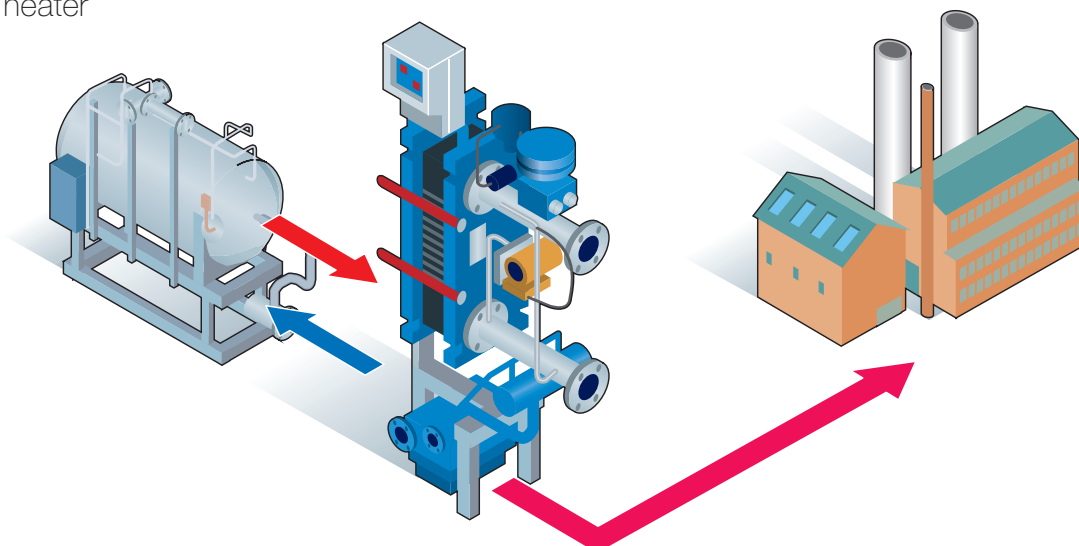





provide the required rise in temperature in the liquid or gas passing through the secondary side of the exchanger.

Usually, you will be provided with a flow rate for the secondary fluid and the required rise in temperature. Sometimes the heat requirement in a heat exchange application will be expressed as an energy rate requirement given in kilowatts (kW) or megawatts (MW). A Watt is an energy rate of 1 Joule per second (J/sec), where the Joule is a basic unit of energy. If heat requirements are expressed in these units, they can be converted to steam flow rates using various formulas. Please find out more on [www.alfalaval.com](http://www.alfalaval.com).

It must always be remembered that even if the correct amount of steam is provided, in the best possible condition, the required secondary condition will not be met if the exchanger itself is undersized. The ability of an exchanger to meet a given condition can be checked if the heat exchange area and heat transfer coefficient are known.

### Steam systems

A steam system will normally consist of four main elements, all of which can affect the efficient operation of each individual piece of steam using equipment.

- Steam generation
- Steam distribution
- Steam consuming equipment
- Condensate recovery and return

The purpose of the steam generation and distribution system is to provide steam at the correct pressure, in sufficient quantity and in the best possible condition to the equipment.

The steam users should be provided with the steam control and condensate removal equipment that allow them to operate efficiently. The condensate recovery and return system should remove condensate effectively from the equipment and ensure that it is returned to the boilerhouse to be re-used in the boiler.

Alfa Laval has developed a series of plate heat exchangers specially designed for heating water using industrial steam. The major features of this series are the unique geometry and strength of the stainless steel plates, special gaskets that tolerate temperatures up to 180°C (356°F), and the robust heat exchanger frame. Together, these features provide operational economy and performance unmatched by either shell-and-tube heat exchangers or conventional plate heat exchangers.

### Typical steam industries

Steam is used in most types of industry and a lot of machinery uses the great features of steam. Examples are:

- General manufacturing
- Chemical processing
- HVAC for heating
- Bottling, filling and sterilization of food and beverages
- Pharmaceutical, e.g., autoclaves



# Semiconductor industry

## Heat transfer solutions for the semiconductor manufacturing industry

In the microelectronics industry a semiconductor fabrication plant (commonly called a fab) is a factory where devices such as integrated circuits are manufactured. A business that operates a semiconductor fab for the purpose of fabricating the designs of other companies, such as fabless semiconductor companies, is known as a foundry. If a foundry does not also produce its own designs, it is known as a pure-play semiconductor foundry.

Fabs require many expensive devices to function. The central part of a fab is

the cleanroom, an area where the environment is controlled to eliminate all dust – even a single speck can ruin a microcircuit, which has features much smaller than dust. The cleanroom must also be dampened against vibration and kept within narrow bands of temperature and humidity.

Controlling temperature and humidity is critical for minimizing static electricity.

The following applications are all manufactured in a semicon fab:

**Microchips:** Manufacturing of chips with integrated circuits.

**LED lighting:** Manufacturing of LED lamps for lighting purposes.

**PV industry:** Manufacturing of solar cells, based on Si wafer technology or thin film technology.

**Flat panel displays:** Manufacturing of flat panels for everything from mobile phones and other handheld devices, up to large size TV monitors.

**Electronics:** Manufacturing of printed circuit boards (PCB), computer and electronic components.

## Semiconductor plant

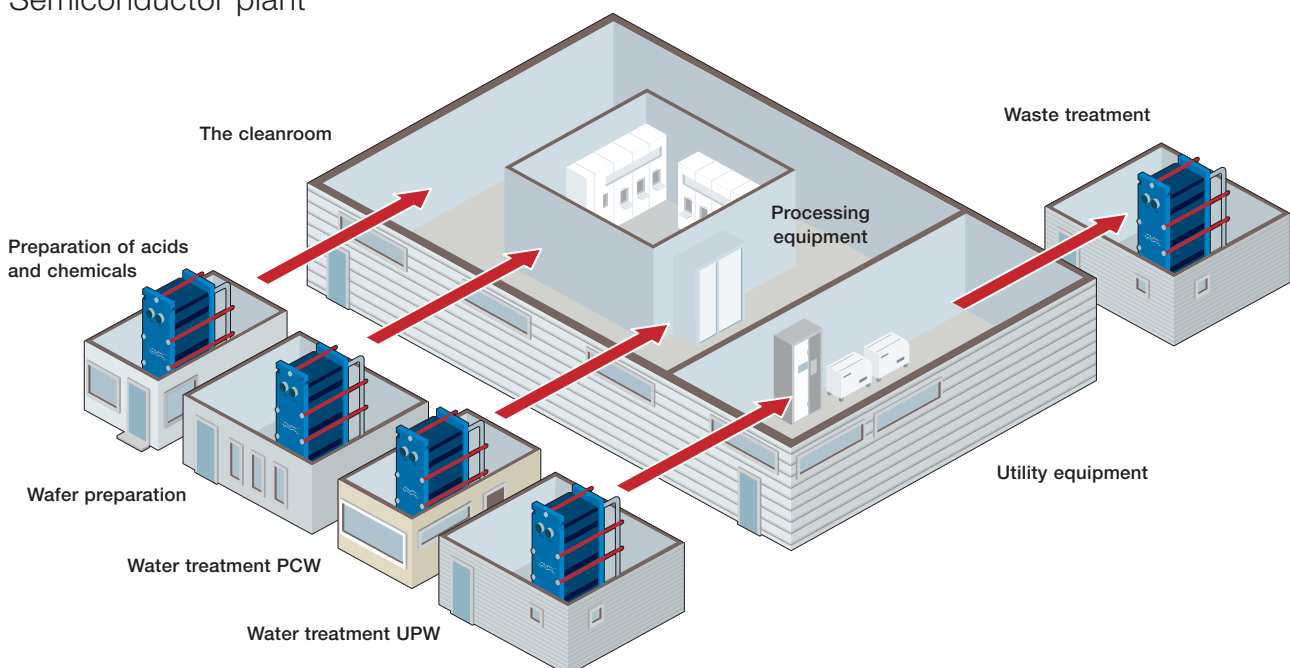



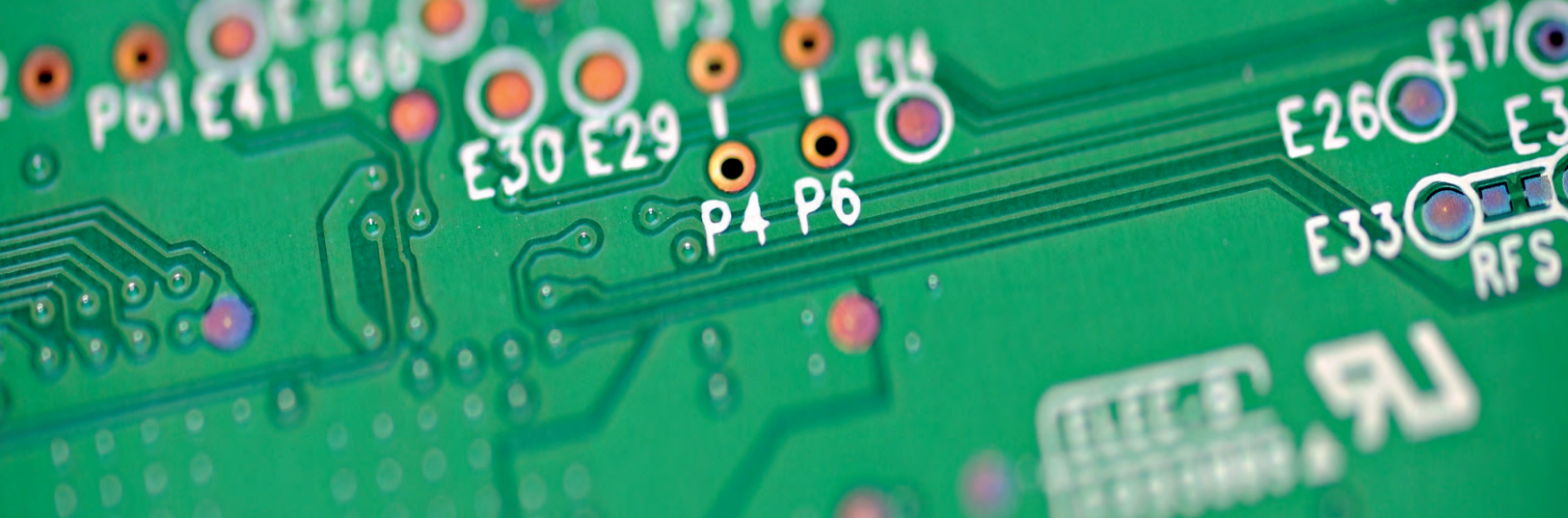

The principal layout and functions of the fab are similar in all the industries.

*The cleanroom:* This is the central part of the plant where the actual manufacturing takes place. The substrate (wafer for microchip, solar cell, flat screen, or LED) goes through several processing steps in various processing machinery, "tools". The manufacturing of microchips is the most complex with numerous processing steps, while a solar cell

would be the least complex, requiring only a few processing steps.

*Utility equipment:* This includes vacuum pumps, maintaining the vacuum that is often required in the processing tools, scrubbers that clean the exhaust from the vacuum pumps, and chillers that provide cooling for the processing tools and utility equipment.

Alfa Laval heat exchangers come in a variety of materials, sizes and

capacities. Unique materials combined with Alfa Laval's expertise in materials selection ensure highest purity operations, reduction in contamination of ultrapure water, resistance to aggressive media, and long materials lifetime. Whatever the duty in your semiconductor plant, Alfa Laval has precisely the right heat exchanger to match your needs.

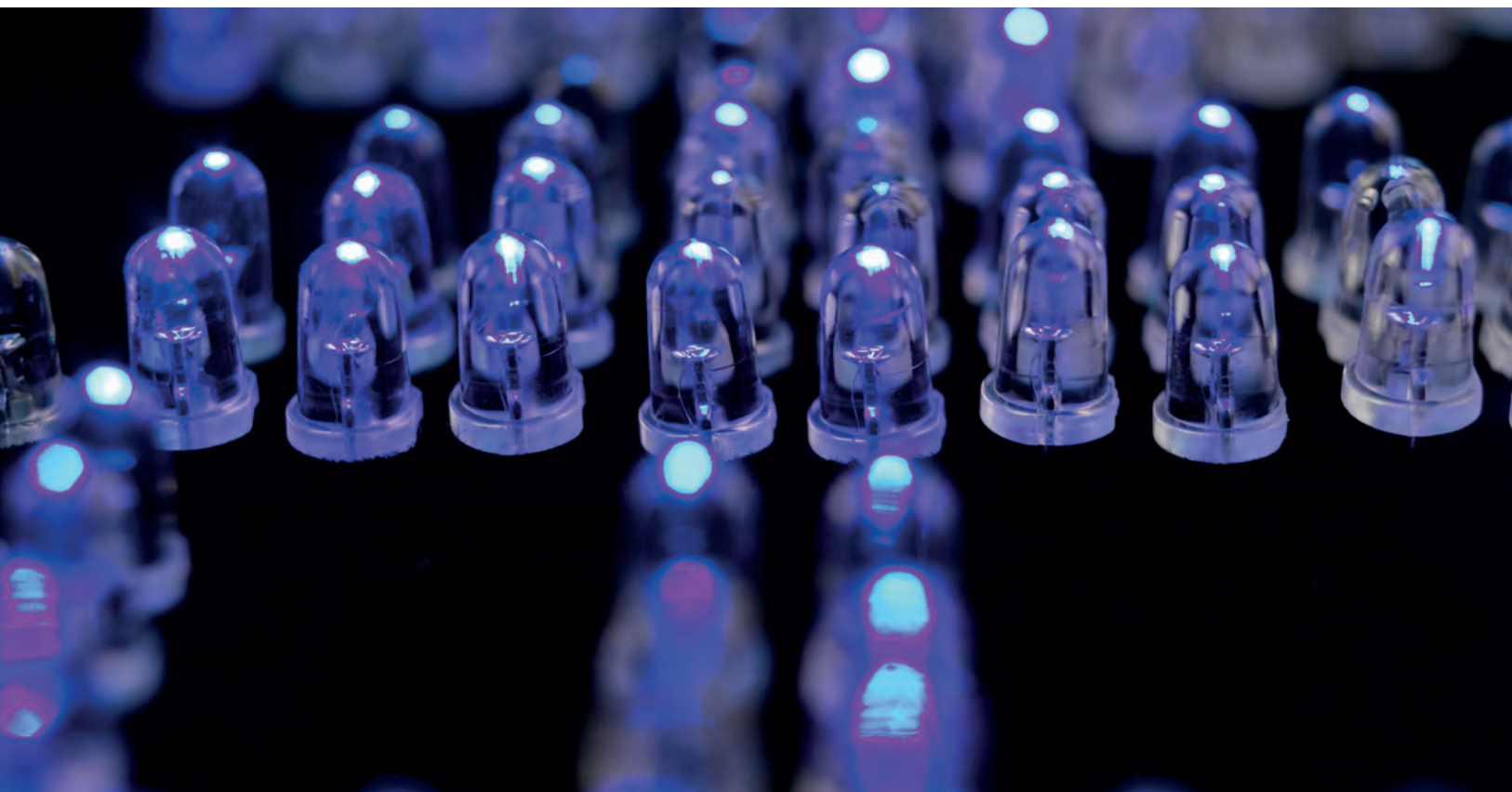





## Wafer preparation

In electronics, a wafer is a thin slice of semiconductor material, such as a silicon crystal, used in the fabrication of integrated circuits and other micro-devices.

The wafer serves as the substrate for microelectronic devices built in and over the wafer and undergoes many microfabrication process steps, such as doping or ion implantation, etching, deposition of various materials, and photolithographic patterning. Finally the individual microcircuits are separated (dicing) and packaged.

When cutting Si ingots into wafers using wire saws it is necessary to cool

the coolant/cutting slurry. Suitable solutions from Alfa Laval's heat exchanger range are gasketed plate heat exchangers, AlfaNova all-stainless steel heat exchangers, and brazed heat exchangers. All are compact, reliable and offer high heat transfer efficiency.

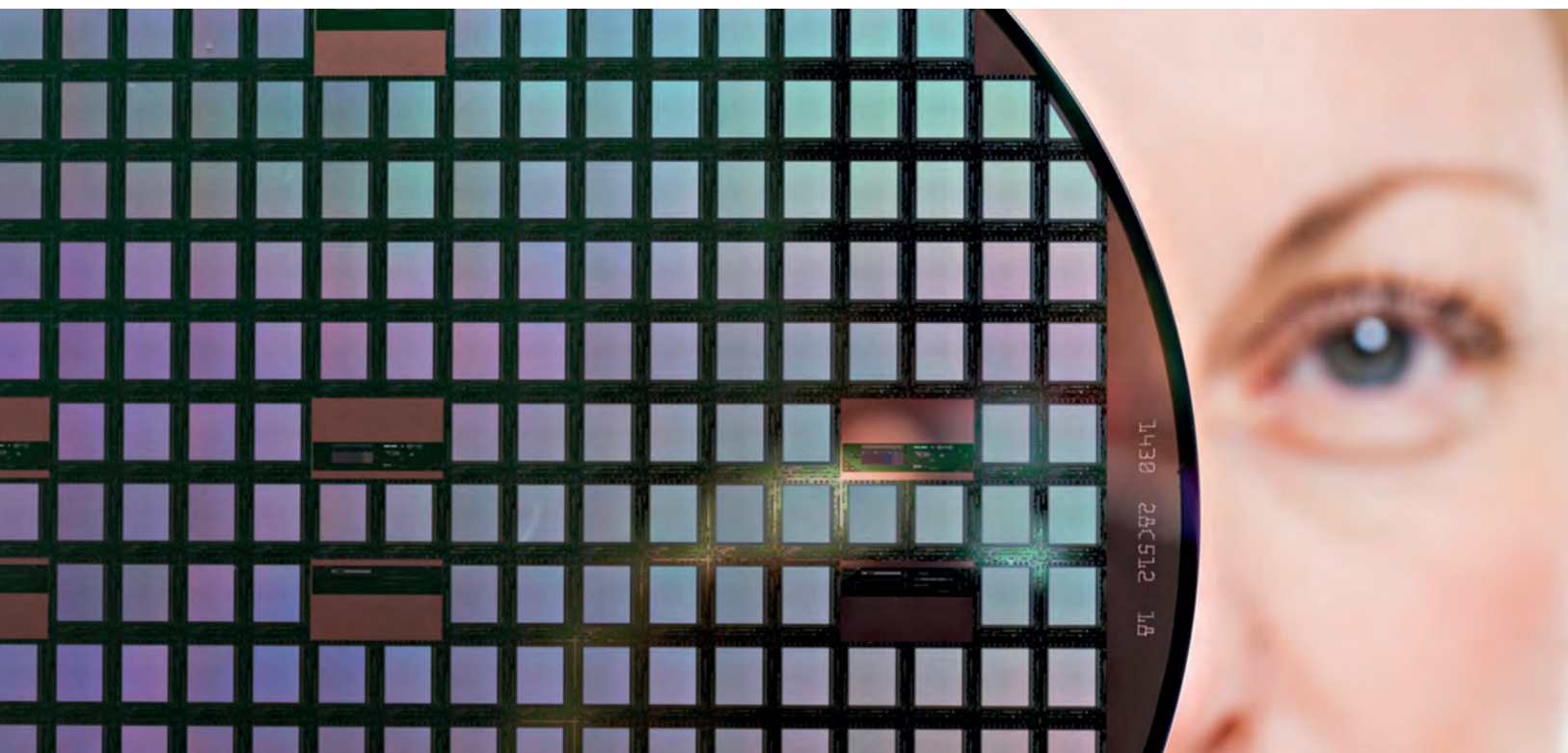
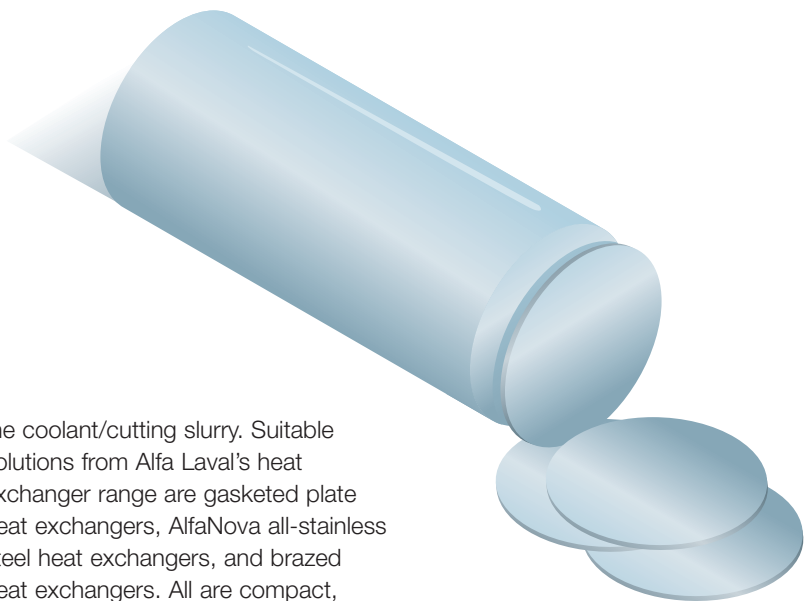





## Preparation of acids and chemicals

Industrial etching is the subtractive manufacturing process of using baths of temperature-regulated etching chemicals to remove material to create an object with the desired shape. It is mostly used on metals, although other materials are increasingly important. It was developed from armour-decorating and printing etching processes

developed during the Renaissance as alternatives to engraving on metal. The process essentially involves bathing the cutting areas in a corrosive chemical known as an etchant, which reacts with the material in the area to be cut and causes the solid material to be dissolved; inert substances known as

maskants are used to etch specific areas of the material. Today one of the most common applications for etching is in the semiconductor fabs when preparing acids and chemicals before and inside the cleanroom.

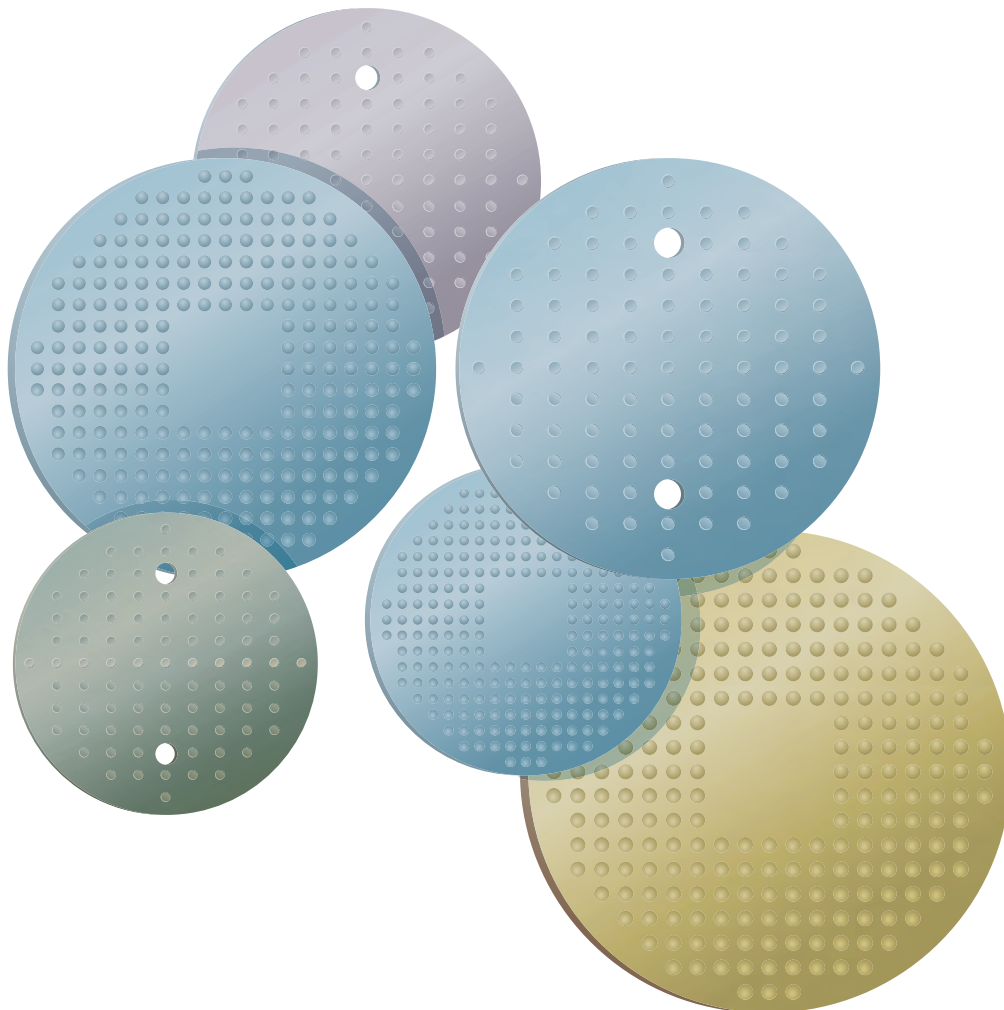

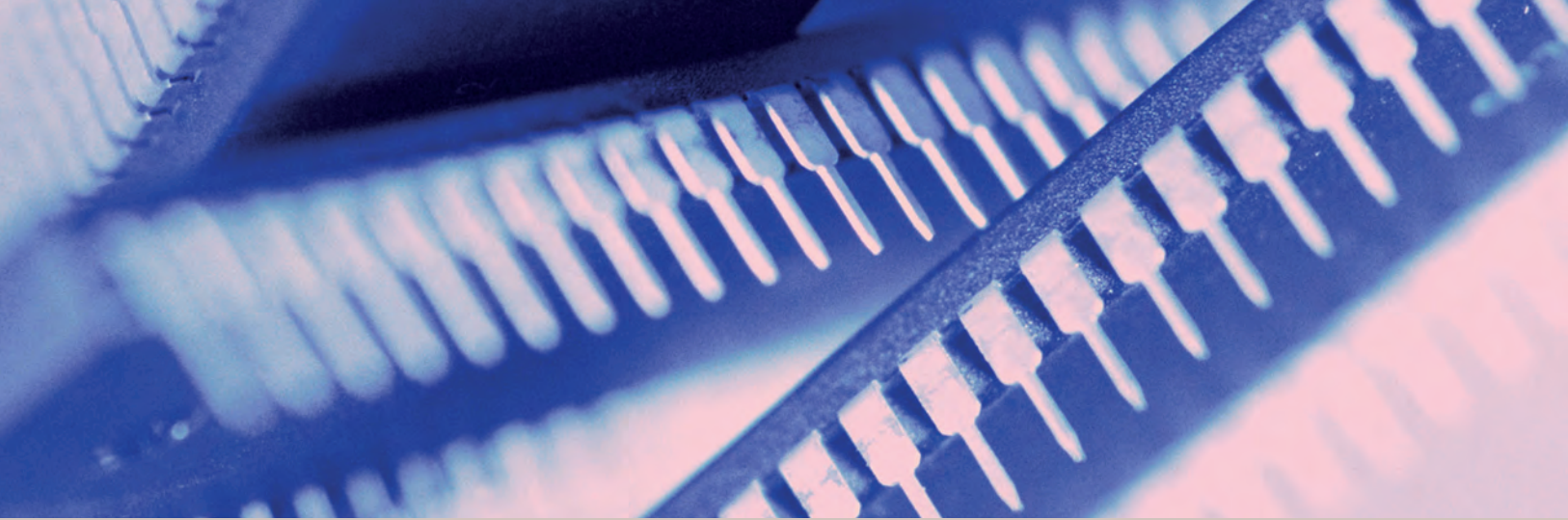

## Water treatment

Water treatment of ultrapure water (UPW) and process cooling water (PCW) is necessary in order to control the temperature of all the various manufacturing steps. General manufacturing in the semiconductor industry consumes large amounts of water, which need to be at the correct temperature. In Alfa Laval's broad portfolio of plate heat exchangers you will find models that cater to the specific needs of any duty.

The illustrations on the right show the various "water consumers".

Ultrapure water (UPW) is used extensively in the fabrication steps of making computer microchips. Ultrapure water is needed to ensure the cleanliness of critical process steps, where regular PCW cannot be used. Using Alfa Laval's all welded plate exchangers with titanium plates the cleanliness of the ultrapure water can still be guaranteed.

### The cleanroom

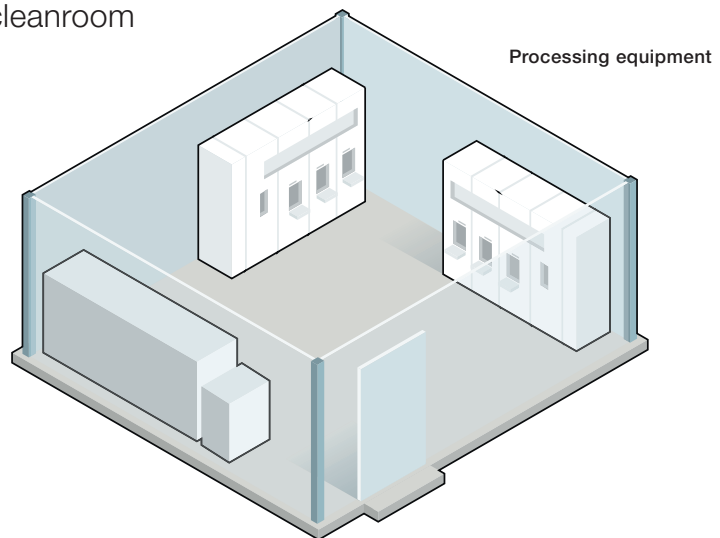

### Utility equipment

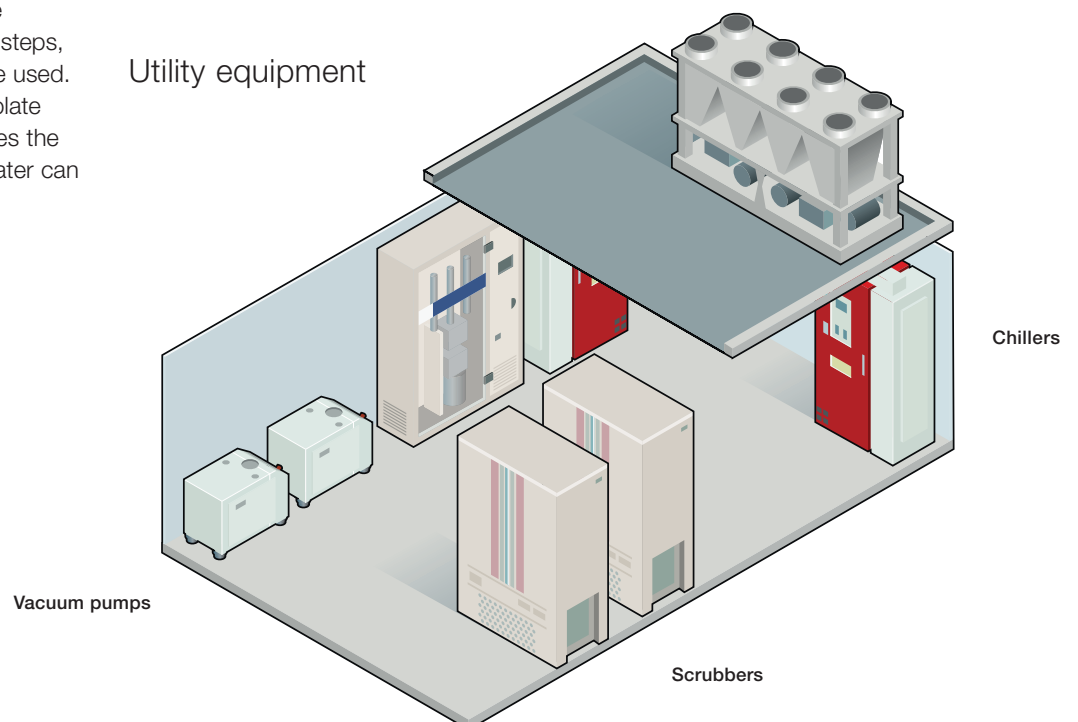



# Compressor cooling

## Compressed air – the fourth utility

A gas compressor is a mechanical device that converts power into kinetic energy by increasing the pressure of gas and reducing its volume.

Compressed air has become one of the most important power media used in industry providing power for a multitude of manufacturing operations. In industry, compressed air is so widely used that it is often regarded as the fourth utility, after electricity, natural gas and water. General uses of

compressed air are pneumatic tools, energy storage, production lines, automated assembly stations, refrigeration, gas dusters and air-start systems.

Another important power media is compressed natural gas (CNG), which is made by compressing natural gas to less than 1% of the volume it occupies at standard atmospheric pressure. CNG is generally used in traditional combustion engines.

The major cooling applications for compressors where heat exchangers are used are:

- Air cooling
- Oil cooling
- Water cooling
- Heat recovery





## Oil-free

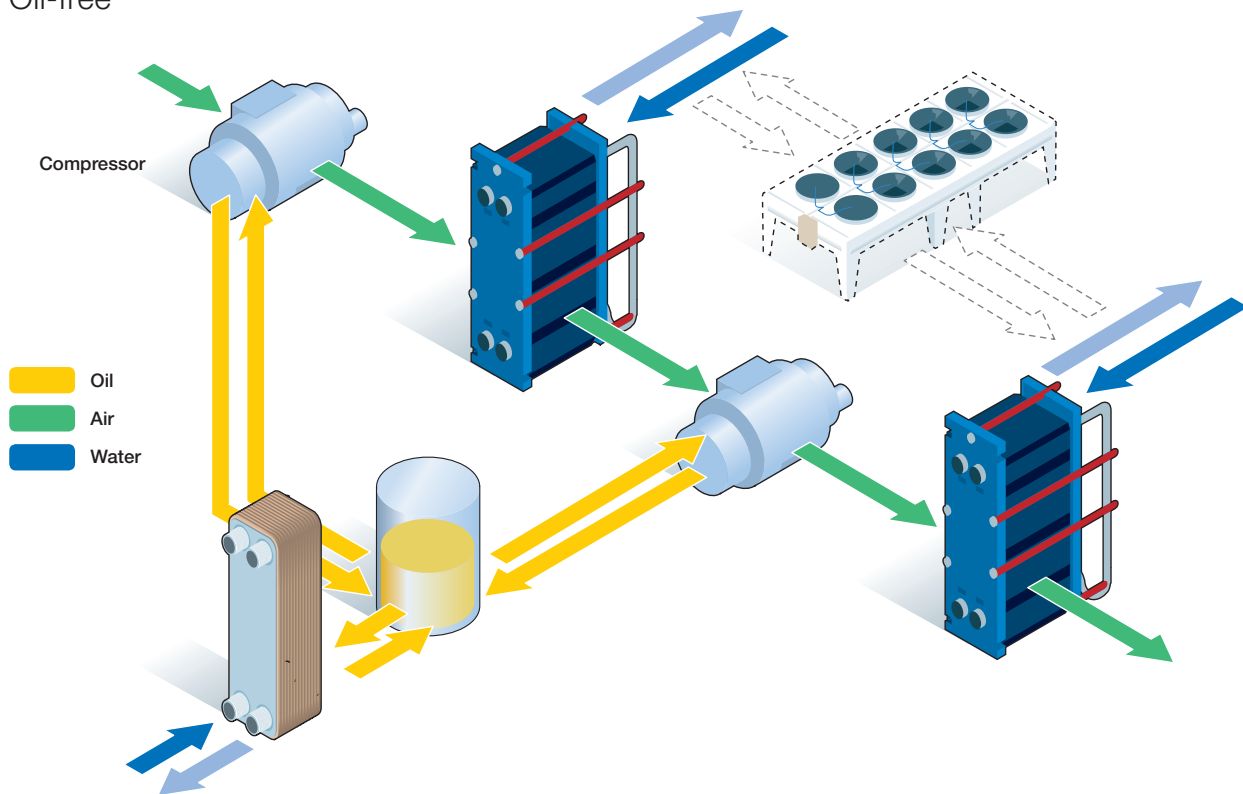

### Air cooling

A multi-stage compressor can contain one or several intercoolers. Since compression generates heat, the compressed gas needs to be cooled between stages, making the compression less adiabatic and more isothermal. The inter-stage coolers typically result in some partial condensation that is removed in vapor-liquid separators.

The compressed gas from the compressor is hot after compression, often 70-200°C. An aftercooler is used to lower the temperature, which also results in condensation. The aftercooler is placed directly after the compressor in order to precipitate the main part of the condensate as quickly as possible that would otherwise follow out into the system. The aftercooler is generally fitted with a vapor-liquid separator with automatic drainage.

### Oil cooling

Both lubricated and oil-free compressors need oil cooling. In oil-free compressors it is the lubrication oil for the gearbox that has to be cooled. In oil-injected compressors it is the oil which is mixed with the compressed air for lubrication, sealing and cooling that has to be cooled.





## Oil-injected

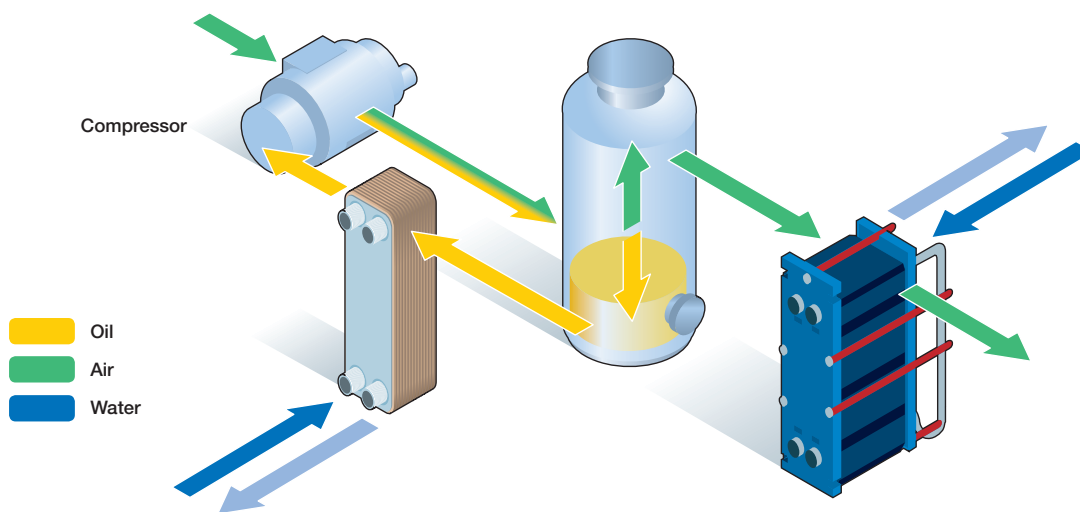

### Water cooling

A water cooler is generally used, direct or indirect, to cool the closed loop cooling water to the air/gas and oil coolers. Since this is typically an outdoor installed air heat exchanger, the water is mixed with anti-freeze such as glycol. This is a common cooling method for CNG compressors. Air heat exchangers are particularly suitable when the availability of water is limited or as an alternative to cooling towers. As air heat exchangers have a closed cooling water loop – make-up water, water contamination and chemicals to prevent algae can be avoided.

### Heat recovery

When a gas is compressed heat is emitted. The thermal energy is

concentrated in the decreasing volume and the excess is led off before the gas leaves the compressor. The energy used to produce compressed air or gas typically represents 80% of the total cost. Over 90% of the energy supplied to the compressor can be recovered.

For water cooled compressors, the cooling water from the compressor can supplement a hot water flow. If the water is used for e.g., washing, cleaning or showers, a normal hot water boiler is still required. However, the recovered heat is a supplement that can reduce the load on the boiler. This saves fuel and can possibly result in the use of a smaller boiler.

### For compressor cooling

#### Alfa Laval offers:

#### Air cooling

- AlfaNova fusion-bonded plate heat exchangers
- Copper brazed plate heat exchangers
- Gasketed plate heat exchangers

#### Oil cooling

- Copper brazed plate heat exchangers
- Gasketed plate heat exchangers

#### Water cooling

- AlfaBlue air heat exchangers

#### Heat recovery

- Copper brazed plate heat exchangers
- Gasketed plate heat exchangers



# Gensets and cogeneration

## Combined heat and power applications from Alfa Laval

### The full benefits of energy efficiency

Cogeneration or combined heat and power application is a very effective and efficient form of power generation, allowing total energy utilization to reach 90%. This efficiency doesn't just happen by itself – it's the know-how behind it that produces such great results.

Alfa Laval offers a complete range of cooling solutions for both gensets and combined heat and power systems.

With an extensive focus on R&D, air heat exchangers (AHEs), gasketed plate heat exchangers (GPHEs) and brazed plate heat exchangers (BPHEs) have been developed to ensure lower emissions and substantial cost savings year after year due to their cost-effective, highly engineered designs.

Alfa Laval offers more than just products, we offer a partnership based

on our long experience, resources, and engineering proficiency.

Having delivered optimal heat transfer solutions for more than a century, Alfa Laval meets a wide range of needs and offers unparalleled expertise – ensuring future-proof solutions that can be relied on time and time again.

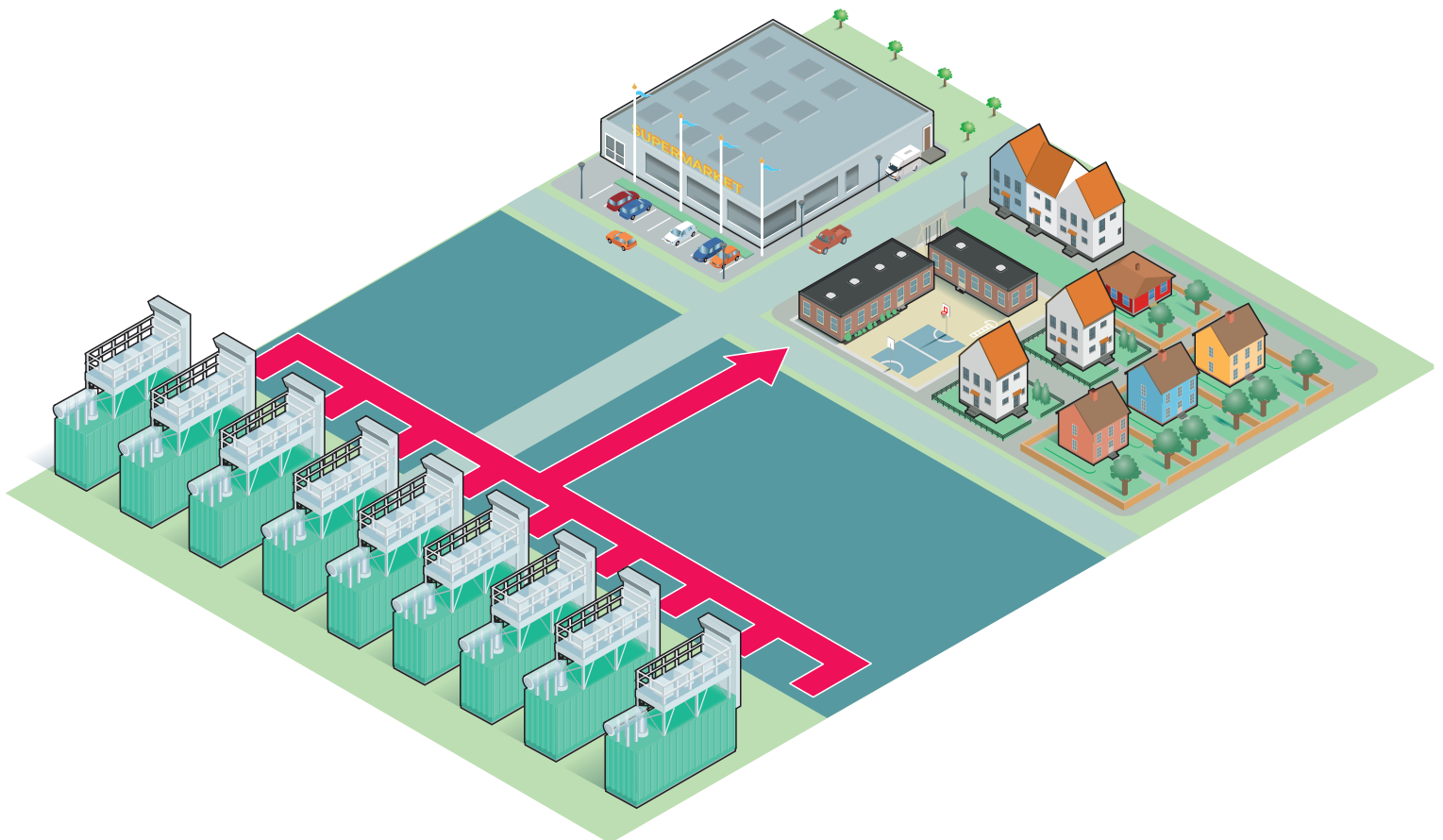



## Gensets

A generating set or genset is a system that generates electricity. The purpose of a genset is to provide back-up or redundancy electricity when the primary systems go offline. Thus, if the standard supply of electricity fails, then the genset will still fulfill the need and a blackout is avoided. Gensets are often used for critical social functions, such as industries, agriculture, water treatment plants, heating plants/district

heating systems, shopping centres and banks.

The genset system consists of an engine, fueled often by diesel or natural gas, which drives a generator. The generator then creates the electricity to be used by the site. When the engine is running it becomes heated and needs to be cooled. A typical engine will have two circuits, one high

temperature (HT) and one low temperature (LT) circuit, which need to be cooled to ensure the continued performance of the engine and, in turn, the genset. Alfa Laval's wide portfolio of air heat exchangers, AHE, can offer both combined and single circuit configurations in one compact unit, making the installation more compact.

### Working Principle Genset

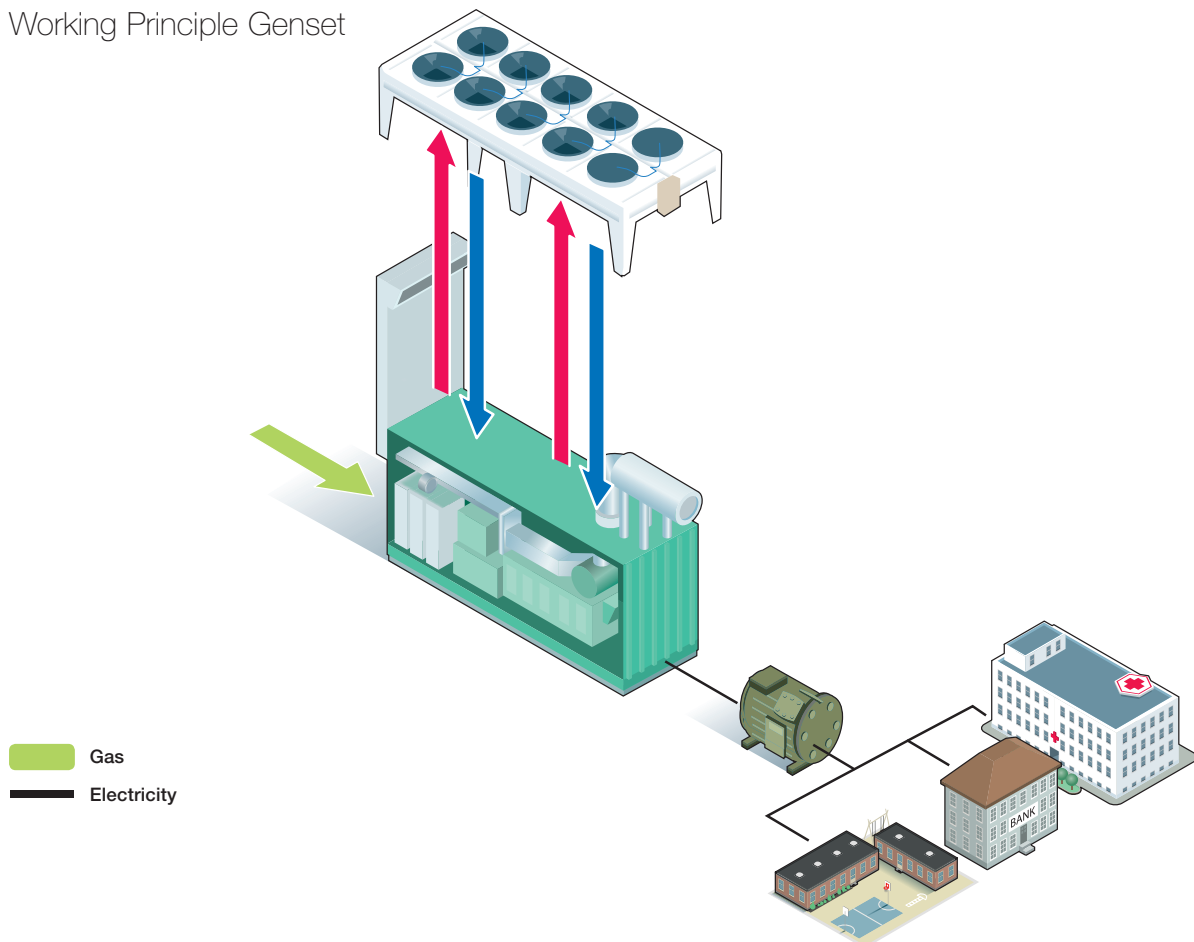



## Combined heat and power – natural gas/diesel

Combined heat and power systems, CHP, utilize the heat created when an engine is running. The heat can be recovered and used via Alfa Laval plate heat exchangers, PHE's. This type of system is used either as a primary source of energy or as a secondary source for critical social functions, such as hospitals, schools, hotels and retirement homes. The benefit of using it as a primary source is that the

installation is self-sufficient and full control of uptime and downtime is possible. When used as a secondary source of energy the benefits are the redundancy of the central energy grid and the security it provides against power shortages.

CHP's offer many benefits:

- More efficient utilization of input energy.

- Waste heat is a positive byproduct.
- Possible to sell surplus electricity and heat back to the grid.
- Low emissions and environmentally friendly (especially with natural gas).
- Efficiencies in biogas production help cogeneration development from an agricultural perspective.
- Possibility of government subsidies.
- Payback time 3-5 years, depending on system set-up

### Regular power generation

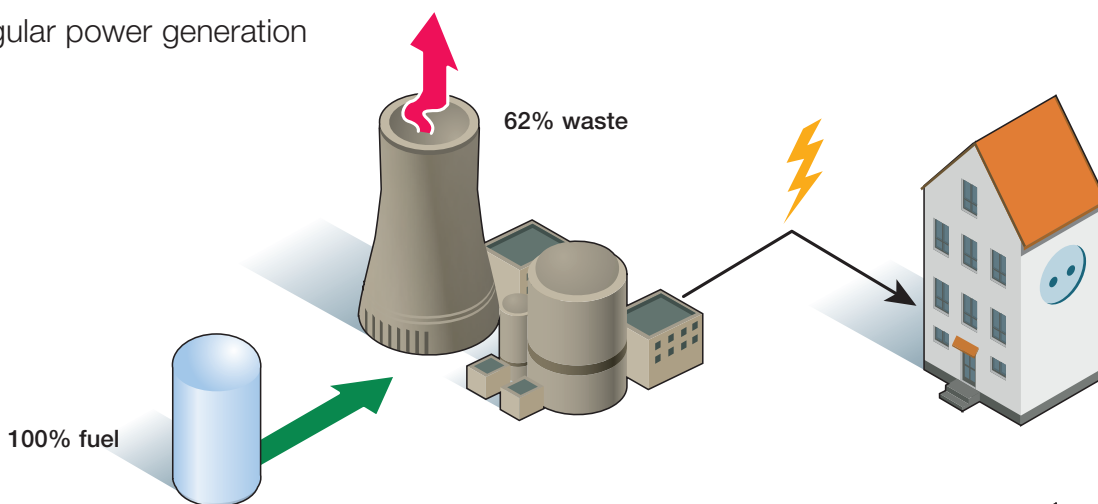

### Cogeneration plant

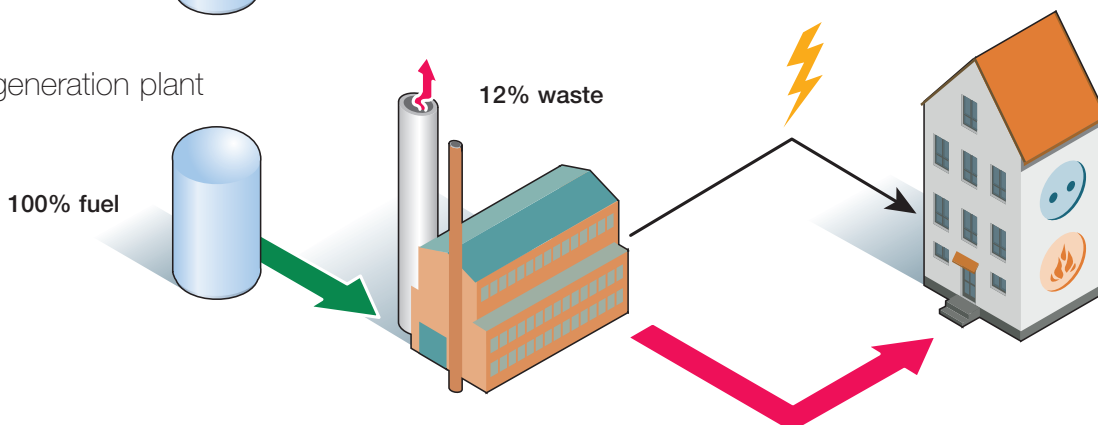





## Working principle

The concept of CHP is built on “simultaneous generation of two useful forms of energy, electricity and heat, from the same plant using one single primary energy source”.

An engine generates heat from the lube oil, low temperature circuit and from

the jacket water, high temperature circuit. If these circuits are connected to Alfa Laval plate heat exchangers, PHE’s, the heat can be recovered and used. This is done by having the secondary sides connected to separate water circuits from which you can extract the heat for any purpose,

typically tap water or an indoor heating system. When the engine is producing more heat than is needed, the heat stored in the secondary circuits needs to be dissipated. This is preferably handled by an Alfa Laval air heat exchanger, AHE, also called a dry cooler.

### Working principle combined heat and power system

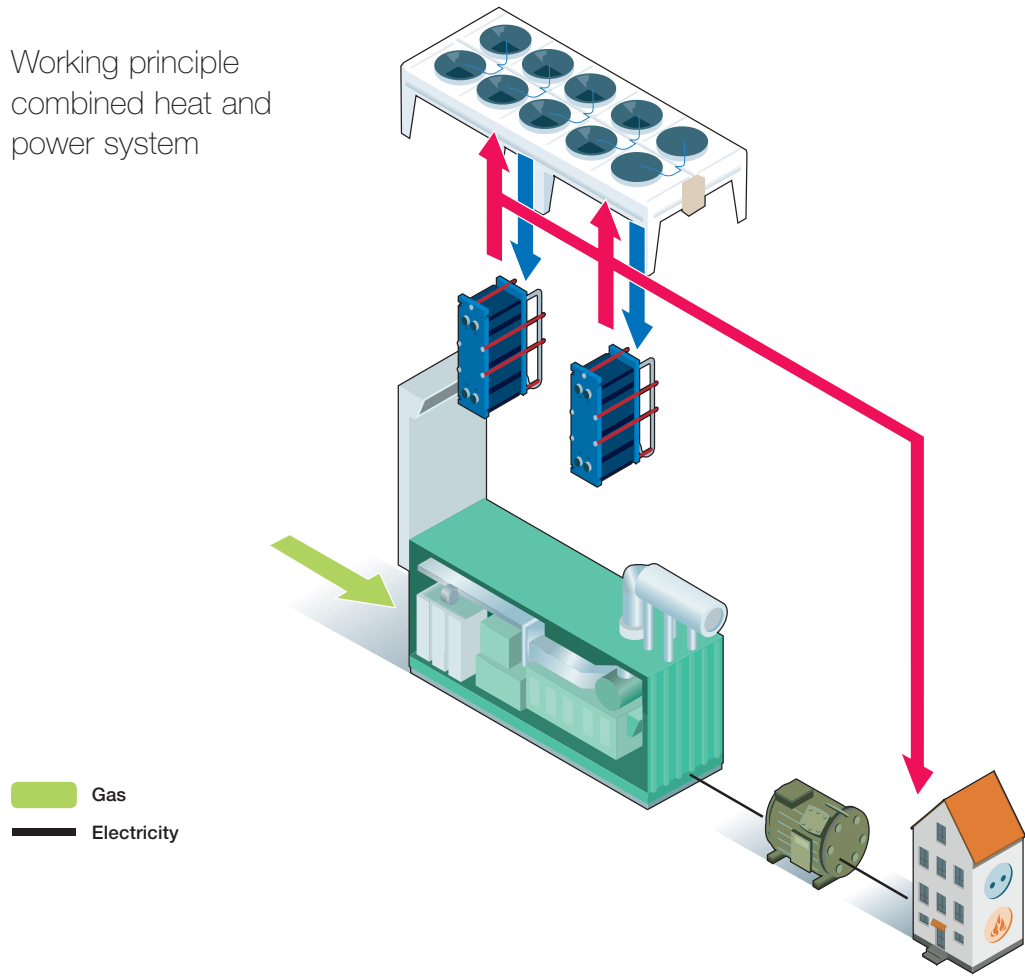

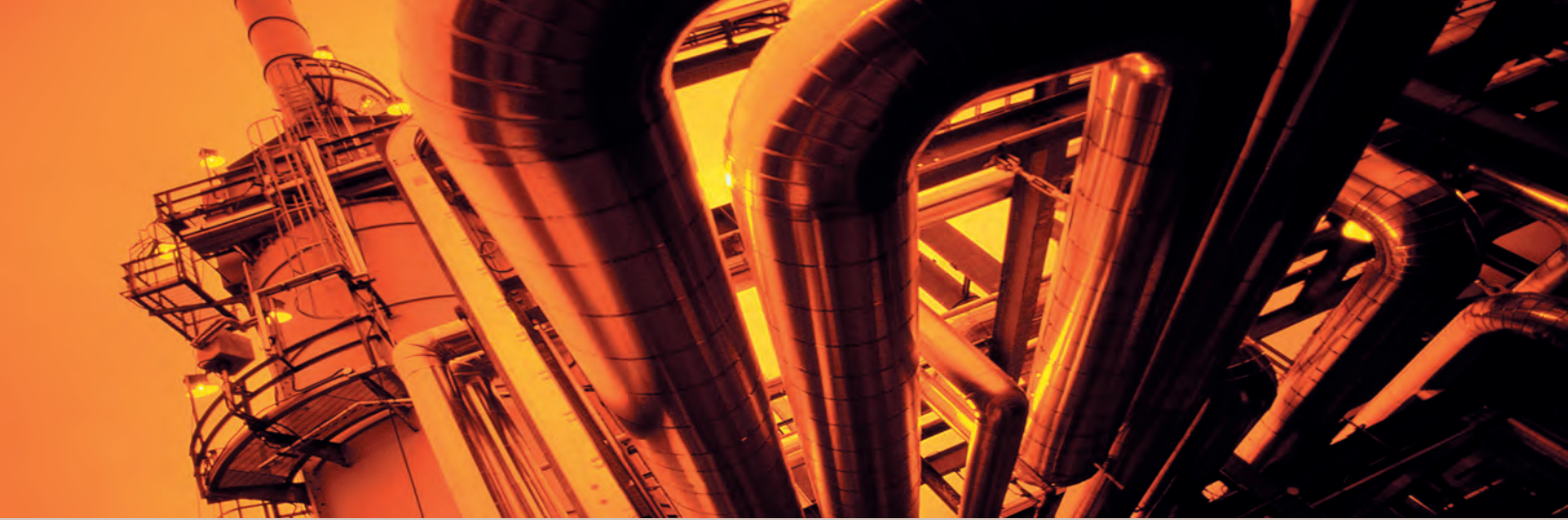

## Combined heat and power – biogas

For areas or sites that produce their own biowaste, there is a profitable opportunity to convert this into biogas that can be used to fuel a combined heat and power system. Thus, sites such as farms, wastewater treatment plants (wwtp), landfill waste and mines, can be self-sufficient in terms of energy

and create their own independent, sustainable energy cycle, where all energy consumed is also created via their own waste.

Since it is only the engine fuel that is different, the working principle of the biogas CHP is the same as the CHP

system fueled by natural gas or diesel, as described in an earlier section.

Alfa Laval's extensive portfolio includes PHE's suitable for heat recovery in the LT and HT circuits, and AHE's for dissipating excessive heat.

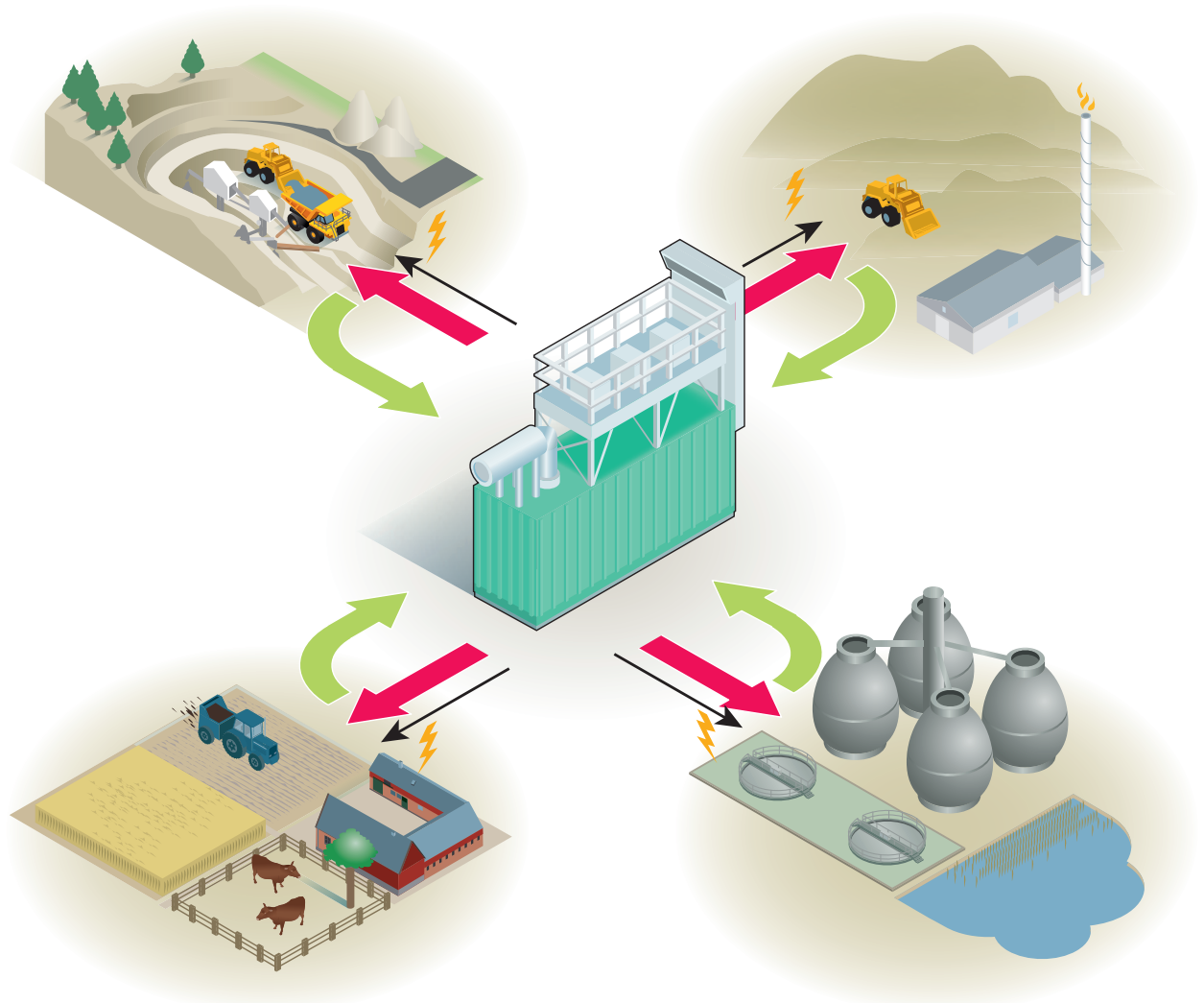





## Organic Rankine Cycle (ORC)

The Organic Rankine Cycle (ORC) is named for its use of an organic, high molecular mass fluid with a liquid-vapor phase change, or boiling point, occurring at a lower temperature than the water-steam phase change. The fluid allows Rankine cycle heat recovery from lower temperature sources such as biomass combustion, industrial waste heat, geothermal heat, solar ponds, etc. The low-temperature heat is converted into useful work, that can itself be converted into electricity.

The working principle of the organic Rankine cycle is that the working fluid is pumped to a boiler where it is evaporated, passes through a turbine and is finally re-condensed. The system is fuelled by adding energy into the evaporator at high temperatures and useful energy is extracted from the turbine/expander, as electricity, and from the condenser, as hot water/heat. To improve the efficiency of the system a regenerator can be added into the cycle.

Typical usage areas for an ORC system are different types of power sources, such as biomass power, geothermal plants, solar thermal power and waste heat to power systems. All these types of system are considered renewable and environmentally sound.

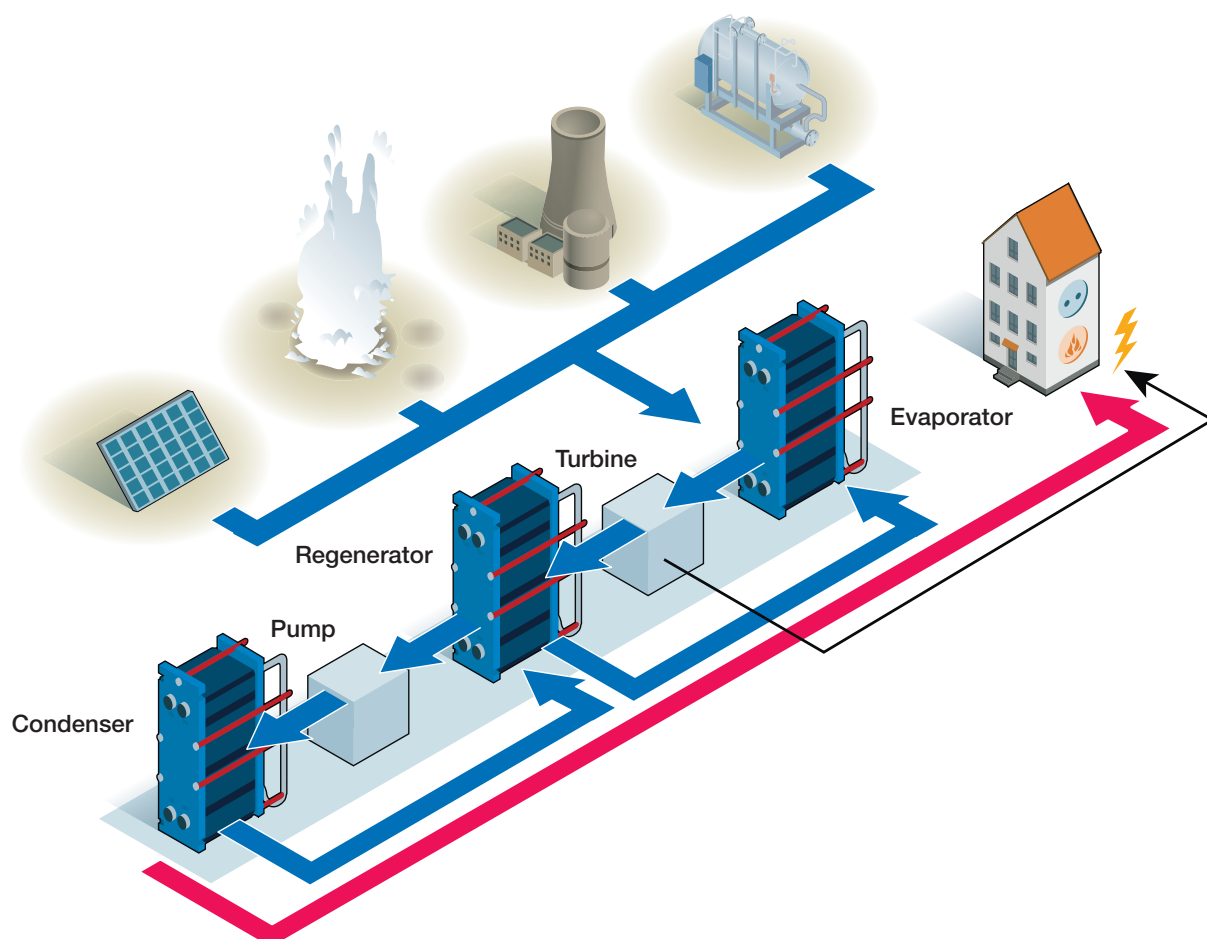

# Power converter cooling

Power converters are present all along the electricity distribution network and in basically all types of process and manufacturing industries. A power converter is an electrical or electro-mechanical device for converting electrical energy. It is used to increase or decrease voltage (transformer), convert alternating current to direct current (rectifier) or to control and convert alternating current frequency (frequency converter).

Conversions of electrical energy generate heat and hence the converters need to be cooled.

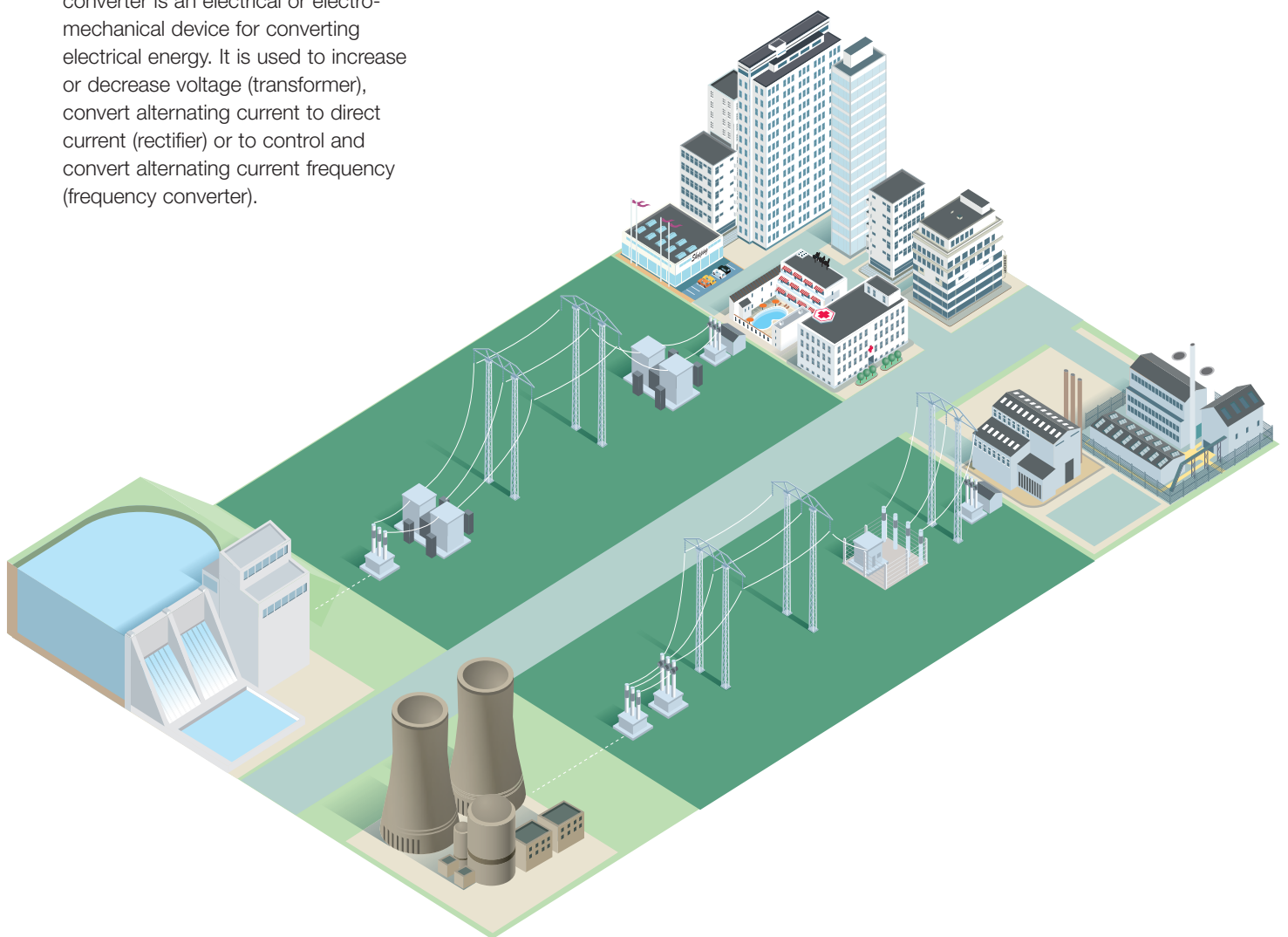



## Transformer cooling

A transformer is a static electrical device that transfers energy by inductive coupling between its winding circuits. A varying current in the primary winding creates a varying magnetic flux in the transformer's ferromagnetic core and thus a varying magnetic flux through the secondary winding. This varying magnetic flux induces a varying electromotive force, or voltage, in the secondary winding.

Transformers range in size from thumbnail-sized units hidden in micro-phones to units weighing hundreds of tons used in the power grid. They are essential for the transmission, distribution, and utilization of electric power.

The transformer core and windings are insulated in transformer oil, a highly refined, low-viscosity mineral oil, which is stable at high temperatures. The

purpose of this oil is to insulate and cool the transformer core and windings.

The oil is cooled either by natural convection or by forced air or water. The cooling abbreviations OFAF (Oil Forced Air Forced) or OFWF (Oil Forced Water Forced) in particular indicate a need for heat exchangers. By maintaining the oil at a low temperature, a higher electro load is allowed in the transformer on a constant basis or during periods of peak demand.

Intermixing of oil and water can be devastating for the transformer. For that reason, double-wall heat exchangers are used as a safety precaution in OFWF-cooling.

Alfa Laval offers a complete range of high-quality solutions for cooling transformer oil by forced air (OFAF) or



by forced water (OFWF). The offering includes:

- Air heat exchangers – AlfaBlue transformer oil coolers
- Gasketed plate heat exchangers – double wall.

Alfa Laval can also supply efficient, maintenance-free transformer oil pumps.

A rectifier converts alternating current

### Transformer cooling with air

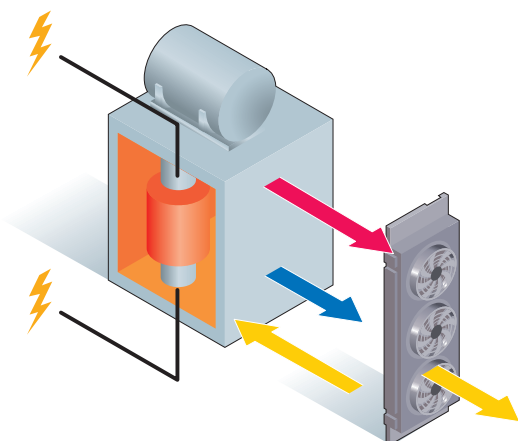

### Transformer cooling with water

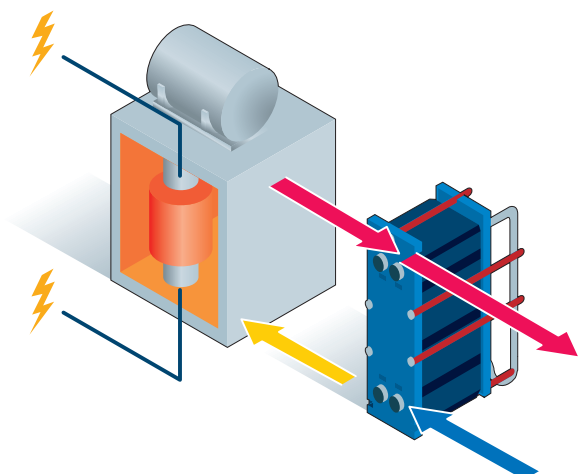





## Rectifier cooling

A rectifier converts alternating current (AC) to direct current (DC). The vital part in a rectifier is a thyristor valve or diode. A thyristor valve or diode is a semiconducting device which in operation releases heat and needs to be cooled. Compact rectifiers are normally cooled directly by air while medium and high current rectifiers are more commonly cooled by deionized water. Especially on HVDC (High Voltage Direct Current) thyristor valves, deionized water has replaced pressurized air and oil due to its high cooling efficiency and insulation characteristics. Apart from cooling the thyristor or the diode the deionized water can also cool fuses and other components in a rectifier module.

Because of the deionized water, material selection in the heat exchanger is vital. Stainless steel is standard. Rectifiers can also be combined with transformers with the whole unit cooled by two separate cooling circuits.

Rectifiers are to be found in a wide range of applications within different industries. Some examples are HVDC transmission stations, surface treatment and process lines in the steel industry, the chemical industry, metallurgical industry and various electrolysis processes.

Air cooled rectifier

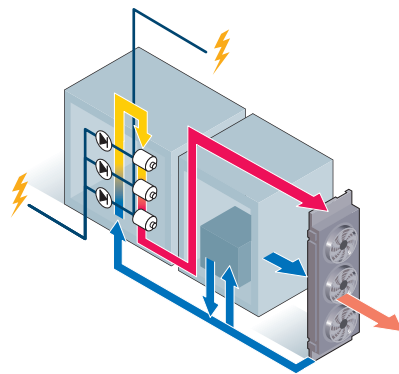

Water cooled rectifier

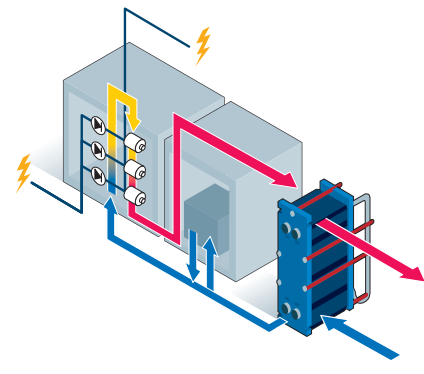

### For rectifier cooling

#### Alfa Laval offers:

- AlfaBlue and AlfaBlue Power air heat exchangers
- Gasketed plate heat exchangers
- AlfaNova fusion-bonded plate heat exchangers.

The compact fusion-bonded heat exchanger in 100% stainless steel is particularly well suited for pure water when space is limited.

Rectifier transformer, water cooled

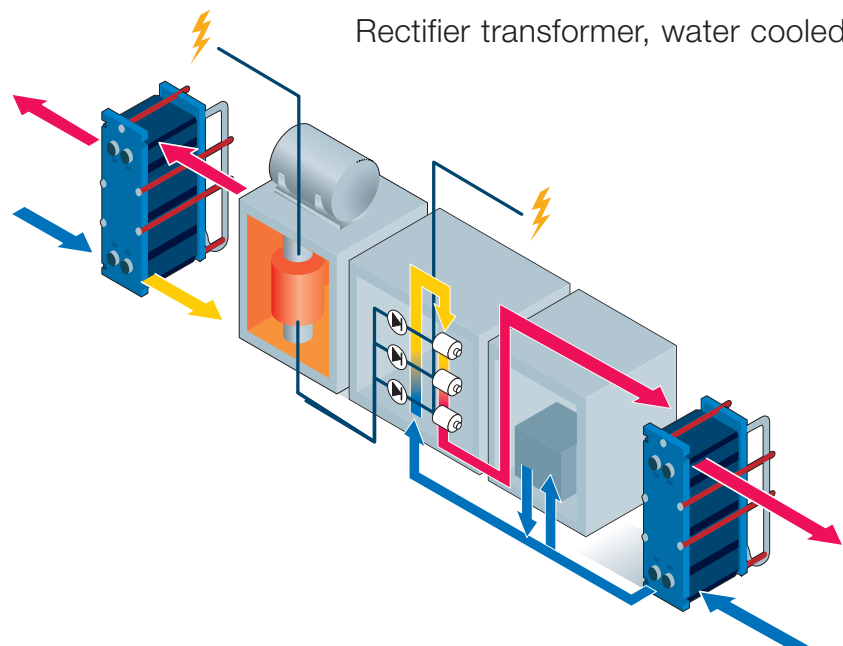





## Frequency converter cooling (AC drives)

An electrical drive or AC drive is a system for controlling the rotational speed of an alternating current (AC) electric motor by controlling the frequency of the electrical power supplied to the motor. AC drives are also known by various other names such as adjustable speed drives (ASD), adjustable frequency drives (AFD), variable frequency drives (VFD), variable speed drives (VSD) and frequency converters (FC).

AC drives are widely used in e.g., speed control and soft starting of fans, pumps, blowers, compressors, rolling

mills, extruders, marine propulsion systems and wind power generators.

Applying an electrical drive to an electrical motor offers major energy saving potential. Small drive systems are mostly air cooled while larger drives are increasingly liquid cooled. The cooling medium used is deionized water or, on older drive systems, tap water.

When using direct air cooling on a drive system the heat dissipates into the surrounding air. Liquid cooling offers a major benefit – the heat will be

dissipated in the water and the heat loss to the surroundings will be practically eliminated.

### For drives cooling Alfa Laval offers:

- Gasketed plate heat exchangers
- AlfaNova fusion-bonded plate heat exchangers
- Copper brazed plate heat exchangers.

The compact fusion-bonded Alfa Nova in 100% stainless steel is particularly well suited for pure water when space is limited.

### Drives cooling

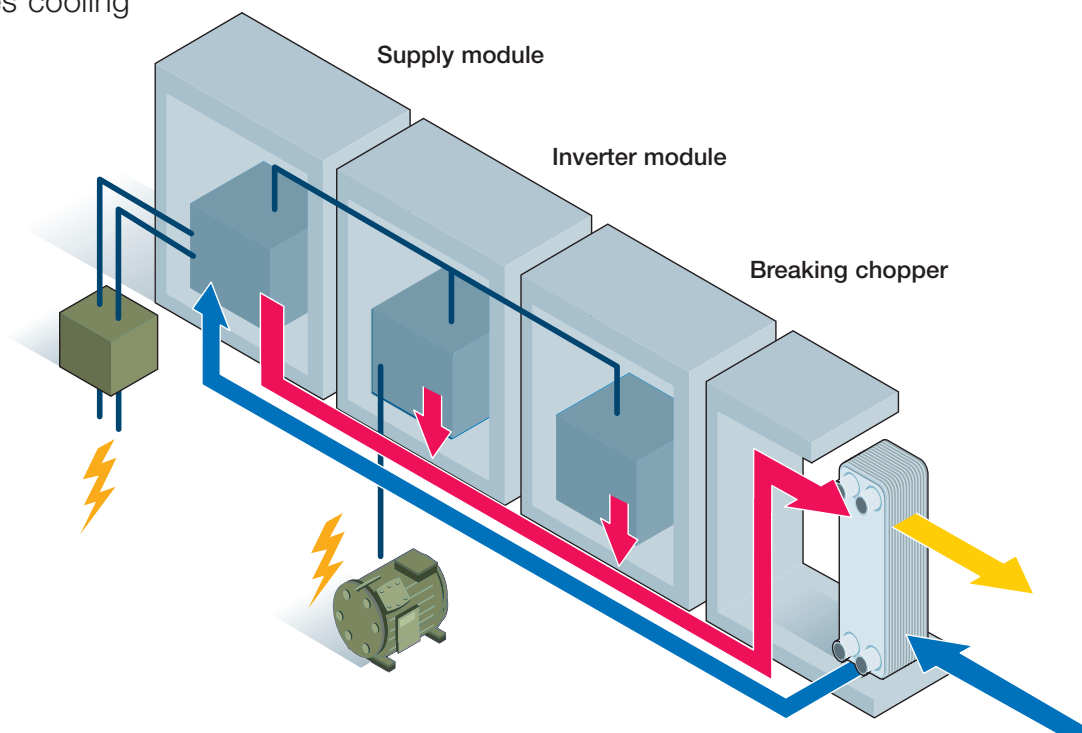



# Chapter 4

1. The Alfa Laval Group
2. Heating and cooling solutions from Alfa Laval
3. Applications
- 4. The theory behind heat transfer**
5. Product range
6. Gasketed plate heat exchangers
7. Brazed plate heat exchangers
8. Fusion-bonded plate heat exchangers, AlfaNova
9. Air heat exchangers
10. All-welded heat exchangers
11. Filters





# The theory behind heat transfer

The following pages will help you gain a better understanding of how heat exchangers work.

The basic principles of heat transfer will be clearly and simply illustrated.

The natural laws of physics always allow the driving energy in a system to flow until equilibrium is reached. Heat leaves the warmer body or the hottest fluid, as long as there is a temperature difference, and will be transferred to the cold medium.

A heat exchanger follows this principle in its endeavour to reach equalization. With a plate type heat exchanger, the heat penetrates the surface, which separates the hot medium from the cold one very easily. It is therefore possible to heat or cool fluids or gases which have minimal energy levels.

The difference in temperature is the heat exchanger's "driving energy".



# Heat transfer theory

The theory of heat transfer from one media to another, or from one fluid to another, is determined by several basic rules.

- Heat will always be transferred from a hot medium to a cold medium.
- There must always be a temperature difference between the media.
- The heat lost by the hot medium is equal to the amount of heat gained by the cold medium, except for losses to the surroundings.

## Heat exchangers

A heat exchanger is a piece of equipment that continually transfers heat from one medium to another.

There are two main types of heat exchangers.

- Direct heat exchanger, where both media are in direct contact with each other. It is taken for granted that the media are not mixed together.

An example of this type of heat exchanger is a cooling tower, where water is cooled through direct contact with air.

- Indirect heat exchanger, where the two media are separated by a wall through which heat is transferred.

## Heat transfer theory

Heat can be transferred by three methods.

- **Radiation** – Energy is transferred by electromagnetic radiation. One example is the heating of the earth by the sun.
- **Conduction** – Energy is transferred between solids or stationary fluids by the movement of atoms or molecules.
- **Convection** – Energy is transferred by mixing part of a medium with another part.

a) Natural convection, where the movement of the media depends entirely upon density difference, and temperature differences are evened out.

b) Forced convection, where the movement of the media depends entirely or partly upon the results of an outside influence. One example of this is a pump causing movement in a fluid.

## Heat exchanger types

In this context only indirect heat exchangers are discussed, i.e. those where the media are not mixed, but where the heat is transferred through heat-transfer surfaces.

Temperature losses through radiation can be disregarded when considering heat exchangers in this context. Indirect heat exchangers are available in several main types (plate, shell-and-tube, spiral etc.) In most cases the

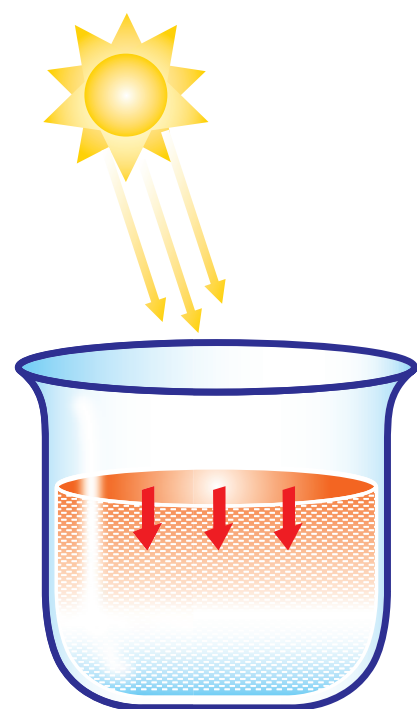

Radiation

plate type is the most efficient heat exchanger. Generally it offers the best solution to thermal problems, giving the widest pressure and temperature limits within the constraint of current equipment. The most notable advantages of a plate heat exchanger are:

- Takes up much less space than a traditional shell-and-tube heat exchanger.
- Thin material for the heat transfer surface – this gives optimum heat transfer, since the heat only has to penetrate thin material.
- High turbulence in the medium – this gives a higher convection, which results in efficient heat transfer between the media. The consequence

of this higher heat transfer coefficient per unit area is not only a smaller surface area requirement but also a more efficient operation.

The high turbulence also gives a self-cleaning effect. Therefore, when compared to the traditional shell-and-tube heat exchanger, the fouling of the heat transfer surfaces is considerably reduced. This means that the plate heat exchanger can remain in service far longer between cleaning intervals.

- Flexibility – the plate heat exchanger consists of a framework containing several heat transfer plates. It can easily be extended to increase capacity. Furthermore, it is easy to open for the purpose of cleaning. (This only applies to gasketed heat exchangers, and not to brazed or fusion-bonded units.)

- Variable thermal length – most of the plate heat exchangers manufactured by Alfa Laval are available with two different pressing patterns. When the plate has a narrow pattern, the pressure drop is higher and the heat exchanger is more effective. This type of heat exchanger has a long thermal channel.

When the plate has a wide pattern, the pressure drop is smaller and the heat transfer coefficient is accordingly somewhat smaller. This type of heat exchanger has a short thermal channel.

When two plates of different pressing patterns are placed next to each other, the result is a compromise between long and short channels as well as between pressure drop and effectiveness.

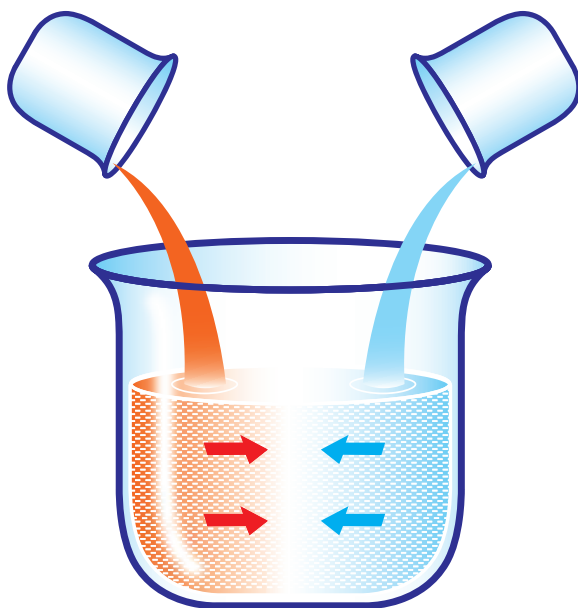

Convection

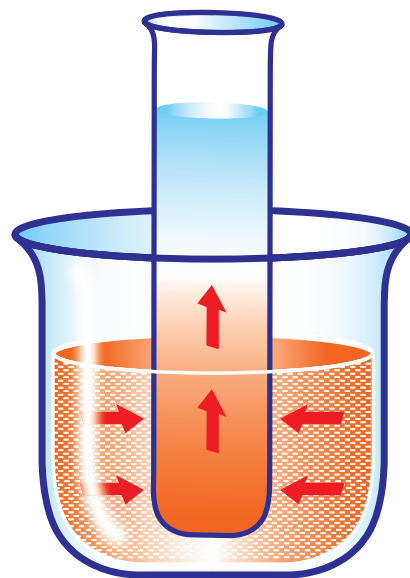

Conduction

# Calculation method



To solve a thermal problem, we must know several parameters. Further data can then be determined. The six most important parameters are the following:

- The amount of heat to be transferred (heat load).
- The inlet and outlet temperatures on the primary and secondary sides.
- The maximum allowable pressure drop on the primary and secondary sides.
- The maximum operating temperature.
- The maximum operating pressure.
- The flow rate on the primary and secondary sides.

If the flow rate, specific heat and temperature difference on one side are known, the heat load can be calculated. See also page 4:6.

## Temperature program

This means the inlet and outlet temperatures of both media in the heat exchanger.

- T1 = Inlet temperature – hot side
- T2 = Outlet temperature – hot side
- T3 = Inlet temperature – cold side
- T4 = Outlet temperature – cold side

The temperature program is shown in the diagram below.

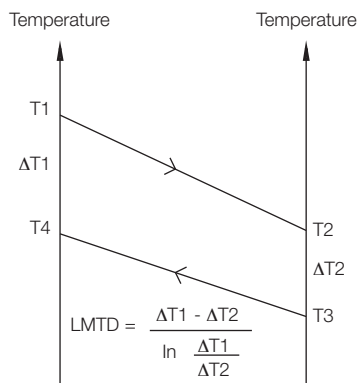

## Heat load

Disregarding heat losses to the atmosphere, which are negligible, the heat lost (heat load) by one side of a plate heat exchanger is equal to the heat gained by the other. The heat load (P) is expressed in kW or kcal/h.

## Logarithmic mean temperature difference

Logarithmic mean temperature difference (LMTD) is the effective driving force in the heat exchanger. See diagram to the left.

## Thermal length

Thermal length ( $\Theta$ ) is the relationship between temperature difference  $\delta t$  on one side and LMTD.

$$\Theta = \frac{\delta t}{\text{LMTD}}$$

Thermal length describes how difficult a duty is from a thermal perspective.

## Density

Density ( $\rho$ ) is the mass per unit volume and is expressed in  $\text{kg/m}^3$  or  $\text{kg/dm}^3$ .



$$P = m \times c_p \times \delta t$$

Where;

$P$  = Heat load (kW)

$m$  = Mass flow (kg/s)

$c_p$  = Specific heat (KJ/kg °C)

$\delta t$  = Difference between inlet and outlet temperatures on one side (°C)

### Cooling

For some duties, cooling applications for example, the temperature program is very tight with close approaches on the different temperatures. This gives what we refer to as high theta duties and requires high theta units. High theta duties are duties that have  $\Theta > 1$  and are characterized by:

- Long plate, longer time for the fluid to be cooled
- Low pressing depth that gives less fluid per plate to be cooled

Plate heat exchangers are superior compared to shell-and-tube heat exchangers when it comes to theta values. Shell-and-tube heat exchangers can go up to a maximum value of theta ~1 while plate heat exchangers reach theta values of 10 and more. For a shell-and-tube to climb over theta value of 1 or more, several units need to be installed in a series.

### Flow rate

This can be expressed in two different terms, either by weight or by volume. The units of flow by weight are in kg/s or kg/h, the units of flow by volume in m<sup>3</sup>/h or l/min. To convert units of volume into units of weight, it is necessary to multiply the volume flow by the density.

The maximum flow rate usually determines which type of heat exchanger is the appropriate one for a specific purpose. Alfa Laval plate heat exchangers can be used for flow rates from 0.05 kg/s to 1,400 kg/s. In terms of volume, this equates 0.18 m<sup>3</sup>/h to 5,000 m<sup>3</sup>/h in a water application. If the flow rate is in excess of this, please consult your local Alfa Laval representative.

### Pressure drop

Pressure drop ( $\Delta p$ ) is in direct relationship to the size of the plate heat exchanger. If it is possible to increase the allowable pressure drop, and incidentally accept higher pumping costs, then the heat exchanger will be smaller and less expensive. As a guide, allowable pressure drops between 20 and

100 kPa are accepted as normal for water/water duties.

### Specific heat

Specific heat ( $c_p$ ) is the amount of energy required to raise 1 kg of a substance by one degree centigrade. The specific heat of water at 20°C is 4.182 kJ/kg °C or 1.0 kcal/kg °C.

### Viscosity

Viscosity is a measure of the ease of flow of a liquid. The lower the viscosity, the more easily it flows.

Viscosity is expressed in centiPoise (cP) or centiStoke (cSt).

### Overall heat transfer coefficient

Overall heat transfer coefficient ( $k$ ) is a measure of the resistance to heat flow, made up of the resistances caused by the plate material, amount of fouling, nature of the fluids and type of exchanger used.

Overall heat transfer coefficient is expressed as W/m<sup>2</sup> °C or kcal/h, m<sup>2</sup> °C.

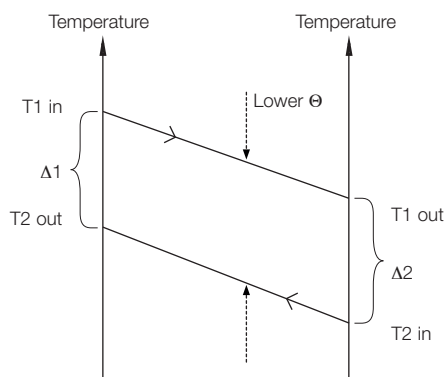

The diagram shows that large temperature differences result in low theta.

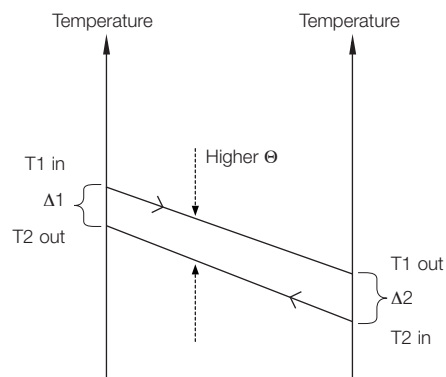

The diagram shows that small temperature differences result in high theta.

## Calculation method

The heat load of a heat exchanger can be derived from the following two formulas:

### 1. Heat load, Theta and LMTD calculation

$$P = m \cdot c_p \cdot \delta t \quad \left( m = \frac{P}{c_p \cdot \delta t} ; \delta t = \frac{P}{m \cdot c_p} \right)$$

$$P = k \cdot A \cdot \text{LMTD}$$

Where:

P = heat load (kW)

m = mass flow rate (kg/s)

$c_p$  = specific heat (kJ/kg °C)

$\delta t$  = temperature difference between inlet and outlet on one side (°C)

k = heat transfer coefficient (W/m<sup>2</sup> °C)

A = heat transfer area (m<sup>2</sup>)

LMTD = log mean temperature difference

$$\Theta = \text{Theta-value} = \frac{\delta t}{\text{LMTD}} = \frac{k \cdot A}{m \cdot c_p}$$

T1 = Temperature inlet – hot side

T2 = Temperature outlet – hot side

T3 = Temperature inlet – cold side

T4 = Temperature outlet – cold side

LMTD can be calculated by using the following formula, where  $\Delta T1 = T1 - T4$  and  $\Delta T2 = T2 - T3$

$$\text{LMTD} = \frac{\Delta T1 - \Delta T2}{\ln \frac{\Delta T1}{\Delta T2}}$$

### 2. Heat transfer coefficient and design margin

The total overall heat transfer coefficient k is defined as:

$$\text{Where: } \frac{1}{k} = \frac{1}{\alpha_1} + \frac{1}{\alpha_2} + \frac{\delta}{\lambda} + R_f = \frac{1}{k_c} + R_f$$

$$\text{The design margin (M) is calculated as: } M = \frac{k_c - k}{k}$$

$\alpha_1$  = The heat transfer coefficient between the warm medium and the heat transfer surface (W/m<sup>2</sup> °C)

$\alpha_2$  = The heat transfer coefficient between the heat transfer surface and the cold medium (W/m<sup>2</sup> °C)

$\delta$  = The thickness of the heat transfer surface (m)

$R_f$  = The fouling factor (m<sup>2</sup> °C/W)

$\lambda$  = The thermal conductivity of the material separating the medias (W/m °C)

$k_c$  = Clean heat transfer coefficient ( $R_f=0$ ) (W/m<sup>2</sup> °C)

k = Design heat transfer coefficient (W/m<sup>2</sup> °C)

M = Design Margin (%)

Combination of these two formulas gives:  $M = k_c \cdot R_f$

i.e the higher  $k_c$  value, the lower  $R_f$ -value to achieve the same design margin.

$$\text{LMTD} = \frac{\Delta T_1 - \Delta T_2}{\ln \frac{\Delta T_1}{\Delta T_2}}$$

$$\frac{1}{k} = \frac{1}{\alpha_1} + \frac{1}{\alpha_2} + \frac{\delta}{\lambda} + R_f = \frac{1}{k_c} + R_f$$

Every parameter in the equation above can influence the choice of heat exchanger. The choice of materials does not normally influence the efficiency, only the strength and corrosion properties of the unit.

In a plate heat exchanger, we have the advantages of small temperature differences and plate thicknesses of between 0.3 and 0.6 mm. The alpha values are products of the very high turbulence, and the fouling factor is usually very small. This gives a k-value which under favourable circumstances can be in the order of 8,000 W/m<sup>2</sup> °C.

With traditional shell-and-tube heat exchangers, the k-value will be below 2,500 W/m<sup>2</sup> °C.

Important factors to minimize the heat exchanger cost:

1. Pressure drop

The larger allowed pressure drop, the smaller the heat exchanger.

2. LMTD

The larger the temperature difference between the media, the smaller the heat exchanger.

**Manufacturing materials**

High-quality AISI 316 stainless steel plates are used in most Alfa Laval heat exchangers for water/water applications. When the chloride content does not require AISI 316, the less expensive stainless steel material AISI 304 may sometimes be used. Several other plate materials are also available for various applications. For Alfa Laval brazed and fusion bonded plate heat exchangers AISI 316 is always used. For salt and brackish water only titanium should be used.

**Pressure and temperature limitations**

The maximum allowed temperature and pressure influence the cost of the heat exchanger. As a general rule, the lower the maximum temperature and maximum pressure are, the lower the cost of the heat exchanger will be.

**Fouling and fouling factors**

Fouling allowance can be expressed either as a design margin (M), i.e. an additional percentage of heat transfer area, or as a fouling factor (R<sub>f</sub>) expressed in the units m<sup>2</sup> °C/W or m<sup>2</sup>h °C/kcal. R<sub>f</sub> should be much lower for a plate heat exchanger than for a shell-and-tube exchanger. There are two main reasons for this.

**Higher k-values means lower fouling factors**

The design of plate heat exchangers gives much higher turbulence, and thereby thermal efficiency, than a shell-and-tube exchanger. A typical k-value (water/water) for a plate heat exchanger is 6,000-7,500 W/m<sup>2</sup> °C while a typical shell-and-tube exchanger only gives 2,000-2,500 W/m<sup>2</sup> °C. A typical R<sub>f</sub>-value used for shell-and-tube exchangers is 1 x 10<sup>-4</sup> m<sup>2</sup> °C/W. With k-values 2,000-2,500 W/m<sup>2</sup> °C this give a Margin of 20-25%. (M = k<sub>c</sub> x R<sub>f</sub>). To achieve M = 20-25% in the plate heat exchanger with 6,000-7,500 W/m<sup>2</sup> °C the R<sub>f</sub>-value should only be 0.33 x 10<sup>-4</sup> m<sup>2</sup> °C/W.

**Difference in how margin is added**

In a shell-and-tube heat exchanger margin is often added by increasing the tube length, keeping the same flow through each tube. In a plate heat exchanger however, margin is added by adding parallel channels, i.e. lowering the flow per channel. This results in lower turbulence/efficiency, increasing the risk for fouling. A too high fouling factor can result in increased fouling!

For a plate heat exchanger in a water/water duty a Margin of 0-15% depending on water quality is normally enough.





# Chapter 5

1. The Alfa Laval Group
2. Heating and cooling solutions from Alfa Laval
3. Applications
4. The theory behind heat transfer
- 5. Product range**
6. Gasketed plate heat exchangers
7. Brazed plate heat exchangers
8. Fusion-bonded plate heat exchangers, AlfaNova
9. Air heat exchangers
10. All-welded heat exchangers
11. Filters



# Product range

Alfa Laval has a full range of heat exchangers, heat exchanger systems and accessories catering to every need, however large or small.

Alfa Laval is your assurance of quality in terms of compactness, ease of installation, low maintenance costs, high energy efficiency, confidence and flexibility.

In other words, reliable operation, unsurpassed operating life span and fast return on investment.





# Alfa Laval product range

Gasketed Plate Heat Exchangers	Brazed Plate Heat Exchangers	Fusion-bonded plate heat exchangers, AlfaNova
Read all about it in chapter 6	Read all about it in chapter 7	Read all about it in chapter 8
		
Air Heat Exchangers	All Welded Heat Exchangers	Filters
Read all about it in chapter 9	Read all about it in chapter 10	Read all about it in chapter 11
		



# Chapter 6

1. The Alfa Laval Group
2. Heating and cooling solutions from Alfa Laval
3. Applications
4. The theory behind heat transfer
5. Product range
- 6. Gasketed plate heat exchangers**
7. Brazed plate heat exchangers
8. Fusion-bonded plate heat exchangers, AlfaNova
9. Air heat exchangers
10. All-welded heat exchangers
11. Filters



# Gasketed plate heat exchangers

Alfa Laval gasketed plate heat exchangers are the most cost-effective solution available for industry applications.

Our gasketed plate heat exchanger range is the result of decades of experience, research and development in heat transfer technology. By combining innovative design with high quality we guarantee maximum performance with minimum operating costs.

At a quick glance the design may seem traditional, but when studying the plates, gaskets and frames in detail the superiority of Alfa Laval gasketed plate heat exchangers becomes obvious. Attention to detail is what gives Alfa Laval the winning edge.

Our products and our sales and service organization make Alfa Laval the ideal business partner, as well as the unquestioned world market leader.

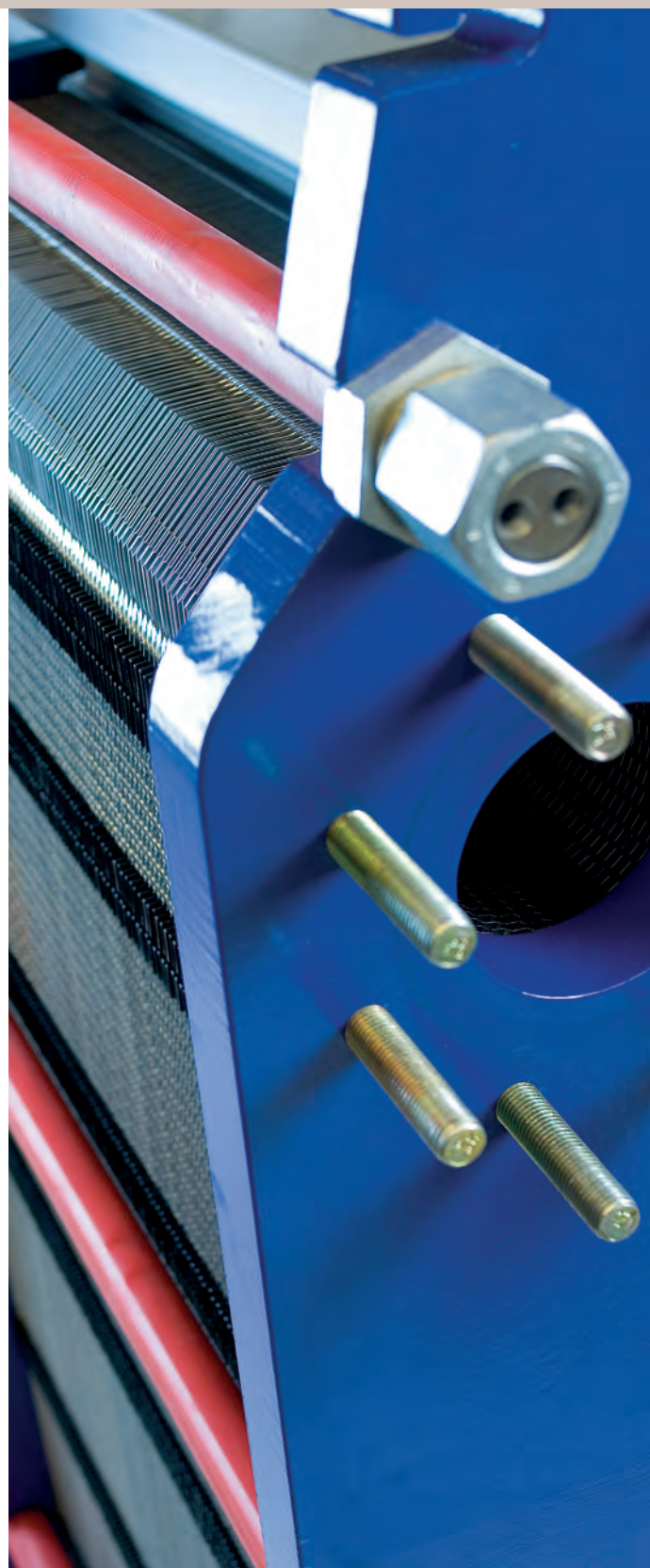

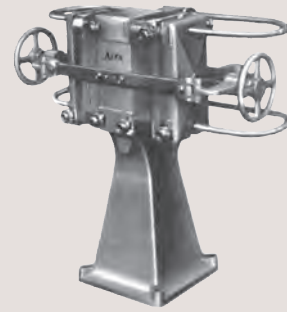

Alfa Laval supplied the first plate heat exchangers to the dairy industry in 1931. Plates were 5-10 mm thick with a milled pattern, compared to 0.4 mm today. In developing our range of plate heat exchangers, we have focused on cost-efficiency.

## Reasons to buy gasketed plate heat exchangers from the market leader

Alfa Laval's gasketed plate heat exchangers are designed to meet the highest expectations when it comes to energy efficiency, compactness and reliable performance.

### **High energy efficiency**

With innovative plate design, we provide superior flow distribution across the entire plate surface. This results in excellent heat transfer and high energy efficiency thanks to the elimination of stagnant zones and reduced risk of fouling.

### **Compact size**

The compact design of our gasketed plate heat exchangers makes it easy to fit compact spaces. They come equipped with all features needed for easy installation and quick start-up.

### **Reliable performance over time**

Depending on fluid types, pressures and temperatures, Alfa Laval gasketed plate heat exchangers are tailored to meet highest expectations on performance and lifetime. Alfa Laval gasketed plate heat exchangers are also available as AHRI performance certified versions called Alfa Laval AQ-series. The performance certification is according to AHRI Standard 400 and is verified in the AHRI Liquid to Liquid Heat Exchanger certification program, LLHE.

### **Easy and safe maintenance**

Our gaskets and plate pack alignment design provides easy and cost effective maintenance. The frame is equipped with features that support the unit and secure safe opening and closing during service.





Alfa Laval gasketed plate heat exchangers provide heating and cooling for Federation Complex Towers, Moscow, Russia.



## Insights

You need to put quality and reliability in an economic context. It's about how to make processes more efficient, while saving energy. About how optimized performance gives customers the best operating economy. And about how to minimize impact on the environment and climate change.

Above all it is tackling the need to build long life into equipment to minimize total cost of ownership and maximize profitability. Why governs how.

These are the insights Alfa Laval is using to build gasketed plate heat exchangers. Take a closer look behind the surface. There's more to see than what meets the eye – actually there's a whole story to tell.

# Energy efficiency at its peak

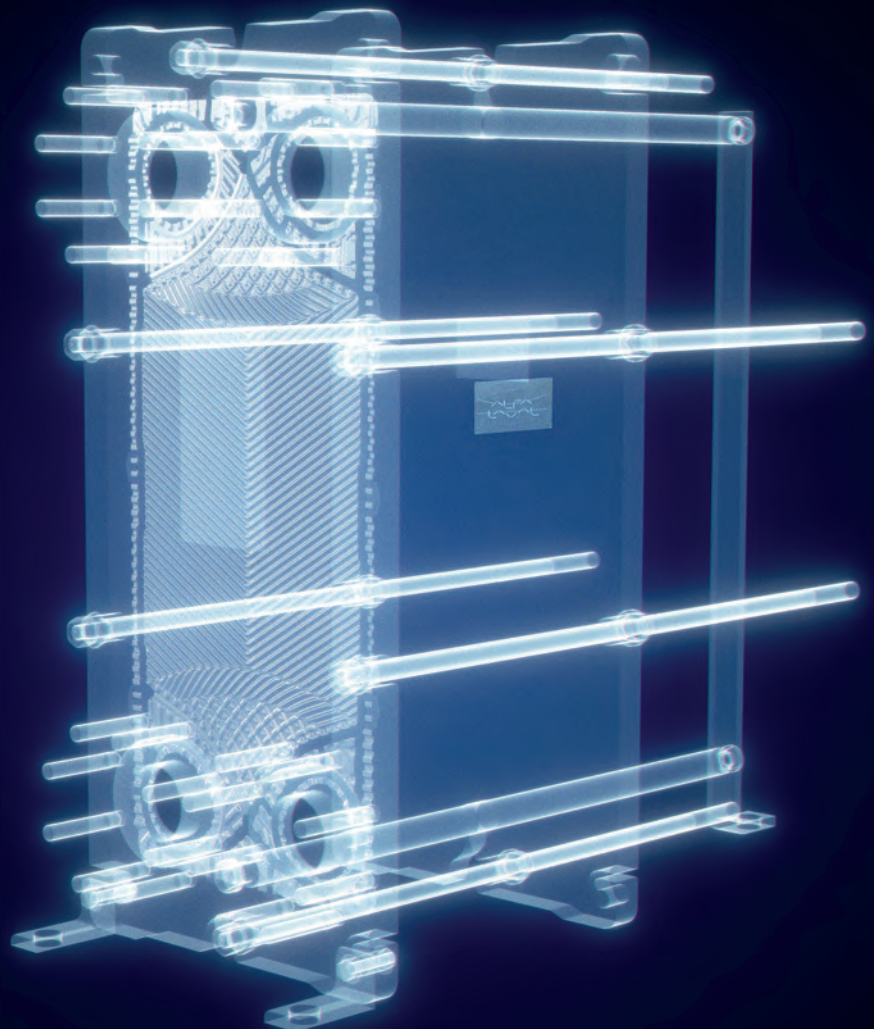

# Plates

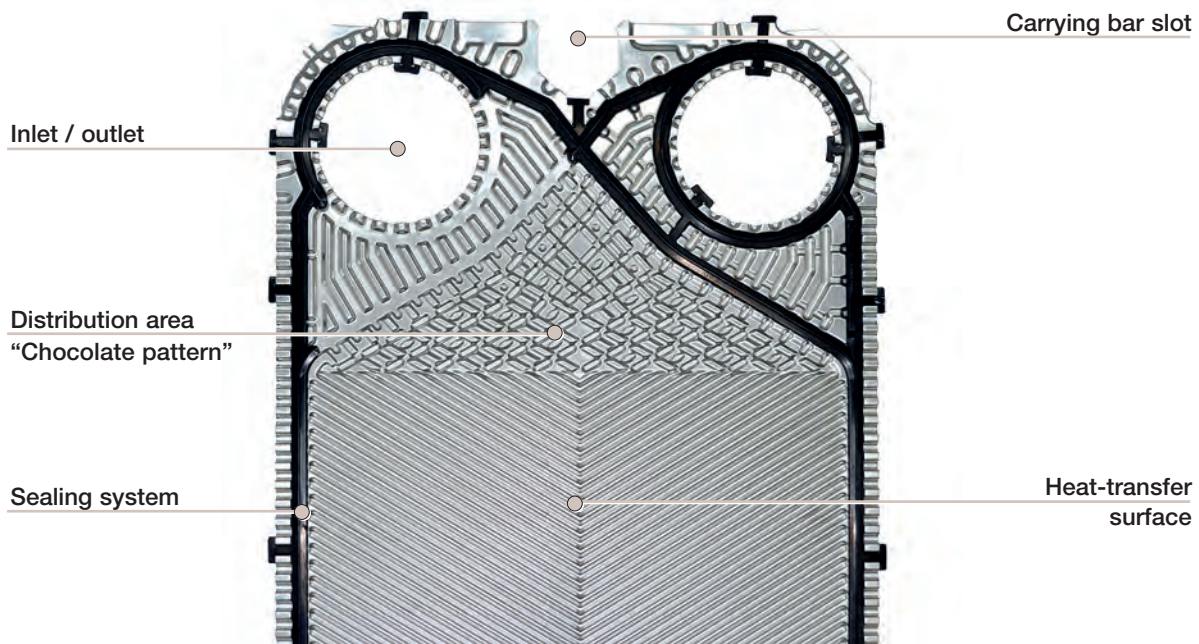
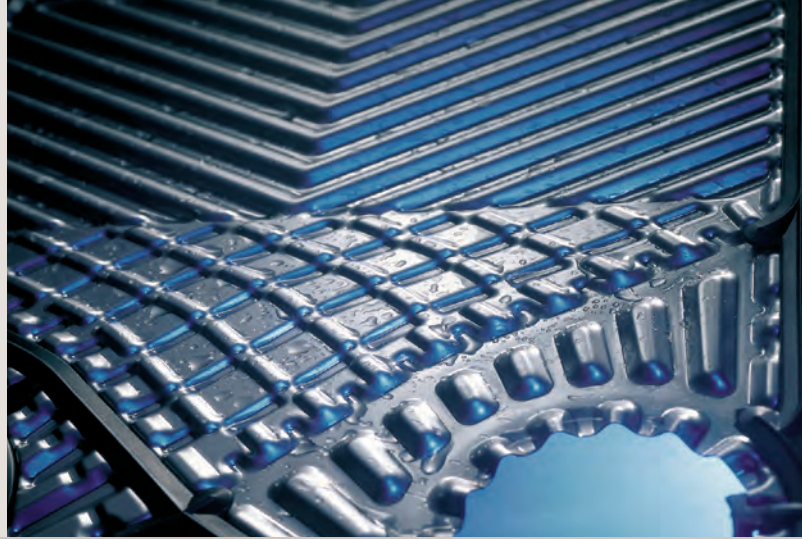

## The heat-transfer surface

The heat exchanger plates are pressed in a so-called herringbone corrugation pattern. When two plates are superimposed with opposing herringbone patterns, this type of corrugation generates a helix-like flow with very high turbulence, thus producing the essential condition for achieving high transfer coefficients and effective heat exchanger self-cleaning. By changing the plate corrugation pattern, the heat exchanger can be used in different processes, even those with very dirty media.

## The distribution area

The plate distribution is pressed in a so called chocolate pattern, an Alfa Laval innovation. This type of corrugation has numerous advantages. Among the most important are; it optimises flow distribution over the entire transfer surface, ensuring highest energy efficiency.

Dead spots, that are the main cause of corrosion and fouling, are eliminated. Customers will benefit from reduced maintenance cost and increased uptime.

## Special plates

### Double-wall plates

Double-wall gasketed plate heat exchangers are ideal for use with fluids that must not be allowed to mix. Pairs of identical plates are laser-welded

around the ports. The gasket is installed in the conventional manner and the welded plate pairs are assembled in a plate pack in the same way as ordinary single plates.

In the unlikely event of leakage through a plate because of a puncture or crack, the leaking fluid will never come into contact with the fluid in the other circuit, as it will be stopped by the double plate and flow outside the heat exchanger.

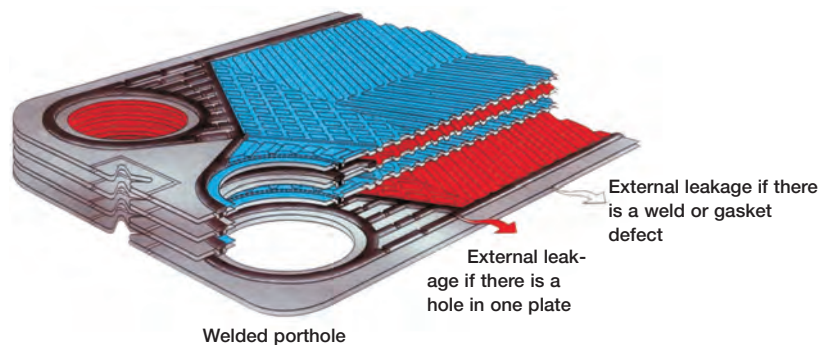



The world's tallest building stays cool in the scorching desert sun thanks to an innovative thermal ice-storage system and Alfa Laval gasketed plate heat exchangers. Burj Khalifa, Dubai, United Arab Emirates.

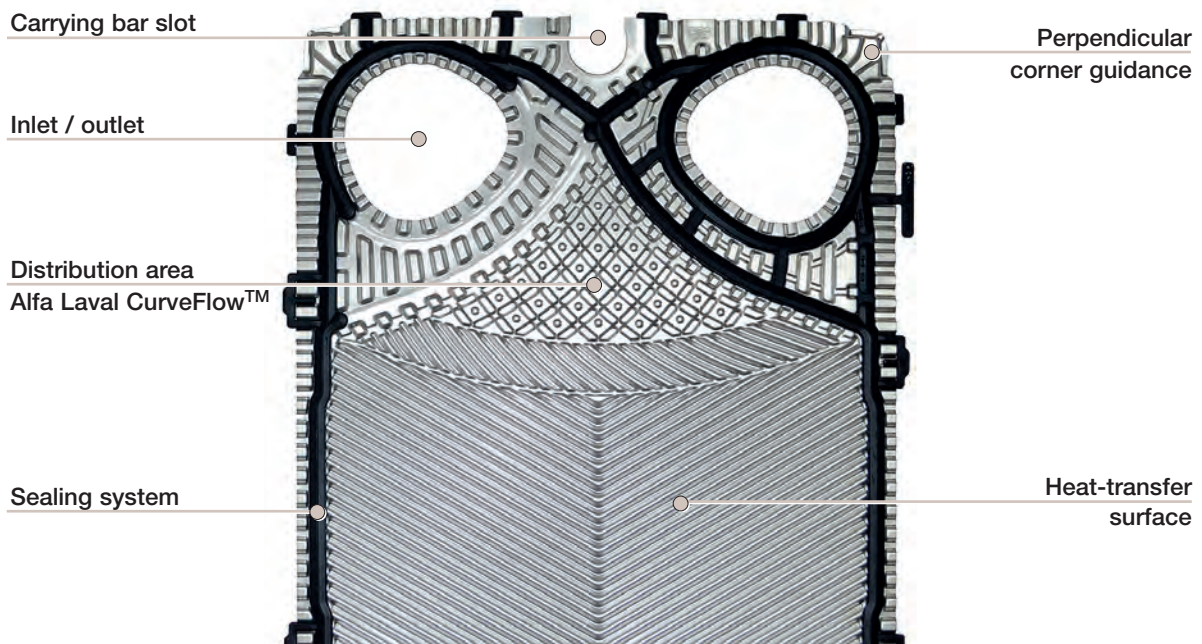

## New plate innovations

### Alfa Laval CurveFlow™

The new design of the distribution area means superior flow distribution and more of the available pressure drop over the main heat transfer area.

This results in a number of benefits for the customer:

- A more compact heat exchanger – less plates needed.
- Increased energy efficiency – better flow distribution reduces the risk of fouling build up, reducing the need for increased pumping power to compensate for higher pressure drop.
- Reduced maintenance costs – fewer plates mean faster cleaning and low cost for spares.

### Up to 15% higher efficiency

With the new Alfa Laval CurveFlow™ design the media is more optimal distributed over the entire plate width. Additionally, the cross corrugation pattern between the distribution surface and the main heat transfer area gives improved heat transfer. Compared to a traditional plate design it is also possible to use thinner plates at high pressures. Total improvement of the heat transfer efficiency is up to 15%.

### Higher flow capacity

Thanks to the non-circular ports, the port area in the plate has increased compared to a conventional circular design. This equals to higher flow capacity at the same velocity, allowing higher utilization.

### Up to 40% improvement in self-cleaning capability

Thanks to the new Alfa Laval CurveFlow™ design the media will have up to 20% higher velocity at the far end of the plate width. This will improve the shear stress over the heat transfer area by up to 40%, thus minimizing the risk of fouling build-up at the most critical part of the plate.

### Perpendicular corner guiding

The new corner guiding design ensures that the plate pack is perfectly aligned independent of the number of plates. A perfect alignment ensures a reliable performance of the heat exchanger and faster closing of the unit after service.

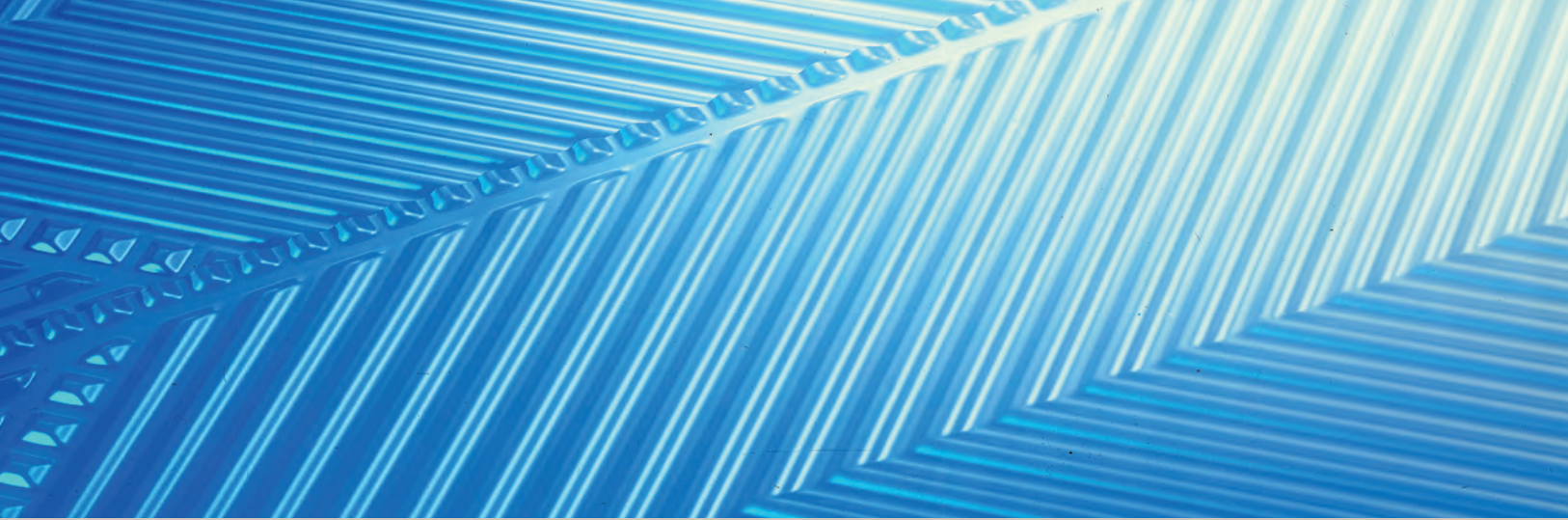

## Channel types

**We have two plate corrugations (L and H)**

These form three different channels (L, M, H)



**L: Low theta**

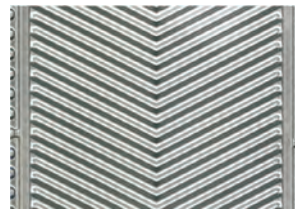

**H: High theta**



**L + L = L channel**



**L + H = M channel**

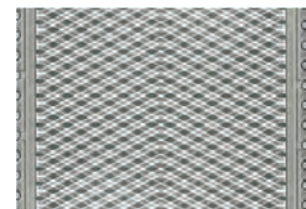

**H + H = H channel**

Optimal channel type is selected on the basis of the temperature program to be satisfied and the maximum permissible pressure drop

## Channel characteristics

**Low turbulence  
and pressure drop**



**“L” channels**



**Medium turbulence  
and pressure drop**



**“M” channels**



**High turbulence  
and pressure drop**

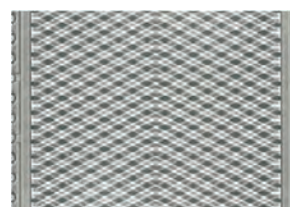

**“H” channels**



### Advantages

- Efficient heat transfer
- High turbulence
- Variable thermal length
- Low pressure drop

### Benefits

- Increased heat recovery
- High self-cleaning coefficients
- Low heat-transfer surface area
- Low pumping costs



# Gaskets



The gaskets in Alfa Laval gasketed plate heat exchangers are parts of an advanced hydraulic sealing system designed for high performance and long operating life.

Our gasket profiles produce a highly efficient seal, minimizing the risk of leakage.

The performance of a heat exchanger is influenced by different components and places very high demands on the gasket system. To obtain highest performance, it is important that the plate and gasket are designed together.

A correctly designed gasket has a high enough sealing force to prevent leakage, but not too high in order to prevent gasket and gasket groove damages. Alfa Laval offers gaskets which are based on the roof top gasket profile, as this has proven to be most effective.

The rib top gasket family is the next generation gasket developed by Alfa Laval. It is a further development of the traditional roof top gasket profile.

The roof on this next generation gasket is less edgy and there is a rib on top of it. The rib top profile with less rubber mass gives an outstanding sealing performance, reducing the risk of gasket and plate damages and leakages due to plate misalignment.

All gaskets are made from a single uniform rubber by the best suppliers. In addition, they are moulded in one piece, guaranteeing exact gasket geometry with no weak links from vulcanisation. Gaskets are available in a wide range of elastomers, the most common being Nitrile rubber and EPDM.

Alfa Laval was the first heat-exchanger manufacturer to develop and use the glue-free clip-on system that makes it easier to replace gaskets during maintenance, thus saving time. Recently Alfa Laval introduced a new glue-free system called Alfa Laval ClipGrip™ which improves the gasket fastening and sealing reliability even further.

Gasket groove design ensures minimum contact between the gasket and the media, helping extend the heat exchanger's operating life. The groove on the plate and the gasket match perfectly, ensuring that the gasket is fully supported.



Examples of Alfa Laval roof/rib top gasket family



Glue-free ClipGrip™ system



Glue-free Clip-on system

# Frame

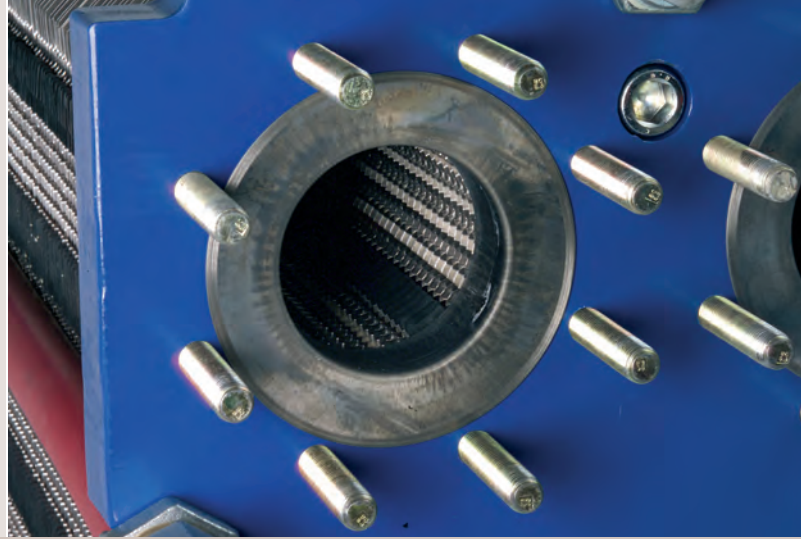

## Designed with lowest cost of ownership

The frame features will ensure:

- Reduced maintenance cost
- Reduced spare part costs
- Staff safety
- Time savings

Alfa Laval gasketed plate heat exchangers of all sizes can be opened quickly and easily for inspection and gasket replacement by one man using standard tools. They are reassembled just as easily. Our large units feature Alfa Laval's 5-point alignment system. Precise positioning of the plates horizontally and vertically ensures efficient sealing throughout the plate pack. A roller on the pressure plate, and bearing boxes on the four tightening bolts, make opening and closing an easy task.

Simpler in design, our smaller gasketed plate heat exchangers are equally service-friendly, while keeping costs to a minimum. During reassembly, alignment of the plate pack is achieved using the round carrying and guide bar. Corner guides lock the plates in position and ensure perfect final alignment.

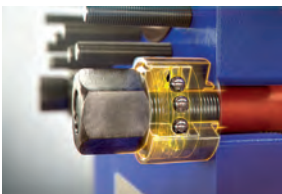

**Bearing box** – makes opening and closing the heat exchanger easier – will reduce maintenance time and increase staff safety.



**Key hole bolt opening** reduce risk of tightening bolts falling out and allows bolt to be removed sideways – will reduce installation and maintenance cost and ensure staff safety.



**5-point alignment system and perpendicular corner guidance.** Perfect plate alignment avoiding plate pack leakages and additional necessary openings & closings of the plate heat exchanger – will reduce maintenance time and spare part cost.



**Lock washer** requires one man instead of two to loosen the tightening bolts and reduce the risk of bolts falling out – will reduce maintenance cost and increase staff safety.

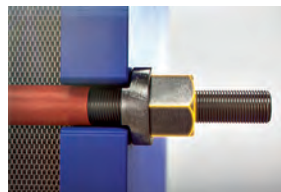
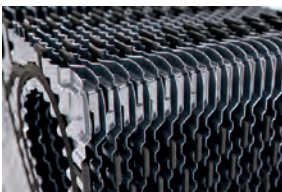

**Elongated nuts** reduce nuts seizing on tightening bolt – will reduce cost for maintenance and spare parts.



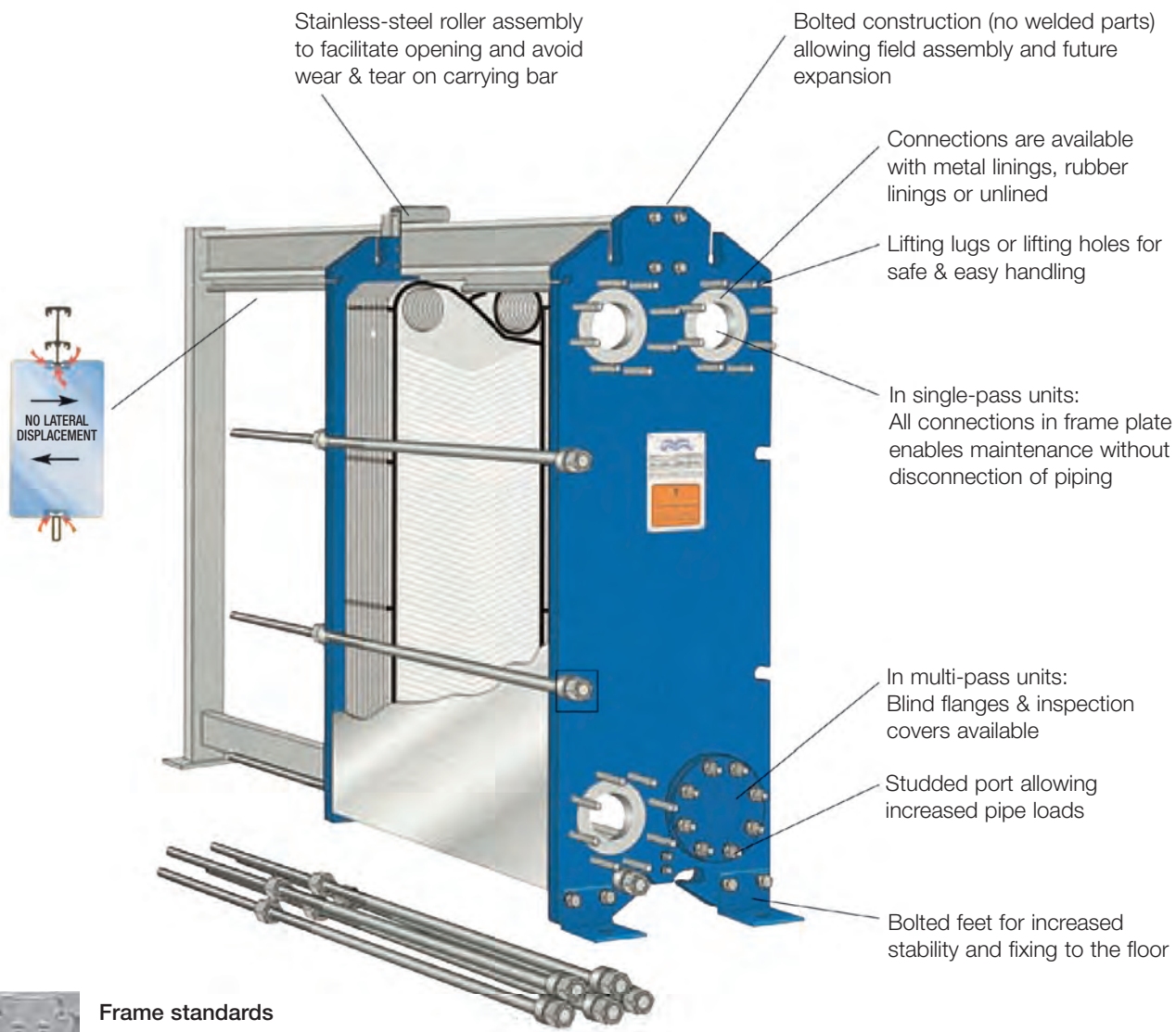
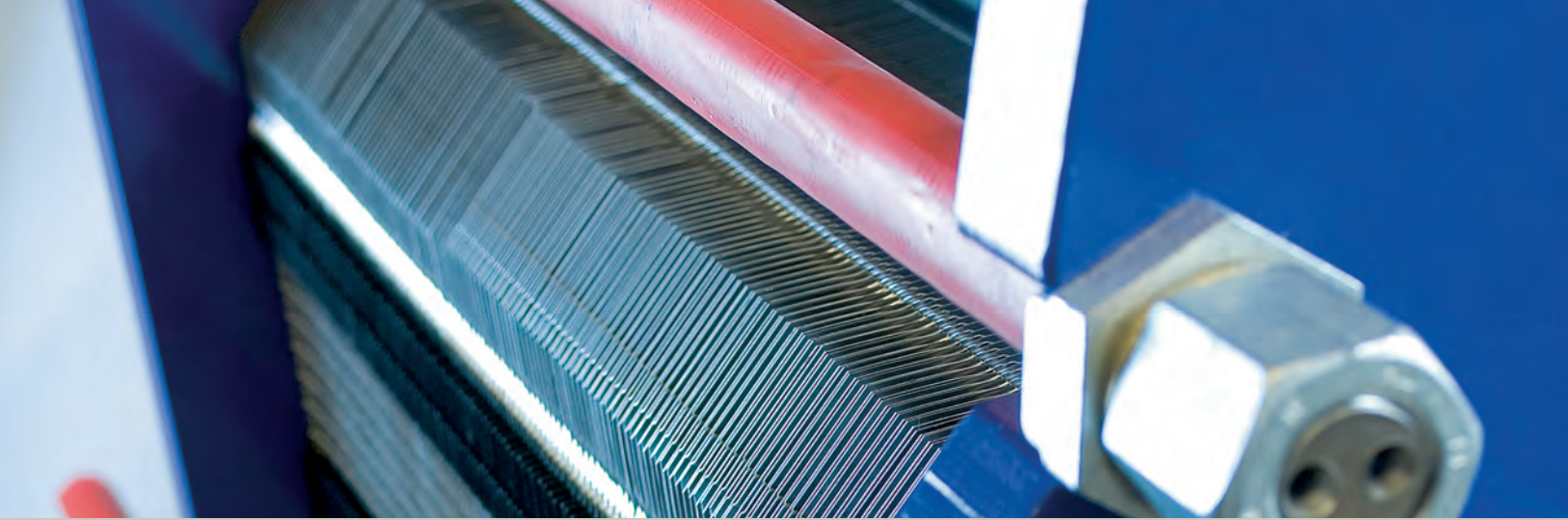

- Frame standards**
- ASME, U and UM
  - PED/CE marking



- Alfa Laval standard for other, local PV rules.

# When performance is crucial



## Alfa Laval AlfaQ™ AHRI-certified gasketed plate heat exchangers

When performance is crucial, each component of an industry system must be optimized to perform exactly as specified.

The Air Conditioning, Heating and Refrigeration Institute (AHRI) Standard 400 certification is an independent, third-party verification of thermal performance. AHRI 400 is now a global standard, assuring customers worldwide that the heat exchangers they choose will perform according to specification.

Performance certification verifies that the product performs in accordance with the manufacturer's published ratings, and is particularly useful in applications such as district-cooling substations, ice-storage systems, data centres and free-cooling systems.

Alfa Laval was the first to offer a broad range of heat exchanger innovations – the AlfaQ™ range – that are certified to AHRI 400.

**Certification leads the “green” wave**  
AHRI-certified heat exchangers can meet the Leadership in Energy and Environmental Design (LEED) standards for heating and cooling applications. LEED is an internationally recognized mark, providing building owners and

operators with a framework for identifying and implementing practical and measurable green building design, construction, operations and maintenance solutions.

Through its certification program and standards, AHRI strives to help customers save energy, improve their productivity and contribute to a better environment.

### **AHRI Certification Procedures and Benefits**

Performance deficiencies in an industry system are difficult to detect and can result in much higher energy costs. Certification of all components assures the buyer that the system will perform optimally.

To certify a product to AHRI standards, the manufacturer submits specifications and performance data to AHRI for performance evaluation and potential certification.

The certification assures buyers and users that:

- The gasketed plate heat exchanger will perform in accordance with the manufacturer's published ratings.
- Product performance can be easily compared for their specific application.

Alfa Laval has accomplished a 100% success rate in the AHRI performance certification program for more than a decade.

### **Cost-effective for everyone involved**

#### *Consultants*

- Allows for the design of a system in which all the major components are independently performance certified, ensuring that targets on power consumption and climate control can be met.
- Provides a verifiable basis for heat exchanger selection.
- Protects the owner and consulting engineer from performance concerns during commissioning and after installation.

#### *Contractors*

- Eliminates field acceptance tests of each component, thereby reducing payment hold-back times after commissioning.
- Ensures that all certified gasketed plate heat exchangers included in proposals will deliver the stated thermal performance.
- Reduces troubleshooting time during commissioning and after start-up.

#### *End users*

- Reduces lifetime operating costs significantly by assuring a more energy-efficient system.
- Ensures full investment value by reducing costs for field tests and additional component performance margins.





## Alfa Laval AlfaQ™ gasketed plate heat exchangers, the optimal choice

Alfa Laval's broad range of heat exchangers for industry applications include gasketed, semi-welded, fully-welded, double-wall plate, and brazed heat exchangers. The AlfaQ™ Series are part of our gasketed plate heat exchanger portfolio.

AlfaQ™ gasketed plate heat exchangers are available to meet most heat-transfer

requirements – whether large or small – and include a three-year warranty, demonstrating our commitment to optimizing the performance of our customers' processes.

AlfaQ™ Series is the optimal choice when performance is crucial.



# Insulation



## Insulation

Insulation, designed for industry applications, is available for most gasketed plate heat exchanger models. There are two different types of insulation – heating and cooling insulation.

The reason for having two different types is that the mineral wool will be wet from condensing water if used when the heat exchanger temperature is lower than the surrounding temperature. Polyurethane is more expensive than mineral wool, but technically the cooling insulation can be used for heating duties as well.

## Drip tray

The Alfa Laval drip tray insulates the heat exchanger from the floor, and it also collects any condensate formed on the outside of the heat exchanger. The drip tray also collects any remaining water (after drainage) in the gasketed plate heat exchanger when the unit is opened for inspection or maintenance. The drip tray consists of 0.75 mm hot galvanized steel plates, 50 mm polyurethane foam, supports of waterproof wood, and a draining valve.



## Heating insulation

Heating insulation consists of 65 mm of mineral wool, clad with a 1 mm aluminium sheet on the outside and aluminium foil on the inside. It covers all sides of the gasketed plate heat exchanger including the frame and pressure plate, except downwards. The different parts are held together with snap catches.



## Cooling insulation

Cooling insulation consists of 60 mm of polyurethane, clad with a 1 mm aluminium sheet on the outside and aluminium foil on the inside. It covers all sides of the gasketed plate heat exchanger including the frame and pressure plate, except downwards, where there is a galvanized drip tray. The different parts are held together with snap catches.

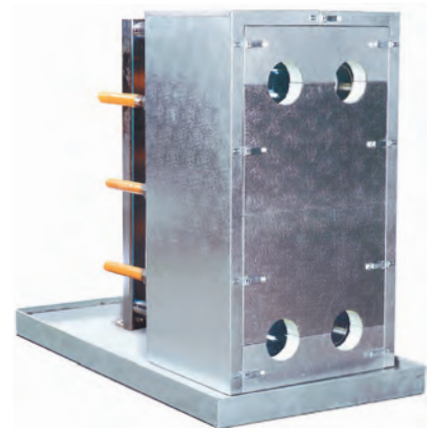

## Protection sheet

A protection sheet is a device covering all sides of the plate pack except downwards. It is used to prevent persons from getting injured if a sudden leak of hot, corrosive or toxic media should occur. The Alfa Laval protection sheet consists of one or more aluminium or stainless-steel (AISI 304) sheet(s) formed to fit the gasketed plate heat exchanger. On most frames the sheet is fitted between the plate pack and the tightening bolts.



# Alfa Laval Service



## Extending performance

Alfa Laval's global service network ensure optimal performance of your Alfa Laval equipment throughout its life cycle. To bring you maximum uptime and return on investment, our committed team draws on 130 years of process and application knowledge.

Our goal is to optimize the performance of your process by for instance redesigning your gasketed plate heat exchanger to match your new process requirements or reconditioning it to a good-as-new state, thus making sure to maximize uptime.

But we go even further. We also ensure our top-class service engineers are with you when and where you need them, at your site or in our service centres.

## Complete 360° Service Portfolio for gasketed plate heat exchangers

### Start-up

- Installation
- Commissioning

### Maintenance

- Reconditioning
- Cleaning services
- Service tools
- Spare parts

### Support

- Telephone support
- Exclusive stock
- Training
- Troubleshooting
- Technical documentation

### Improvements

- Equipment upgrades
- Redesign
- Replacement & Retrofit

### Monitoring

- Performance Audit
- Condition Audit

### Reconditioning

Reconditioning your gasketed plate heat exchanger can extend its lifetime; minimize operational costs; ensure safety, quality and productivity; and satisfy new environmental legislation by improving energy efficiency.

You can choose from a number of pre-defined reconditioning packages, or customize a package from the complete list of Alfa Laval reconditioning services, to match your requirements for turn-around time, budget, brand and/or application.

### Spare parts

Correct material quality can make a huge difference to your process. By using genuine Alfa Laval Spare Parts you can rest assured that the correct material is specified according to its intended use.

Alfa Laval genuine plates are made using a single-step pressing method ensuring uniform plate strength and thickness over the entire plate – dramatically reducing the risk of fatigue cracking.

Alfa Laval genuine rubber gaskets ensure tighter seals, longer life and more uptime for gasketed plate heat exchangers.

**Uptime** – skilled experts assist you with proper service that prevents unplanned interruptions, using certified materials.

**Availability** – we are committed to providing easy access to specialist support and the right parts for your Alfa Laval equipment.

**Optimization** – our innovative services and solutions are available to help your existing equipment adapt to your evolving needs.





# Ten top tips



To keep your gasketed plate heat exchanger in tip top condition

- 1 Make sure that the operating conditions (temperatures and flow rates) comply with the design specifications.
- 2 At start-up, vent the heat exchanger but open and close the valves slowly to avoid pressure surges and water hammer.
- 3 Use upstream filters and strainers to remove particulate fouling and protect the heat exchanger.
- 4 On a daily basis check for any changes in temperature or pressure and check for any signs of external leaks.
- 5 On a regular basis keep the tightening bolts clean and well-lubricated.
- 6 Use condition monitoring techniques to avoid having to open the gasketed plate heat exchanger for inspection.
- 7 Use Cleaning-In-Place (CIP) to avoid the need to open the heat exchanger for cleaning.



- 8 Always keep stand-by units clean and dry. If a heat exchanger is taken out of service, flush with fresh water and drain it completely.
- 9 Protect heat exchangers from water splash and rain. Avoid exposure to ultra violet rays and ozone typically generated from electrical sources.
- 10 Only use genuine spare parts for guaranteed performance, reliability and equipment life. Maintain a stock of essential spare parts and follow the storage instructions.

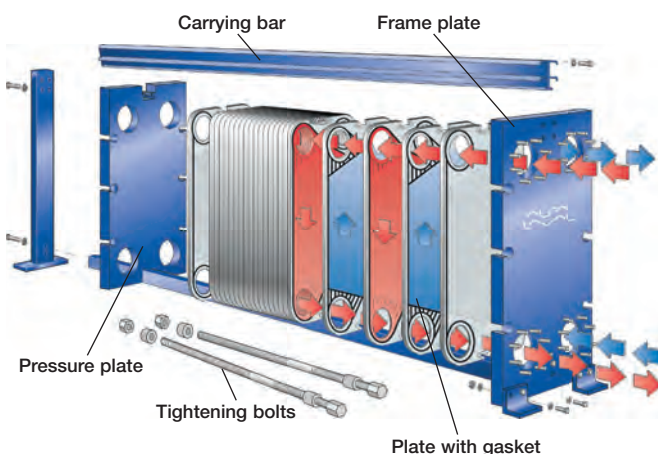

Alfa Laval Service  
Extending Performance







## Technical specifications Industrial line



Model	T2	M3	TL3	T5	M6	TL6	TS6
Max. flow rate kg/s/GPM	2/30	4/60	5/80	14/220	16/250	20/300	20/300
Max. temperature C° (PED) /F° (ASME)	180/-	180/300	180/350	180/350	180/350	180/350	180/350
Max. design pressure bar (PED) /psi (ASME)	16/-	16/150	16/150	16/150	25/300	25/300	25/300
Read all about it on page	6:17	6:19	6:21	6:23	6:25	6:27	6:29



Model	T8	M10	TL10	M15	TL15	TS20	T20
Max. flow rate kg/s/GPM	30/475	50/800	50/800	80/1300	120/1900	190/3040	225/3600
Max. temperature C° (PED) /F° (ASME)	180/350	180/350	180/350	180/350	180/350	180/350	180/350
Max. design pressure bar (PED) /psi (ASME)	16/150	25/300	25/400	30/300	30/400	30/400	30/400
Read all about it on page	6:31	6:33	6:35	6:37	6:39	6:41	6:43

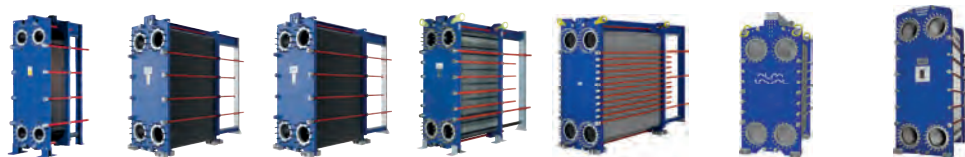

Model	MX25	TS35	T35	TL35	T45	TS50	T50
Max. flow rate kg/s/GPM	350/5600	550/8700	550/8700	650/10400	1000/16000	1300/20800	1300/20800
Max. temperature C° (PED) /F° (ASME)	180/350	180/350	180/350	180/350	250/350	180/350	180/350
Max. design pressure bar (PED) /psi (ASME)	30/400	25/400	25/400	30/400	16/250	25/300	25/300
Read all about it on page	6:45	6:47	6:49	6:51	6:53	6:55	6:57



# Technical specifications AlfaQ



Model	AQ1A	AQ1	AQ1L	AQ2A	AQ2	AQ2L	AQ2S
Max. flow rate kg/s/GPM	2/30	4/60	5/80	14/220	16/250	20/300	20/300
Max. temperature C° (PED) /F° (ASME)	180/-	180/300	180/350	180/350	180/350	180/350	180/350
Max. design pressure bar (PED) /psi (ASME)	16/-	16/150	16/150	16/150	25/300	25/300	25/300
Read all about it on page	6:59	6:61	6:63	6:65	6:67	6:69	6:71



Model	AQ3	AQ4	AQ4L	AQ6	AQ6L	AQ8S	AQ8
Max. flow rate kg/s/GPM	30/475	50/800	50/800	80/1300	120/1900	190/3040	225/3600
Max. temperature C° (PED) /F° (ASME)	180/350	180/350	180/350	180/350	180/350	180/350	180/350
Max. design pressure bar (PED) /psi (ASME)	16/150	25/300	25/400	30/300	30/400	30/400	30/400
Read all about it on page	6:73	6:75	6:77	6:79	6:81	6:83	6:85

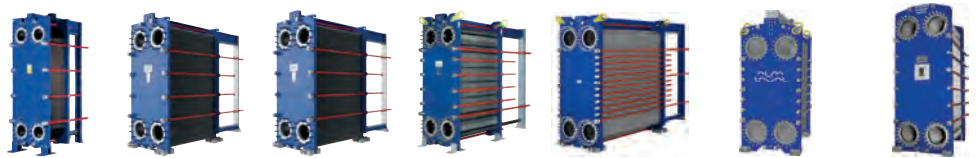

Model	AQ10	AQ14S	AQ14	AQ14L	AQ18	AQ20S	AQ20
Max. flow rate kg/s/GPM	350/5600	550/8700	550/8700	650/10400	1000/16000	1300/20800	1300/20800
Max. temperature C° (PED) /F° (ASME)	180/350	180/350	180/350	180/350	250/350	180/350	180/350
Max. design pressure bar (PED) /psi (ASME)	30/400	25/400	25/400	30/400	16/250	25/300	25/300
Read all about it on page	6:87	6:89	6:91	6:93	6:95	6:97	6:99



# Alfa Laval T2

## Gasketed plate-and-frame heat exchanger

### Applications

General heating and cooling duties.

### Standard design

The plate heat exchanger consists of a pack of corrugated metal plates with portholes for the passage of the two fluids between which heat transfer will take place.

The plate pack is assembled between a fix frame plate and a movable pressure plate and compressed by tightening bolts. The plates are fitted with a gasket which seals the interplate channel and directs the fluids into alternate channels. The number of plates is determined by the flow rate, physical properties of the fluids, pressure drop and temperature program. The plate corrugations promote fluid turbulence and support the plates against differential pressure.

The plate and the pressure plate are suspended from an upper carrying bar and located by a lower guiding bar.

Connections are located in the frame plate or, if either or both fluids make more than a single pass within the unit, in the frame and pressure plates.

### Typical capacities

#### Liquid flow rate

Up to 2 kg/s (30 gpm), depending on media, permitted pressure drop and temperature program.

#### Plate types

T2-B

#### Frame types

FG

### Working principle

Channels are formed between the plates and the corner ports are arranged so that the two media flow through alternate channels. The heat is transferred through the plate between the channels, and complete counter-current flow is created for highest possible efficiency. The corrugation of the plates provides the passage between the plates, supports each plate against the adjacent one and enhances the turbulence, resulting in efficient heat transfer.



T2B-FG

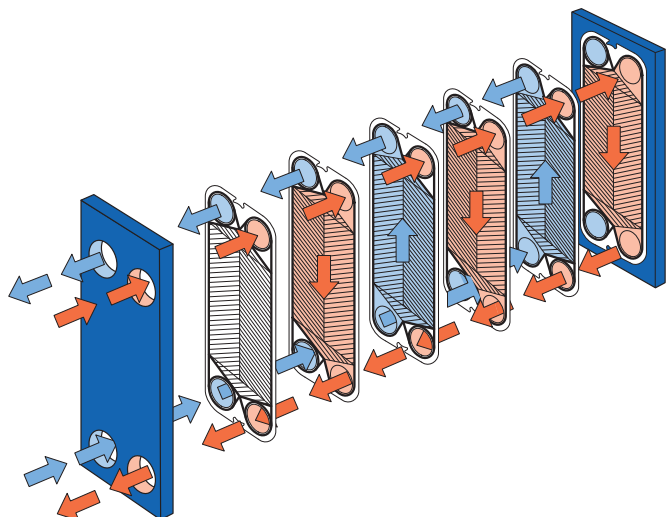

Flow principle of a plate heat exchanger



## STANDARD MATERIALS

### Frame plate

Mild steel, Epoxy painted

### Nozzles

Pipe: Stainless steel, Titanium

### Plates

Stainless steel Alloy 316, Titanium

### Gaskets

Nitrile, EPDM

## TECHNICAL DATA

Pressure vessel code pvcALS™

Mechanical design pressure (g) / temperature

FG 1.6 MPa / 180°C

Maximum heat transfer surface

1.0 m<sup>2</sup> (10.76 sq. ft)

### Connections

Straight pipe thread ISO-R 3/4"

### Particulars required for quotation

- Flow rates or heat load
- Temperature program
- Physical properties of liquids in question (if not water)
- Desired working pressure
- Maximum permitted pressure drop

## Dimensions mm (inch)

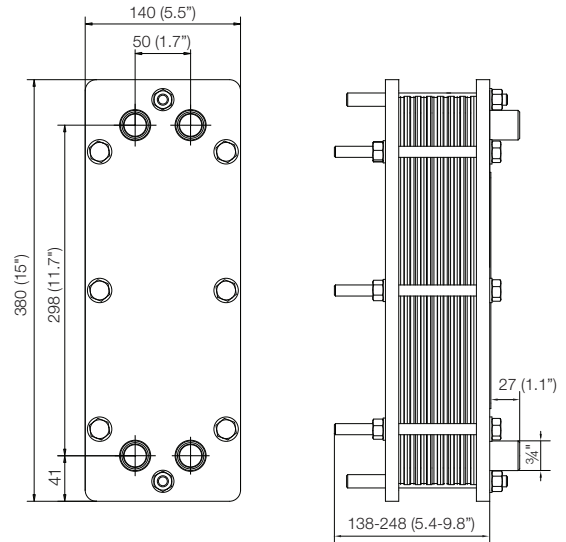

### How to contact Alfa Laval

Up-to-date AlfaLaval contact details for all countries are always available on our website on [www.alfalaval.com](http://www.alfalaval.com)



## Alfa Laval M3

### Gasketed plate-and-frame heat exchanger

#### Applications

General heating and cooling duties. Heating by means of steam.

#### Standard design

The plate heat exchanger consists of a pack of corrugated metal plates with portholes for the passage of the two fluids between which heat transfer will take place.

The plate pack is assembled between a fix frame plate and a movable pressure plate and compressed by tightening bolts. The plates are fitted with a gasket which seals the interplate channel and directs the fluids into alternate channels. The number of plates is determined by the flow rate, physical properties of the fluids, pressure drop and temperature program. The plate corrugations promote fluid turbulence and support the plates against differential pressure.

The plate and the pressure plate are suspended from an upper carrying bar and located by a lower guiding bar.

Connections are located in the frame plate or, if either or both fluids make more than a single pass within the unit, in the frame and pressure plates.

#### Typical capacities

##### Liquid flow rate

Up to 4 kg/s (60 gpm), depending on media, permitted pressure drop and temperature program.

##### Plate types

M3 and M3-X, where M3 provides parallel and M3-X diagonal flow (see figures on the next page).

M3D, double wall plates.

##### Frame types

FG

##### Water heating by steam

50 to 250 kw

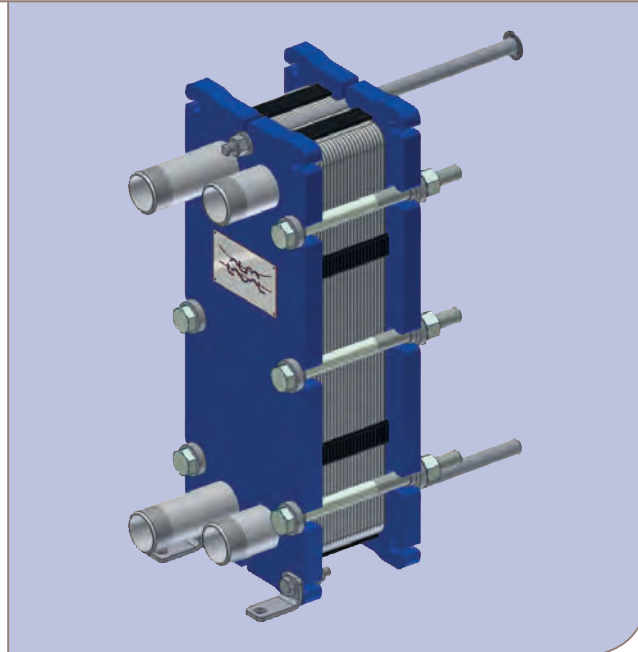

M3-FG

### Working principle

Channels are formed between the plates and the corner ports are arranged so that the two media flow through alternate channels. The heat is transferred through the plate between the channels, and complete counter-current flow is created for highest possible efficiency. The corrugation of the plates provides the passage between the plates, supports each plate against the adjacent one and enhances the turbulence, resulting in efficient heat transfer.

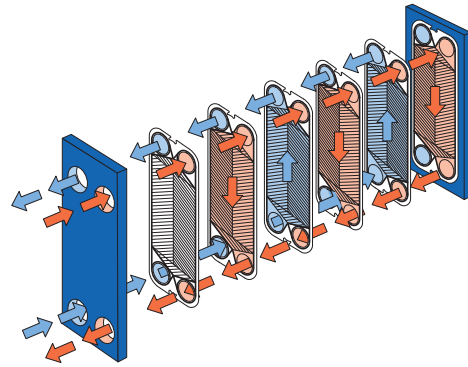

Flow principle of an M3 plate heat exchanger

### STANDARD MATERIALS

#### Frame plate

Mild steel, Epoxy painted

#### Nozzles

Carbon steel

Pipe: Stainless steel, Titanium

#### Plates

Stainless steel Alloy 316, Titanium

#### Gaskets (Clip-on)

Nitrile, EPDM, Viton®

Other grades and material available on request.

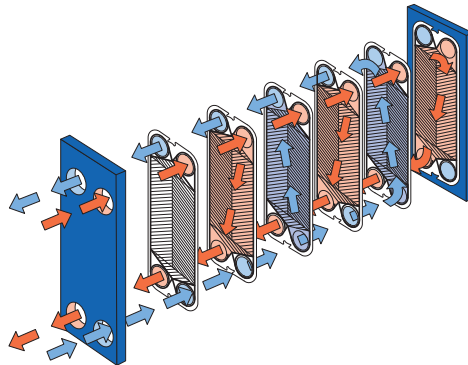

Flow principle of an M3X plate heat exchanger

### TECHNICAL DATA

Pressure vessel codes PED, ASME, pvcALS™

Mechanical design pressure (g) / temperature

FG PED, pvcALS™ 1.6 MPa / 180°C

FG ASME 150 psig / 350°F

#### Maximum heat transfer surface

3.9 m<sup>2</sup> (40 sq. ft)

#### Connections

FG PED Size 1¼" Pipe, thread ISO-R 1¼"

FG pvcALS™ Size 1¼" Pipe, thread ISO-R 1¼"

FG pvcALS™ Size 1¼" Internal thread ISO-G 1¼", carbon steel

FG ASME Size 1¼" Pipe, thread NPT 1¼"

#### Particulars required for quotation

- Flow rates or heat load
- Temperature program
- Physical properties of liquids in question (if not water)
- Desired working pressure
- Maximum permitted pressure drop
- Available steam pressure

#### Dimensions

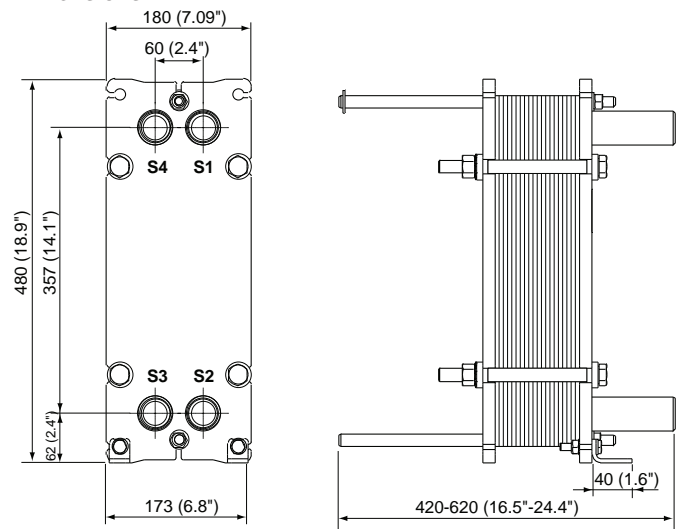

#### Measurements mm (inch)

The number of bolts may vary depending on pressure rating.

#### How to contact Alfa Laval

Up-to-date AlfaLaval contact details for all countries are always available on our website on [www.alfalaval.com](http://www.alfalaval.com)



# Alfa Laval TL3

## Gasketed plate-and-frame heat exchanger

### Applications

General heating and cooling duties.

### Standard design

The plate heat exchanger consists of a pack of corrugated metal plates with portholes for the passage of the two fluids between which heat transfer will take place.

The plate pack is assembled between a fix frame plate and a movable pressure plate and compressed by tightening bolts. The plates are fitted with a gasket which seals the interplate channel and directs the fluids into alternate channels. The number of plates is determined by the flow rate, physical properties of the fluids, pressure drop and temperature program. The plate corrugations promote fluid turbulence and support the plates against differential pressure.

The plate and the pressure plate are suspended from an upper carrying bar and located by a lower guiding bar.

Connections are located in the frame plate or, if either or both fluids make more than a single pass within the unit, in the frame and pressure plates.

### Typical capacities

#### Liquid flow rate

Up to 5 kg/s (80 gpm), depending on media, permitted pressure drop and temperature program.

#### Plate types

TL3-B, TL3-P

TL3-BD, double wall plates

#### Frame types

FG

### Working principle

Channels are formed between the plates and the corner ports are arranged so that the two media flow through alternate channels. The heat is transferred through the plate between the channels, and complete counter-current flow is created for highest possible efficiency. The corrugation of the plates provides the passage between the plates, supports each plate against the adjacent one and enhances the turbulence, resulting in efficient heat transfer.



TL3-FG

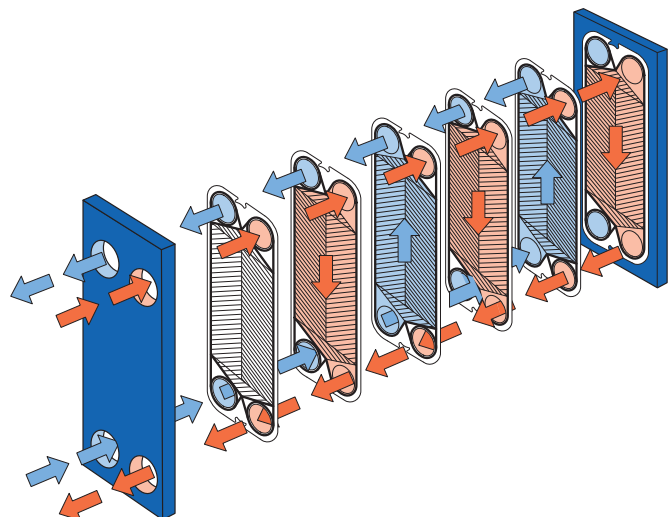

Flow principle of a plate heat exchanger



## STANDARD MATERIALS

### Frame plate

Mild steel, Epoxy painted

### Nozzles

Carbon steel

Pipe: Stainless steel, Titanium

### Plates

Stainless steel: Alloy 316 / Alloy 304, Titanium, Alloy 254 SMO.

### Gaskets

Nitrile, EPDM, Viton®

Other grades and material available on request.

## TECHNICAL DATA

Pressure vessel codes PED, ASME, pvcALS™

Mechanical design pressure (g) / temperature

FG pvcALS™ 1.6 MPa / 180°C

FG PED 1.6 MPa / 180°C

FG ASME 150 psig / 356°F

### Maximum heat transfer surface

10.9 m<sup>2</sup> (117.3 sq.ft)

### Connections

FG PED Size 1¼" Pipe, thread ISO-R 1¼"

FG pvcALS™ Size 1¼" Pipe, thread ISO-R 1¼" and NPT 1¼"

FG pvcALS™ Size 1¼" Internal thread ISO-G 1¼", carbon steel

FG ASME Size 1¼" Pipe, thread NPT 1¼"

## Dimensions

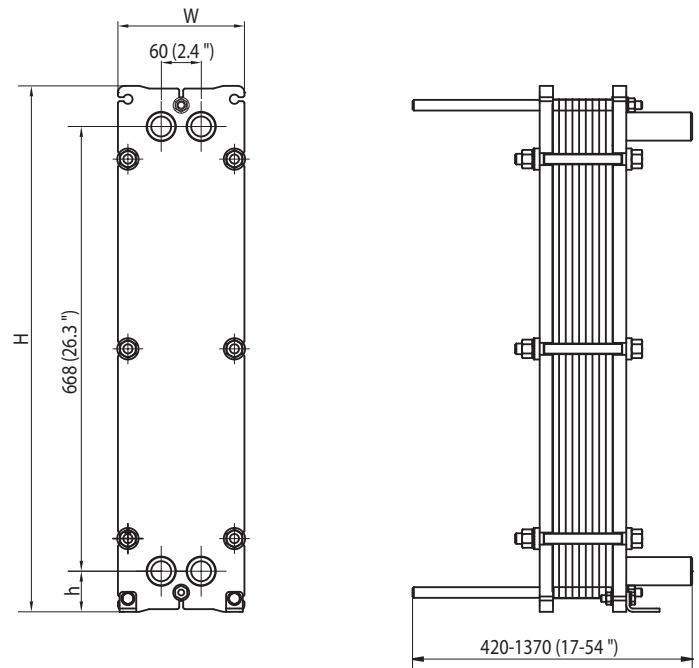

## Measurements mm (inch)

Type	H	W	h
TL3-FG	790 (31.1")	190 (7.5")	61 (2.4")

## Particulars required for quotation

- Flow rates or heat load
- Temperature program
- Physical properties of liquids in question (if not water)
- Desired working pressure
- Maximum permitted pressure drop

### How to contact Alfa Laval

Up-to-date AlfaLaval contact details for all countries are always available on our website on [www.alfalaval.com](http://www.alfalaval.com)



# Alfa Laval T5

## Gasketed plate-and-frame heat exchanger

### Applications

General heating and cooling duties.

### Standard design

The plate heat exchanger consists of a pack of corrugated metal plates with portholes for the passage of the two fluids between which heat transfer will take place.

The plate pack is assembled between a fix frame plate and a movable pressure plate and compressed by tightening bolts. The plates are fitted with a gasket which seals the interplate channel and directs the fluids into alternate channels. The number of plates is determined by the flow rate, physical properties of the fluids, pressure drop and temperature program. The plate corrugations promote fluid turbulence and support the plates against differential pressure.

The plate and the pressure plate are suspended from an upper carrying bar and located by a lower guiding bar.

Connections are located in the frame plate or, if either or both fluids make more than a single pass within the unit, in the frame and pressure plates.

### Typical capacities

#### Liquid flow rate

Up to 14 kg/s (222 gpm), depending on media, permitted pressure drop and temperature program.

#### Plate types

T5-B, T5-M

#### Frame types

FG

### Working principle

Channels are formed between the plates and the corner ports are arranged so that the two media flow through alternate channels. The heat is transferred through the plate between the channels, and complete counter-current flow is created for highest possible efficiency. The corrugation of the plates provides the passage between the plates, supports each plate against the adjacent one and enhances the turbulence, resulting in efficient heat transfer.



T5-FG

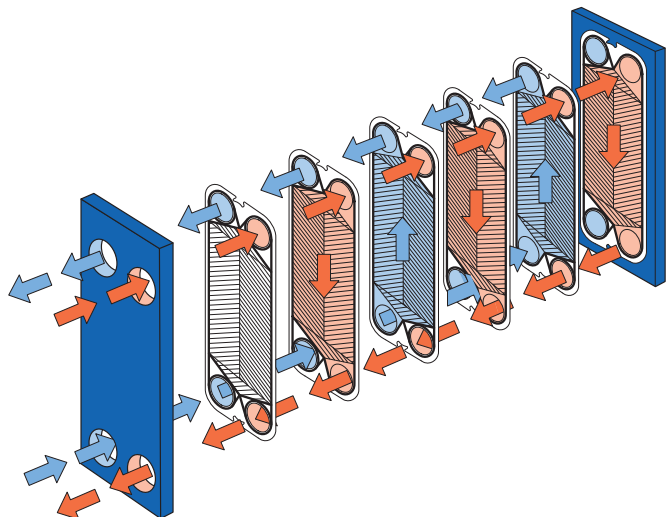

Flow principle of a plate heat exchanger

## STANDARD MATERIALS

### Frame plate

Mild steel, Epoxy painted

### Nozzles

Carbon steel

Pipe: Stainless steel, titanium

### Plates

Stainless steel Alloy 316 / Alloy 304

Titanium

### Gaskets

Nitrile, EPDM

## TECHNICAL DATA

Pressure vessel codes PED, ASME, pvcALS™

Mechanical design pressure (g) / temperature

FG	pvcALS™	1.6 MPa / 180°C
FG	PED	1.6 MPa / 160°C
FG	ASME	150 psig / 356°F

### Maximum heat transfer surface

T5-B	7.1 m <sup>2</sup> (76.4 sq.ft)
T5-M	4.4 m <sup>2</sup> (47.4 sq.ft)

### Connections

Straight threaded	Size 50 mm ISO G2"
Tapered threaded	Size 50 mm ISO R2", NPT2"
Threaded inlet port	Size 50 mm ISO-G2"

## Dimensions

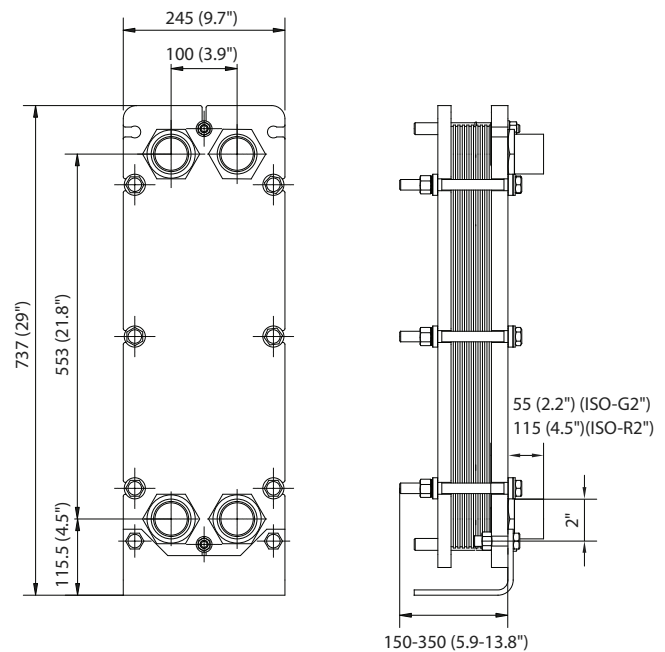

## Measurements mm (inch)

Type	H	W	h
T5-FG	737 (29.0")	245 (9.6")	115.5 (4.5")

## Particulars required for quotation

- Flow rates or heat load
- Temperature program
- Physical properties of liquids in question (if not water)
- Desired working pressure
- Maximum permitted pressure drop

### How to contact Alfa Laval

Up-to-date AlfaLaval contact details for all countries are always available on our website on [www.alfalaval.com](http://www.alfalaval.com)



# Alfa Laval M6

## Gasketed plate-and-frame heat exchanger

### Applications

General heating and cooling duties. Heating by means of steam.

### Standard design

The plate heat exchanger consists of a pack of corrugated metal plates with portholes for the passage of the two fluids between which heat transfer will take place.

The plate pack is assembled between a fix frame plate and a movable pressure plate and compressed by tightening bolts. The plates are fitted with a gasket which seals the interplate channel and directs the fluids into alternate channels. The number of plates is determined by the flow rate, physical properties of the fluids, pressure drop and temperature program. The plate corrugations promote fluid turbulence and support the plates against differential pressure.

The frame plate and the pressure plate are suspended from an upper carrying bar and located by a lower guiding bar, both of which are fixed to a support column.

Connections are located in the frame plate or, if either or both fluids make more than a single pass within the unit, in the frame and pressure plates.

### Typical capacities

#### Liquid flow rate

Up to 16 kg/s (250 gpm), depending on media, permitted pressure drop and temperature program.

#### Water heating by steam

300 to 800 kW

#### Plate types

M6, M6-M and M6-MD

#### Frame types

FM, FG and FD

### Working principle

Channels are formed between the plates and the corner ports are arranged so that the two media flow through alternate channels. The heat is transferred through the plate between the channels, and complete counter-current flow is created for highest possible efficiency. The corrugation of the plates provides the passage between the plates, supports each plate against the adjacent one and enhances the turbulence, resulting in efficient heat transfer.



M6-FG

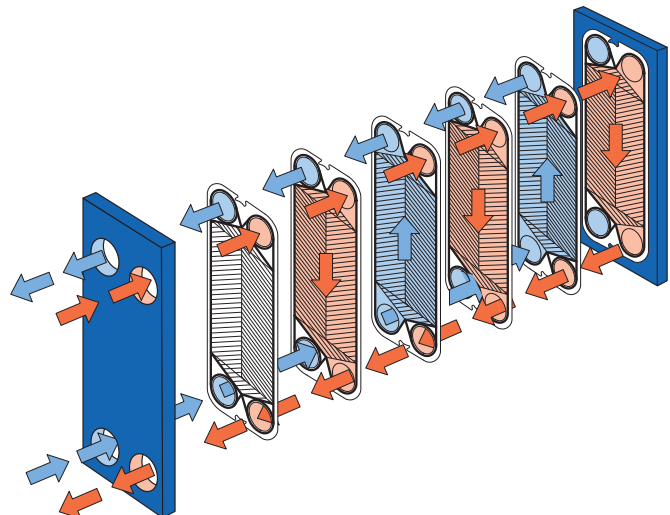

Flow principle of a plate heat exchanger



## STANDARD MATERIALS

### Frame plate

Mild steel, Epoxy painted

### Nozzles

Carbon steel

Metal lined: Stainless steel, Titanium, Alloy 254 SMO, Alloy C276

Rubber lined: Nitrile, EPDM

### Plates

Stainless steel: Alloy 316, Alloy 304. Alloy 254 SMO, Alloy C276, Titanium

### Gaskets

Nitrile, EPDM, Viton®

Other grades and material available on request.

## TECHNICAL DATA

### Pressure vessel codes, PED, ASME, pvcALS™

#### Mechanical design pressure (g) / temperature

FM	pvcALS™	1.0 MPa / 180°C
FG	PED	1.6 MPa / 180°C
FG	ASME	162 psig / 482°F
FG	pvcALS™	1.6 MPa / 180°C
FD	PED, pvcALS™	2.5 MPa / 180°C
FD	ASME	351 psig / 482°F

## Connections

### Pipe connections (not for frame type FD)

	Size:	
Straight threaded	50 mm	ISO G2"
Tapered threaded	50 mm	ISO R2", NPT2"
Straight weld	50 mm	
Threaded inlet port	50 mm	ISO G2"
Grooved pipe	50 mm	2"

### Flange connections

	Size:	
FM	pvcALS™	50 mm DIN/GB/GOST PN10, ASME Cl. 150, JIS 10K
FG	PED	50 mm DIN PN16, ASME Cl. 150
FG	ASME	2" ASME Cl. 150
FG	pvcALS™	50 mm DIN/GB/GOST PN16, ASME Cl. 150, JIS 16K
FD	PED	50 mm DIN PN25, ASME Cl. 300
FD	ASME	2" ASME Cl. 300
FD	ALS	50 mm DIN, GB, GOST PN25, JIS 20K

## Dimensions

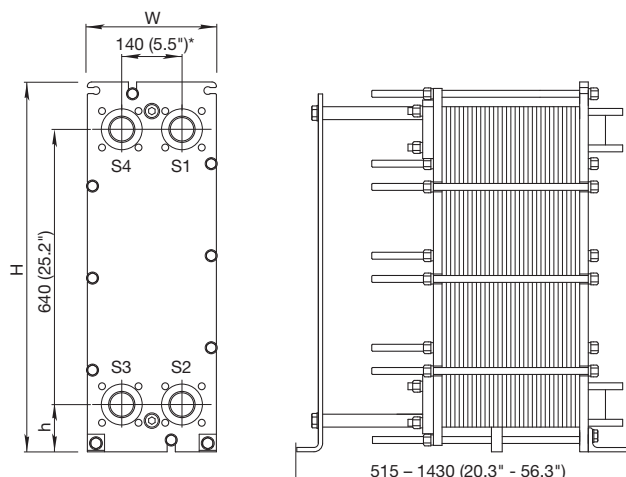

\* Displacement of some connection types occur.

### Measurements mm (inch)

Type	H	W	h
M6-FM	920 (36.2")	320 (12.6")	140 (5.5")
M6-FG	920 (36.2")	320 (12.6")	140 (5.5")
M6-FD	940 (37.0")	330 (13.0")	150 (5.9")

The number of tightening bolts may vary depending on pressure rating.

### Maximum heat transfer surface

38 m<sup>2</sup> (400 sq. ft)

### Particulars required for quotation

- Flow rates or heat load
- Temperature program
- Physical properties of liquids in question (if not water)
- Desired working pressure
- Maximum permitted pressure drop
- Available steam pressure

### How to contact Alfa Laval

Up-to-date AlfaLaval contact details for all countries are always available on our website on [www.alfalaval.com](http://www.alfalaval.com)



# Alfa Laval TL6

## Gasketed plate-and-frame heat exchanger

### Applications

General heating and cooling duties.

### Standard design

The plate heat exchanger consists of a pack of corrugated metal plates with portholes for the passage of the two fluids between which heat transfer will take place.

The plate pack is assembled between a fix frame plate and a movable pressure plate and compressed by tightening bolts. The plates are fitted with a gasket which seals the interplate channel and directs the fluids into alternate channels. The number of plates is determined by the flow rate, physical properties of the fluids, pressure drop and temperature program. The plate corrugations promote fluid turbulence and support the plates against differential pressure.

The plate and the pressure plate are suspended from an upper carrying bar and located by a lower guiding bar, both of which are fixed to a support column.

Connections are located in the frame plate or, if either or both fluids make more than a single pass within the unit, in the frame and pressure plates.

### Typical capacities

#### Liquid flow rate

Up to 20 kg/s (317 gpm), depending on media, permitted pressure drop and temperature program.

### Plate types

TL6-B

### Frame types

FM, FG and FD

### Working principle

Channels are formed between the plates and the corner ports are arranged so that the two media flow through alternate channels. The heat is transferred through the plate between the channels, and complete counter-current flow is created for highest possible efficiency. The corrugation of the plates provides the passage between the plates, supports each plate against the adjacent one and enhances the turbulence, resulting in efficient heat transfer.



TL6-FG

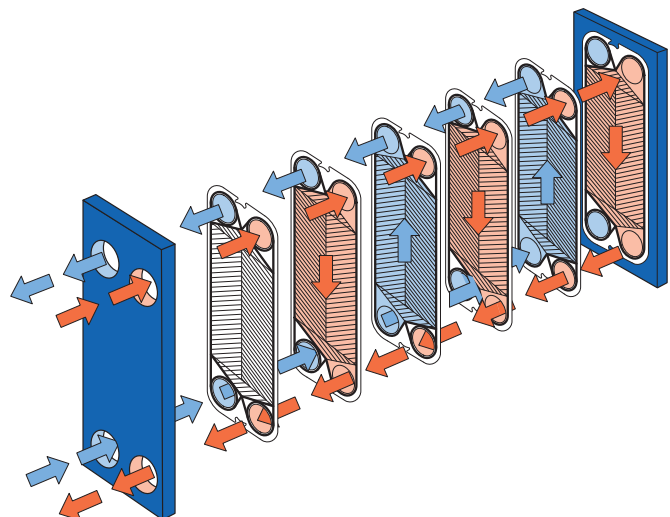

Flow principle of a plate heat exchanger

## STANDARD MATERIALS

### Frame plate

Mild steel, Epoxy painted

### Nozzles

Carbon steel

Metal lined: Stainless steel, Titanium

Rubber lined: Nitrile, EPDM

Pipe: Stainless steel

### Plates

Stainless steel Alloy 316 / Alloy 304, Titanium, Alloy 254 SMO, Alloy C276

### Gaskets

Nitrile, EPDM, Viton®

Other grades and material available on request

## TECHNICAL DATA

### Pressure vessel codes, PED, ASME, pvcALS™

### Mechanical design pressure (g) / temperature

FM	pvcALS™	1.0 MPa / 180°C
FM	PED	1.0 MPa / 180°C
FG	pvcALS™	1.6 MPa / 180°C
FG	PED	1.6 MPa / 180°C
FG	ASME	150 psig / 482°F
FD	pvcALS™	2.5 MPa / 180°C
FD	PED	2.5 MPa / 180°C
FD	ASME	300 psig / 482°F

## Connections

### Pipe connections (not for frame type FD)

Straight threaded	Size 50 mm	ISO G2", NPT 2"
Threaded inlet port	Size 50 mm	ISO G2"

### Flange connections

	Size:	
FM pvcALS™	50/65 mm	DIN/GB/GOST PN16, ASME Cl.150, JIS 10K
FM PED	50/65 mm	DIN PN16, ASME Cl. 150
FG pvcALS™	50/65 mm	DIN/GB/GOST PN16, ASME Cl. 150, JIS 10K, JIS 16K
FG PED	50/65 mm	DIN PN16, ASME Cl. 150
FG ASME	2-2½" in	ASME Cl.150
FD pvcALS™	50/65 mm	DIN/GB/GOST PN40, ASME Cl.300, JIS 20K
FD PED	50/65 mm	DIN PN40, ASME Cl. 300
FD ASME	2-2½" in	ASME Cl. 300

## Dimensions

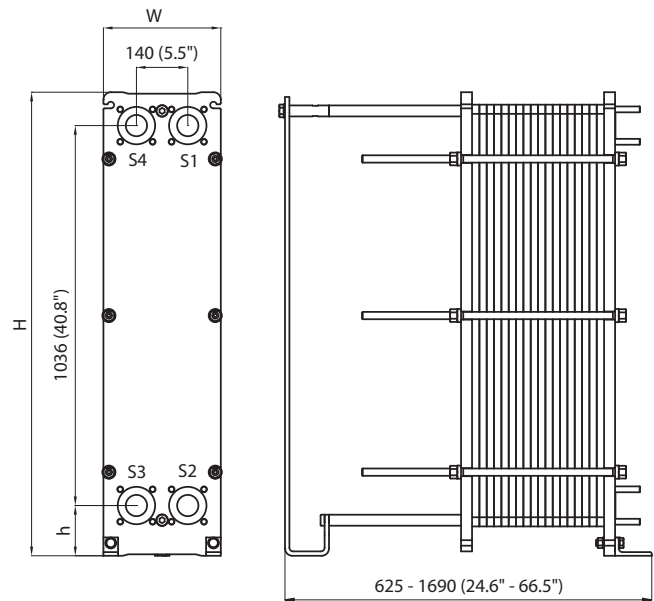

## Measurements mm (inch)

Type	H	W	h
TL6-FM / PED / pvcALS™	1264 (49.8")	320 (12.6")	137 (5.4")
TL6-FG / PED / pvcALS™	1264 (49.8")	320 (12.6")	137 (5.4")
TL6-FG / ASME	1299 (51.1")	320 (12.6")	142 (5.6")
TL6-FD / PED / pvcALS™	1264 (49.8")	330 (13.0")	137 (5.4")
TL6-FD / ASME	1308 (51.5")	330 (13.0")	142 (5.6")

The number of tightening bolts may vary depending on pressure rating.

## Maximum heat transfer surface

102.0 m<sup>2</sup> (1097 sq.ft)

## Particulars required for quotation

- Flow rates or heat load
- Temperature program
- Physical properties of liquids in question (if not water)
- Desired working pressure
- Maximum permitted pressure drop

## How to contact Alfa Laval

Up-to-date AlfaLaval contact details for all countries are always available on our website on [www.alfalaval.com](http://www.alfalaval.com)



# Alfa Laval TS6

## Gasketed plate-and-frame heat exchanger

### Applications

General heating and cooling duties. Heating by means of steam.

### Standard design

The plate heat exchanger consists of a pack of corrugated metal plates with portholes for the passage of the two fluids between which heat transfer will take place.

The plate pack is assembled between a fix frame plate and a movable pressure plate and compressed by tightening bolts. The plates are fitted with a gasket which seals the interplate channel and directs the fluids into alternate channels. The number of plates is determined by the flow rate, physical properties of the fluids, pressure drop and temperature program. The plate corrugations promote fluid turbulence and support the plates against differential pressure.

The plate and the pressure plate are suspended from an upper carrying bar and located by a lower guiding bar, both of which are fixed to a support column.

Connections are located in the frame plate or, an additional auxiliary connection for steam may be mounted on the pressure plate to handle high capacities.

### Typical capacities

#### Liquid flow rate

Up to 20 kg/s (300 gpm), depending on media, permitted pressure drop and temperature program.

#### Water heating by steam

200-1800 kW

#### Plate types

TS6-M

#### Frame types

FG and FD

### Working principle

Channels are formed between the plates and the corner ports are arranged so that the two media flow through alternate channels. The heat is transferred through the plate between the channels, and complete counter-current flow is created for highest possible efficiency. The corrugation of the plates provides the passage between the plates, supports each plate against the adjacent one and enhances the turbulence, resulting in efficient heat transfer.



TS6-MFG

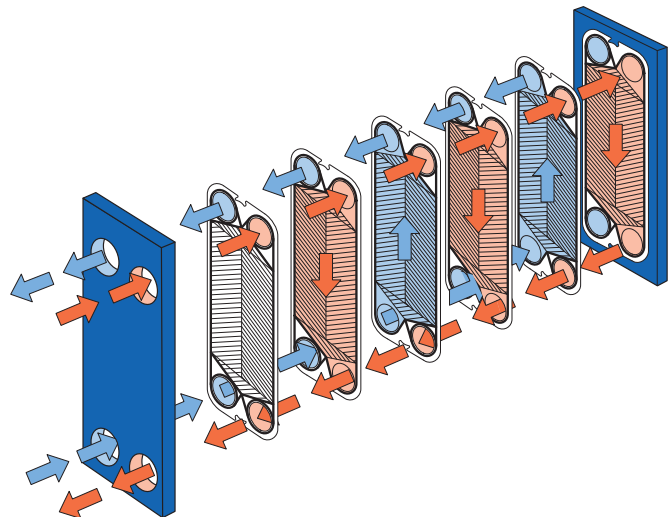

Flow principle of a plate heat exchanger



## STANDARD MATERIALS

### Frame plate

Mild steel, Epoxy painted

### Nozzles

Carbon steel

Metal lined: Stainless steel, Titanium

### Plates

Stainless steel Alloy 316, Titanium

### Gaskets

Nitrile, EPDM, Viton®

Other grades and material available on request.

## TECHNICAL DATA

### Pressure vessel codes, PED, ASME, pvcALS™

#### Mechanical design pressure (g) / temperature

FG	PED	1.6 MPa / 180°C *)
FG	pvcALS™	1.6 MPa / 180°C
FG	ASME	207 psig / 482°F
FD	PED	2.5 MPa / 180°C
FD	ASME	300 psig / 482°F

\*) Frame FG also approved for 1.2 MPa / 200°C to allow use in steam systems without safety valves.

### Connections

	Size:	
FG PED	DN65, NPS 3	DIN PN16, ASME Cl. 150
FG PV- cALS™	DN65, NPS 3, 65A	DIN/GB/GOST PN16, JIS 10 K, JIS 16 K
FG ASME	NPS 3	ASME Cl. 150
FD PED	DN65, NPS 2½	DIN PN25, ASME Cl. 300
FD PV- cALS™	DN65, NPS 2½, 65A	DIN/GB/GOST PN25, JIS 10 K, JIS 20 K
FD ASME	NPS 2½"	ASME Cl. 300

## Dimensions

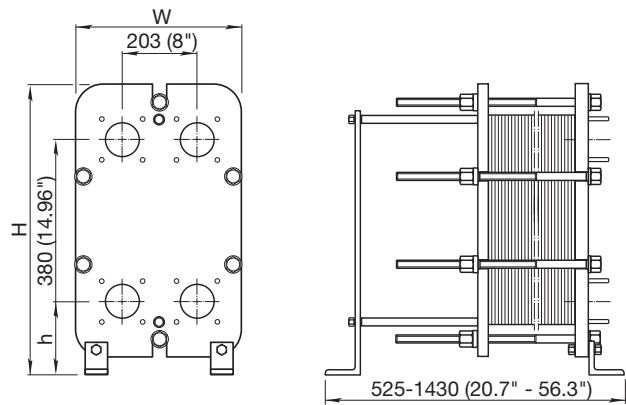

## Measurements mm (inch)

Type	H	W	h
TS6-FG	704 (27.7")	400 (15.7")	188 (7.4")
TS6-FD	704 (27.7")	410 (16.1")	188 (7.4")

The number of tightening bolts may vary depending on pressure rating.

## Maximum heat transfer surface

13 m<sup>2</sup> (140 sq. ft)

## Particulars required for quotation

- Flow rates or heat load
- Temperature program
- Physical properties of liquids in question (if not water)

### How to contact Alfa Laval

Up-to-date AlfaLaval contact details for all countries are always available on our website on [www.alfalaval.com](http://www.alfalaval.com)



# Alfa Laval T8

## Gasketed plate-and-frame heat exchanger

### Application

The Alfa Laval industrial line of plate heat exchangers is well suited for a wide range of heating and cooling duties.

### Benefits

- High serviceability - Easy to open
- Compact design
- Easy to install
- Flexible heat transfer area configuration
- High energy efficiency - Low operating cost

### Design

The plate heat exchanger consists of a package of corrugated metal plates with portholes for the passage of the two fluids between which heat transfer will take place.

The number of plates is determined by the flow rates, physical properties of the fluids, pressure drops and temperature program. The plate corrugations promote fluid turbulence and support the plates against differential pressure.

The materials of gaskets are selected for safe use depending on media type and temperature. The attachment of the gasket rings is glue-free, which makes them easy to replace even with the plates still hanging in the frame.

The carrying bar and guiding bar are fixed to the stationary frame plate and the supporting column. The pressure plate and plate package is movable along the upper carrying bar and located by the lower guiding bar. Connections are located in the frame plate. Depending on the application, connections can also be located in the pressure plate.



### Working principle

Channels are formed between the plates and the corner ports are arranged so that the two media flow through alternate channels. The heat is transferred through the plates between the channels. Complete counter-current or co-current flow, depending on the application, is created for highest possible efficiency. The corrugation of the plates provides the passage between the plates, supports each plate against the adjacent one and enhances the turbulence, resulting in efficient heat transfer.

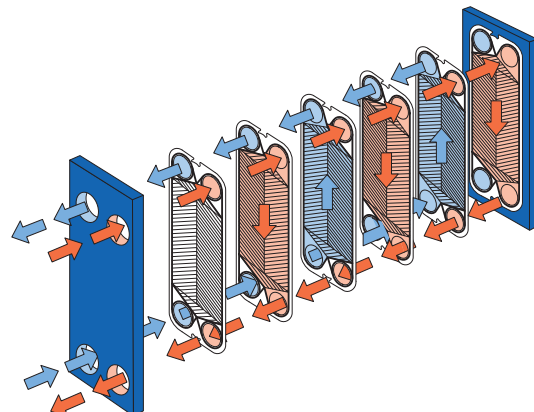

Flow principle of a plate heat exchanger.

## STANDARD MATERIALS

### Frame plate

Mild steel, epoxy painted

### Connections

Metal lined: Stainless steel and Titanium.

Rubber lined: Nitrile (FM only)

### Plates

Stainless steel Alloy 304, Alloy 316 and Titanium

### Gaskets

Field gaskets: Nitrile, EPDM

Ring gaskets: Nitrile, EPDM

Other grades and materials available upon request.

## TECHNICAL DATA

### Design pressure (g)

FM	pvcALS™	1.034 MPa
FM	PED	1.034 MPa
FG	pvcALS™	1.60 MPa
FG	PED	1.60 MPa
FG	ASME	150 psi

### Design temperature

Determined by gasket material.

### Plate types

T8-B and T8-M

### Connection size

DN80 / NPS 3 / 80A

### Maximum heat transfer surface

35 m<sup>2</sup> (377 sqft)

### Maximum liquid flow rates

Up to 30 kg/s (475 gpm), depending on media, permitted pressure drop and temperature program.

## Connection standard

FM	pvcALS™	EN 1092-1 PN10, ASME B16.5 Class 150, JIS B2220 10K
FM	PED	EN 1092-1 PN10, ASME B16.5 Class 150
FG	pvcALS™	EN 1092-1 PN16 and PN10, ASME B16.5 Class 150, JIS B2220 16K and 10K
FG	PED	EN 1092-1 PN16, ASME B16.5 Class 150
FG	ASME	ASME B16.5 Class 150

Standard EN 1092-1 corresponds to GOST 12815-80 and GB/T 9115.

## Particulars required for quotation

To receive a quotation for plate heat exchangers that meet your requirements, please provide Alfa Laval representatives with:

- Flow rates or heat load
- Temperature program
- Physical properties of liquids in question (if not water)
- Design pressure and design temperature
- Maximum permitted pressure drop

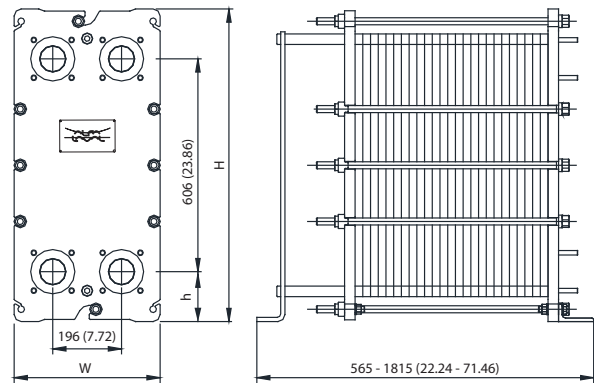

## Measurements mm (inch)

Type	H	W	h
T8-FM (ALS,PED,ASME)	890 (35.04)	400 (15.78)	142 (5.59)
T8-FG (ALS,PED)	890 (35.04)	400 (15.78)	142 (5.59)
T8-FG (ASME)	890 (35.04)	416 (16.38)	142 (5.59)

The number of tightening bolts may vary depending on type.

### How to contact Alfa Laval

Up-to-date AlfaLaval contact details for all countries are always available on our website on [www.alfalaval.com](http://www.alfalaval.com)



# Alfa Laval M10

## Gasketed plate-and-frame heat exchanger

### Applications

General heating and cooling duties. Heating by means of steam.

### Standard design

The plate heat exchanger consists of a pack of corrugated metal plates with portholes for the passage of the two fluids between which heat transfer will take place.

The plate pack is assembled between a fix frame plate and a movable pressure plate and compressed by tightening bolts. The plates are fitted with a gasket which seals the interplate channel and directs the fluids into alternate channels. The number of plates is determined by the flow rate, physical properties of the fluids, pressure drop and temperature program. The plate corrugations promote fluid turbulence and support the plates against differential pressure.

The plate and the pressure plate are suspended from an upper carrying bar and located by a lower guiding bar, both of which are fixed to a support column.

Connections are located in the frame plate or, if either or both fluids make more than a single pass within the unit, in the frame and pressure plates.

### Typical capacities

#### Liquid flow rate

Up to 50 kg/s (800 gpm), depending on media, permitted pressure drop and temperature program.

#### Water heating by steam

0.7 to 3.0 MW

#### Plate types

M10-B, M10-M and M10-BD, double wall plates.

#### Frame types

FM, FG and FD

### Working principle

Channels are formed between the plates and the corner ports are arranged so that the two media flow through alternate channels. The heat is transferred through the plate between the channels, and complete counter-current flow is created for highest possible efficiency. The corrugation of the plates provides the passage between the plates, supports each plate against the adjacent one and enhances the turbulence, resulting in efficient heat transfer.

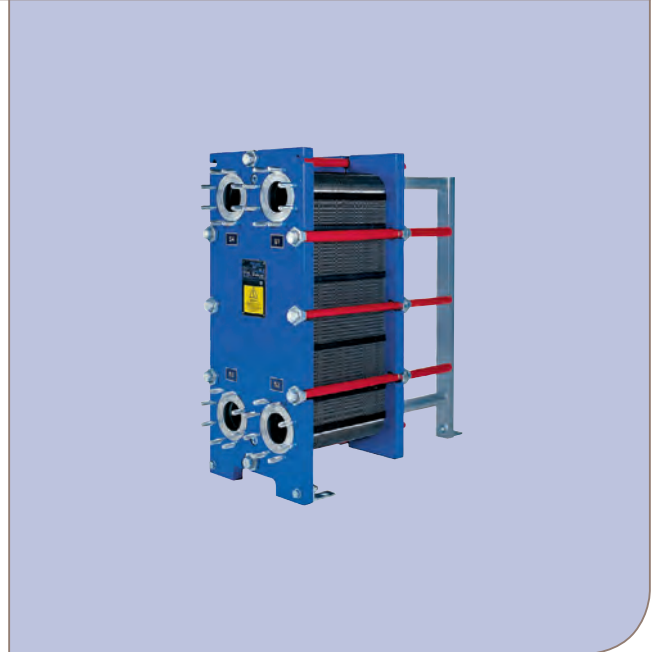

M10-BFG

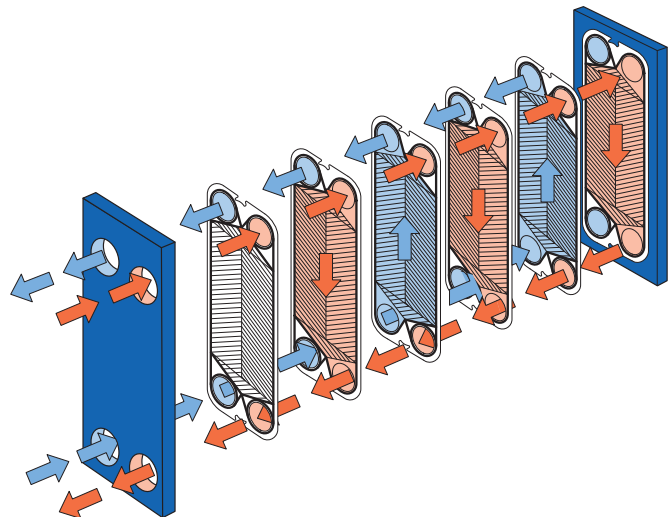

Flow principle of a plate heat exchanger



## STANDARD MATERIALS

### Frame plate

Mild steel, Epoxy painted

### Nozzles

Carbon steel

Metal lined: Stainless steel, Titanium

Rubber lined: Nitrile, EPDM

### Plates

Stainless steel Alloy 316/Alloy 304, Titanium, Alloy 254 SMO, Alloy C276

### Gaskets (Clip-on, glued)

Nitrile, EPDM, Viton®

Other grades and material available on request.

## TECHNICAL DATA

### Pressure vessel codes, PED, ASME, pvcALS™

#### Mechanical design pressure (g) / temperature

FL pvcALS™	0.6 MPa / 130°C
FM pvcALS™	1.0 MPa / 180°C
FM PED	1.0 MPa / 180°C
FG pvcALS™	1.6 MPa / 180°C
FG PED	1.6 MPa / 180°C *
FG ASME	150 psig / 356°F
FD PED pvcALS™	2.5 MPa / 180°C
FD ASME	389 psig / 482°F

\*) Frame FG also approved for 1.2 MPa / 200°C to allow use in steam systems without safety valves.

### Connections

Size: DN100 / NPS 4 / 100A

FL	pvcALS™	EN 1092-1 PN10, JIS B2220 10K
FM	pvcALS™	EN 1092-1 PN10, ASME B16.5 Class 150, JIS B2220 10K,
FM	PED	EN 1092-1 PN10, ASME B16.5 Class 150
FG	pvcALS™	EN 1092-1 PN16, ASME B16.5 Class 150, JIS B2220 10K, JIS B2220 16K,
FG	PED	EN 1092-1 PN16, ASME B16.5 Class 150
FG	ASME	ASME B16.5 Class 150
FD	PED	EN 1092-1 PN25, ASME B16.5 Class 150, ASME B16.5 Class 300
FD	ASME	ASME B16.5 Class 300

Standard EN 1092-1 corresponds to GOST 12815-80 and GB/T 9115.

## Dimensions

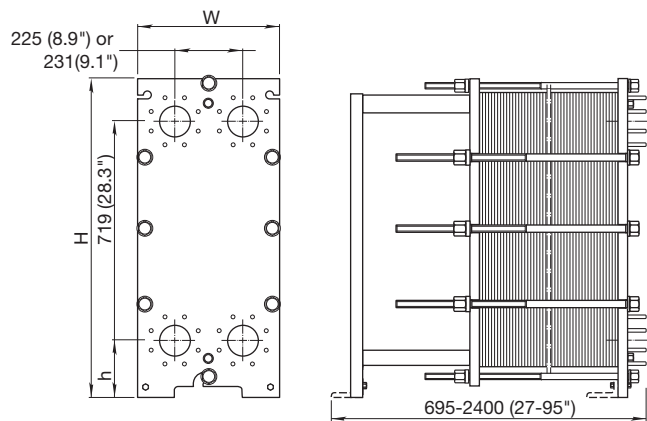

### Measurements mm (inch)

Type	H	W	h
M10-FM	1084 (42.7")	470 (18.5")	215 (8.5")
M10-FG	1084 (42.7")	470 (18.5")	215 (8.5")
M10-FD	981 (38.6")	470 (18.5")	131 (5.2")
M10-FD ASME	1084 (42.7")	470 (18.5")	215 (8.5")

The number of tightening bolts may vary depending on pressure rating.

### Maximum heat transfer surface

M10-B 90 m<sup>2</sup> (970 sq. ft)

M10-M 60 m<sup>2</sup> (650 sq. ft)

### Particulars required for quotation

- Flow rates or heat load
- Temperature program
- Physical properties of liquids in question (if not water)
- Desired working pressure
- Maximum permitted pressure drop
- Available steam pressure

### How to contact Alfa Laval

Up-to-date AlfaLaval contact details for all countries are always available on our website on [www.alfalaval.com](http://www.alfalaval.com)



# Alfa Laval TL10

## Gasketed plate-and-frame heat exchanger

### Applications

General heating and cooling duties.

### Standard design

The plate heat exchanger consists of a pack of corrugated metal plates with portholes for the passage of the two fluids between which heat transfer will take place.

The plate pack is assembled between a fix frame plate and a movable pressure plate and compressed by tightening bolts. The plates are fitted with a gasket which seals the interplate channel and directs the fluids into alternate channels. The number of plates is determined by the flow rate, physical properties of the fluids, pressure drop and temperature program. The plate corrugations promote fluid turbulence and support the plates against differential pressure.

The plate and the pressure plate are suspended from an upper carrying bar and located by a lower guiding bar, both of which are fixed to a support column.

Connections are located in the frame plate or, if either or both fluids make more than a single pass within the unit, in the frame and pressure plates.

### Typical capacities

#### Liquid flow rate

Up to 50 kg/s (800 gpm), depending on media, permitted pressure drop and temperature program.

#### Plate types

TL10-B, TL10-P

#### Frame types

FM, FG and FS

### Working principle

Channels are formed between the plates and the corner ports are arranged so that the two media flow through alternate channels. The heat is transferred through the plate between the channels, and complete counter-current flow is created for highest possible efficiency. The corrugation of the plates provides the passage between the plates, supports each plate against the adjacent one and enhances the turbulence, resulting in efficient heat transfer.

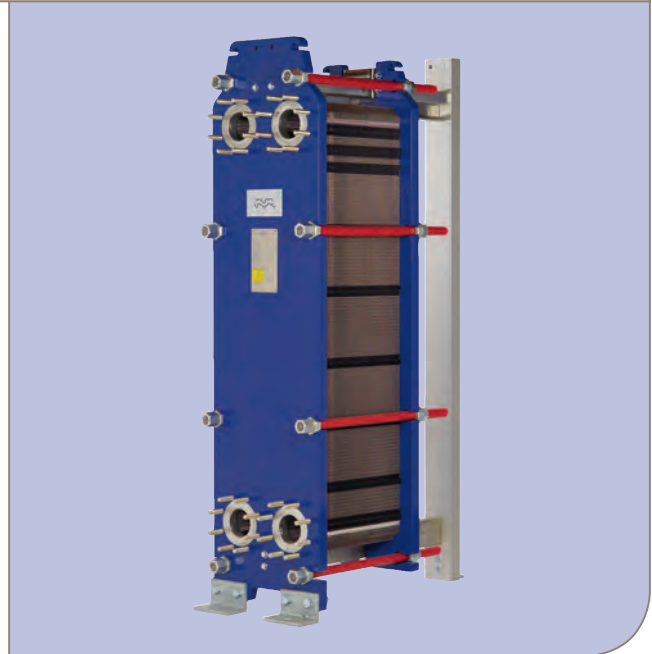

TL10-BFG

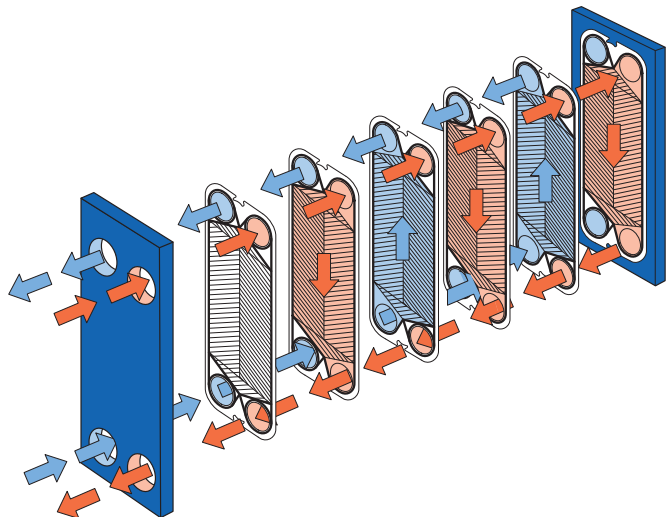

Flow principle of a plate heat exchanger

## STANDARD MATERIALS

### Frame plate

Mild steel, Epoxy painted

### Nozzles

Carbon steel

Metal lined: Stainless steel, Titanium, Alloy 254, Alloy C276, Nickel

Rubber lined: Nitrile, EPDM

### Plates

Stainless steel: Alloy 304, Alloy 316, Alloy 254, Alloy C276  
Nickel, Titanium

### Gaskets

Nitrile, EPDM, Viton®

Other grades and material available on request

## TECHNICAL DATA

### Pressure vessel codes, PED, ASME, pvcALS™

### Mechanical design pressure (g) / temperature

FM	pvcALS™	1.0 MPa / 180°C
FG	PED, pvcALS™	1.6 MPa / 180°C
FG	ASME	150 psig / 482°F
FD	PED	2.5 MPa / 180°C
FS	ASME	400 psig / 482°F

### Connections

Size: DN100 / NPS 4 / 100A

FM	pvcALS™	EN 1092-1 PN10, ASME B16.5 Class 150, JIS B2220 10K
FG	PED	EN 1092-1 PN10, ASME B16.5 Class 150
FG	pvcALS™	EN 1092-1 PN16, ASME B16.5 Class 150, JIS B2220 16K
FG	ASME	ASME B16.5 Class 150
FD	PED	EN 1092-1 PN25, ASME B16.5 Class 300, Special square flange
FD	pvcALS™	EN 1092-1 PN25, ASME B16.5 Class 150, JIS B2220 20K
FS	ASME	Special square flange

Standard EN 1092-1 corresponds to GOST 12815-80 and GB/T 9115.

### Maximum heat transfer surface

250 m<sup>2</sup> (2700 sq. ft)

## Dimensions

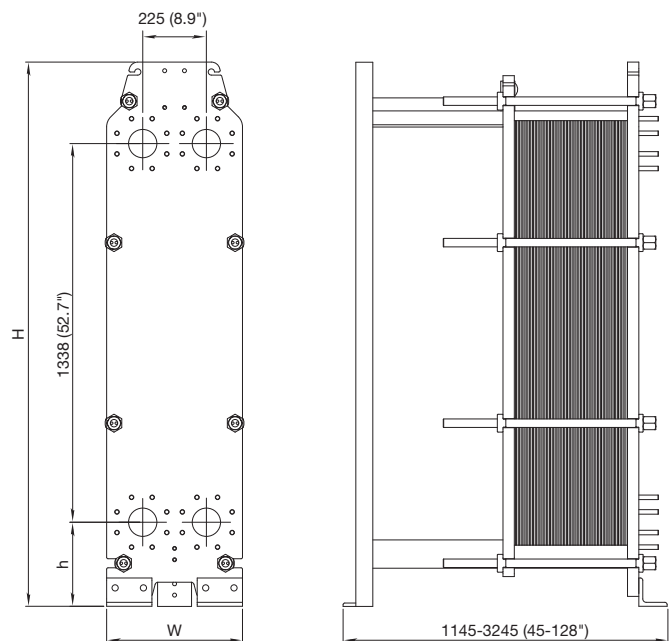

### Measurements mm (inch)

Type	H	W	h
TL10-FM	1885 (74.2")	480 (18.9")	255 (10")
TL10-FG	1981 (78")	480 (18.9")	297 (11.7")
TL10-FD	1981 (78")	480 (18.9")	297 (11.7")
TL10-FS	1981 (78")	510 (20.1")	297 (11.7")

The number of tightening bolts may vary depending on pressure rating.

### Particulars required for quotation

- Flow rates or heat load
- Temperature program
- Physical properties of liquids in question (if not water)
- Desired working pressure
- Maximum permitted pressure drop

### How to contact Alfa Laval

Up-to-date AlfaLaval contact details for all countries are always available on our website on [www.alfalaval.com](http://www.alfalaval.com)



# Alfa Laval M15

## Gasketed plate-and-frame heat exchanger

### Applications

General heating and cooling duties.

### Standard design

The plate heat exchanger consists of a pack of corrugated metal plates with portholes for the passage of the two fluids between which heat transfer will take place.

The plate pack is assembled between a fix frame plate and a movable pressure plate and compressed by tightening bolts. The plates are fitted with a gasket which seals the interplate channel and directs the fluids into alternate channels. The number of plates is determined by the flow rate, physical properties of the fluids, pressure drop and temperature program. The plate corrugations promote fluid turbulence and support the plates against differential pressure.

The plate and the pressure plate are suspended from an upper carrying bar and located by a lower guiding bar, both of which are fixed to a support column.

Connections are located in the frame plate or, if either or both fluids make more than a single pass within the unit, in the frame and pressure plates.

### Typical capacities

#### Liquid flow rate

Up to 80 kg/s (1300 gpm), depending on media, permitted pressure drop and temperature program.

#### Plate Types

M15-B, M15-M and M15-BD, double wall plates

#### Frame types

FL, FM, FG and FD

### Working principle

Channels are formed between the plates and the corner ports are arranged so that the two media flow through alternate channels. The heat is transferred through the plate between the channels, and complete counter-current flow is created for highest possible efficiency. The corrugation of the plates provides the passage between the plates, supports each plate against the adjacent one and enhances the turbulence, resulting in efficient heat transfer.



M15-BFM

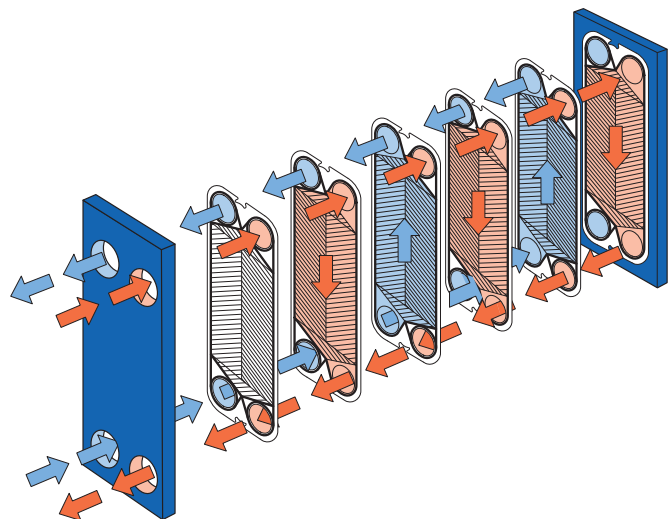

Flow principle of a plate heat exchanger



## STANDARD MATERIALS

### Frame plate

Mild steel, Epoxy painted

### Nozzles

Carbon steel

Metal lined: Stainless steel, Titanium

Rubber lined: Nitrile, EPDM

### Plates

Stainless steel: Alloy 304, Alloy 316, Alloy C276, Alloy 254 SMO, Titanium

### Gaskets (Clip-on/tape-on, glued)

Nitrile, EPDM, Viton®

Other grades and material available on request.

## TECHNICAL DATA

### Pressure vessel codes, PED, ASME, pvcALS™

#### Mechanical design pressure (g) / temperature

FL	pvcALS™	0.6 MPa / 130°C
FM	PED, pvcALS™	1.0 MPa / 180°C
FG	PED, pvcALS™	1.6 MPa / 180°C
FG	ASME	170 psig / 482°F
FD	PED, pvcALS™	3.0 MPa / 180°C
FD	ASME	300 psig / 356°F

## Connections

Size: DN150 / NPS 6 / 150A

FL	pvcALS™	EN 1092-1 PN10, JIS B2220 10K
FM	PED	DIN PN10, ASME B16.5 Class 150
FM	pvcALS™	DIN PN10, ASME B16.5 Class 150, JIS B2220 10K
FG	PED	DIN PN16, ASME B16.5 Class 150
FG	pvcALS™	DIN PN16, ASME B16.5 Class 150, JIS B2220 16K
FG	ASME	ASME B16.5 Class 150
FD	PED	DIN PN25, ASME B16.5 Class 300
FD	ASME	ASME B16.5 Class 300

Standard EN 1092-1 corresponds to GOST 12815-80 and GB/T 9115.

## Maximum heat transfer surface

390 m<sup>2</sup> (4200 sq. ft)

## Dimensions

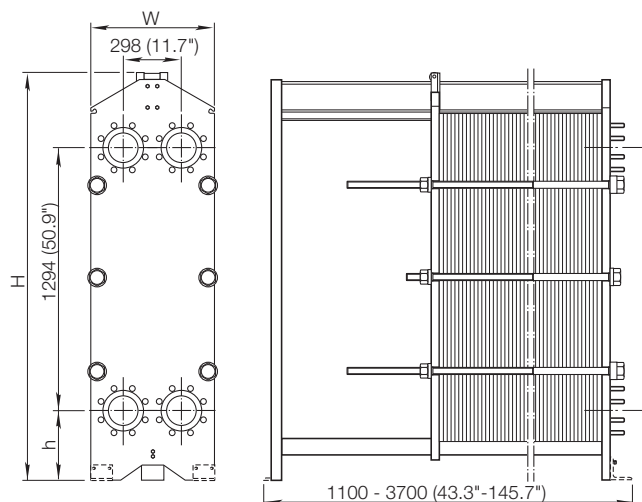

## Measurements mm (inch)

Type	H	W	h
M15-FL	1815 (71.5")	610 (24")	275 (10.8")
M15-FM	max. 1941 (76.4")	610 (24")	275 (10.8")
M15-FG	max. 1941 (76.4")	650 (25.6")	275 (10.8")
M15-FD	max. 2036 (80.2")	650 (25.6")	370 (14.6")

The number of tightening bolts may vary depending on pressure rating.

## Particulars required for quotation

- Flow rates or heat load
- Temperature program
- Physical properties of liquids in question (if not water)
- Desired working pressure
- Maximum permitted pressure drop
- Available steam pressure

## How to contact Alfa Laval

Up-to-date AlfaLaval contact details for all countries are always available on our website on [www.alfalaval.com](http://www.alfalaval.com)



# Alfa Laval TL15

## Gasketed plate-and-frame heat exchanger

### Applications

General heating and cooling duties.

### Standard design

The plate heat exchanger consists of a pack of corrugated metal plates with portholes for the passage of the two fluids between which heat transfer will take place.

The plate pack is assembled between a fix frame plate and a movable pressure plate and compressed by tightening bolts. The plates are fitted with a gasket which seals the interplate channel and directs the fluids into alternate channels. The number of plates is determined by the flow rate, physical properties of the fluids, pressure drop and temperature program. The plate corrugations promote fluid turbulence and support the plates against differential pressure.

The plate and the pressure plate are suspended from an upper carrying bar and located by a lower guiding bar, both of which are fixed to a support column.

Connections are located in the frame plate or, if either or both fluids make more than a single pass within the unit, in the frame and pressure plates.

### Typical capacities

#### Liquid flow rate

Up to 120 kg/s (1900 gpm), depending on media, permitted pressure drop and temperature program.

#### Plate types

TL15-B

#### Frame types

FM, FG, FD and FS

### Working principle

Channels are formed between the plates and the corner ports are arranged so that the two media flow through alternate channels. The heat is transferred through the plate between the channels, and complete counter-current flow is created for highest possible efficiency. The corrugation of the plates provides the passage between the plates, supports each plate against the adjacent one and enhances the turbulence, resulting in efficient heat transfer.

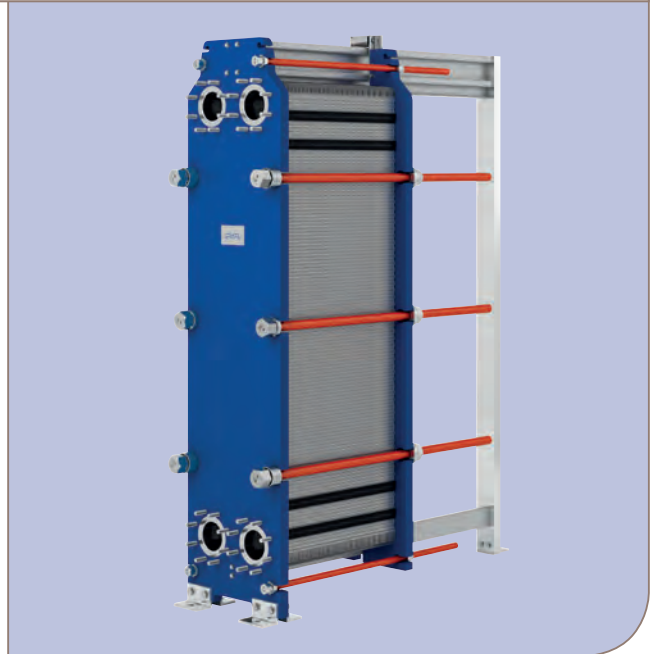

TL15-FG

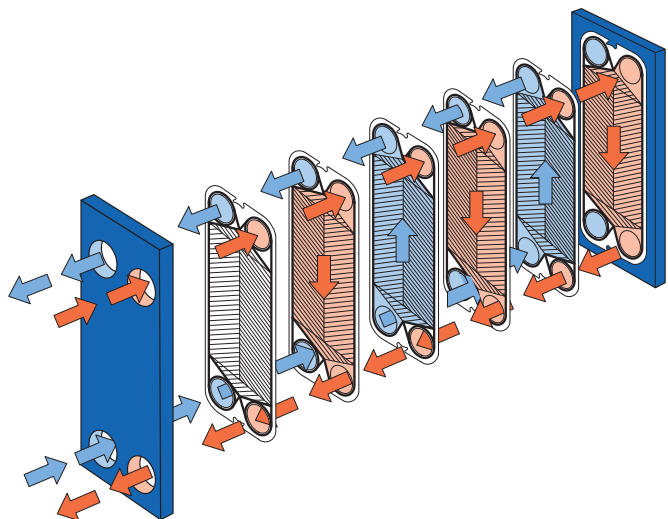

Flow principle of a plate heat exchanger

## STANDARD MATERIALS

### Frame plate

Mild steel, Epoxy painted

### Nozzles

Carbon steel

Metal lined: Stainless steel, Titanium

Rubber lined: Nitrile, EPDM

### Plates

Stainless steel: Alloy 304, Alloy 316. Titanium

### Gaskets

Nitrile, EPDM

## TECHNICAL DATA

Pressure vessel codes, PED, ASME, pvcALS™

Mechanical design pressure (g) / temperature\*

FM	pvcALS™	1.0 MPa / 180°C
FG	pvcALS™	2.0 MPa / 50°C
FG	PED	2.0 MPa / 50°C
FG	ASME	150 psig / 482°F
FD	ASME	300 psig / 482°F
FS	pvcALS™	3.5 MPa / 50°C
FS	PED	3.5 MPa / 50°C
FS	ASME	460 psig / 482°F

\* All PED and ALS units, except FM, are optimised for a design temperature of 50°C (122°F).

All PED and ALS units are also available for of multi range temperatures 50, 100, 150, 180 and 200°C with corresponding lower design pressure.

## Connections

Size: DN150 / NPS 6 / 150A

FM	pvcALS™	EN 1092-1 PN10, ASME B16.5 Class 150, JIS B2220 10K
FG	pvcALS™	DIN/GB/GOST PN16, PN25, ASME Cl. 150, JIS 10K, JIS 16K
FG	PED	EN 1092-1 PN16, EN 1092-1 PN25, ASME B16.5 Class 150
FG	ASME	ASME B16.5 Class 150
FD	ASME	ASME B16.5 Class 300
FS	pvcALS™	EN 1092-1 PN25, EN 1092-1 PN40, ASME B16.5 Class 300 JIS 10K, JIS 20K
FS	PED	EN 1092-1 PN25, EN 1092-1 PN40, ASME B16.5 Class 300
FS	ASME	ASME B16.5 Class 300

Standard EN 1092-1 corresponds to GOST 12815-80 and GB/T 9115.

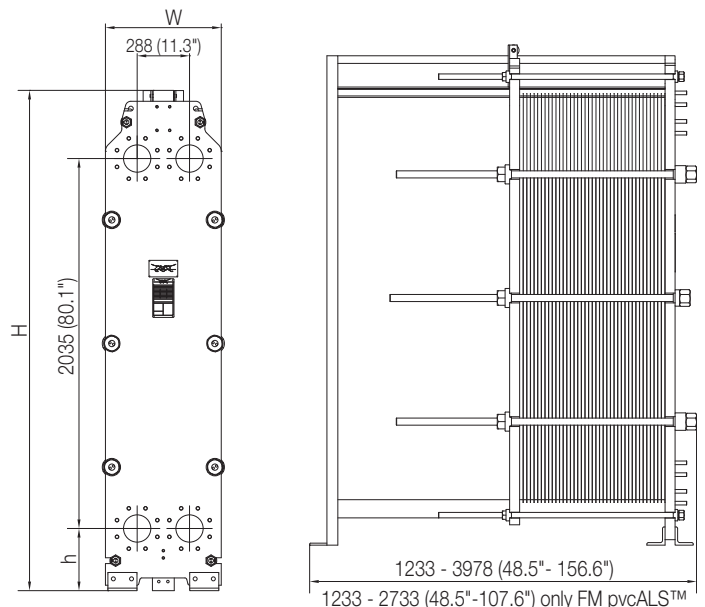

## Measurements mm (inch)

Type	H	W	h
TL15-FM/pvcALS™	2752 (108.3")	610 (24.0")	342 (13.5")
TL15-FG/PED/pvcALS™	2752 (108.3")	637 (25.1")	342 (13.5")
TL15-FG/ASME	2752 (108.3")	646 (25.4")	342 (13.5")
TL15-FD/ASME	2752 (108.3")	646 (25.4")	342 (13.5")
TL15-FS/PED/pvcALS™	2752 (108.3")	646 (25.4")	342 (13.5")
TL15-FS/ASME	2752 (108.3")	646 (25.4")	342 (13.5")

The number of tightening bolts may vary depending on pressure rating and Pressure Vessel Code (PVC) requirements.

## Maximum heat transfer surface

990 (1.1 x 900) m<sup>2</sup> (10660 sq.ft)

## Particulars required for quotation

- Flow rates or heat load
- Temperature program
- Physical properties of liquids in question (if not water)
- Desired working pressure
- Maximum permitted pressure drop
- Available steam pressure

## How to contact Alfa Laval

Up-to-date AlfaLaval contact details for all countries are always available on our website on [www.alfalaval.com](http://www.alfalaval.com)



# Alfa Laval TS20

## Gasketed plate-and-frame heat exchanger

### Applications

General heating and cooling duties. Heating by means of steam.

### Standard design

The plate heat exchanger consists of a pack of corrugated metal plates with portholes for the passage of the two fluids between which heat transfer will take place.

The plate pack is assembled between a fix frame plate and a movable pressure plate and compressed by tightening bolts. The plates are fitted with a gasket which seals the interplate channel and directs the fluids into alternate channels. The number of plates is determined by the flow rate, physical properties of the fluids, pressure drop and temperature program. The plate corrugations promote fluid turbulence and support the plates against differential pressure.

The plate and the pressure plate are suspended from an upper carrying bar and located by a lower guiding bar, both of which are fixed to a support column.

Connections are located in the frame plate or, if either or both fluids make more than a single pass within the unit, in the frame and pressure plates.

### Typical capacities

#### Liquid flow rate

Up to 190 kg/s (3040 gpm), depending on media, permitted pressure drop and temperature program.

#### Water heating by steam

2.5-15 MW at a steam condensation temperature of 150°C  
2.5-9 MW at a steam condensation temperature of 120°C

#### Plate types

TS20-M plates

#### Frame types

FM, FG and FS

### Working principle

Channels are formed between the plates and the corner ports are arranged so that the two media flow through alternate channels. The heat is transferred through the plate between the channels, and complete counter-current flow is created for highest possible efficiency. The corrugation of the plates provides the passage between the plates, supports each plate against the adjacent one and enhances the turbulence, resulting in efficient heat transfer.



TS20-MFG

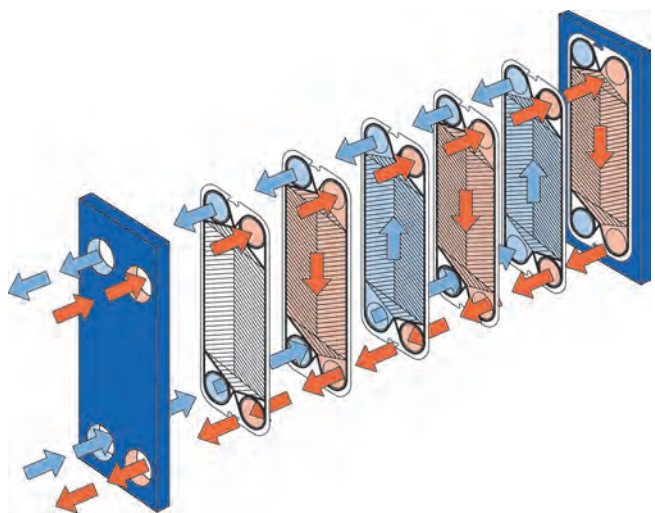



## STANDARD MATERIALS

### Frame plate

Mild steel, Epoxy painted

### Nozzles

Carbon steel

Metal lined: Stainless steel, Titanium, Alloy C-276

Rubber lined: Nitrile, EPDM

### Plates

Stainless steel Alloy 316 (Alloy 254, Alloy C-276 or Titanium

Other grades and material available on request.

### Gaskets

Nitrile, EPDM, Viton or HeatSealF™

Other grades and material available on request.

## TECHNICAL DATA

### Pressure vessel codes, PED, ASME, pvcALS™

#### Mechanical design pressure (g) / temperature

FM	PED	10 MPa / 210°C
FM	pvcALS™	1.0 MPa / 180°C
FG	PED	1.6 MPa / 180°C *)
FG	ASME	150 psig / 350°F
FG	pvcALS™	1.6 MPa / 180°C
FS	PED	3.0 MPa / 160°C
FS	ASME	460 psig / 350°F

\*) Frame FG also approved for 1.2 MPa / 200°C to allow use in steam systems without safety valves.

### Connections

Size: DN200 / NPS 8 / 200A

FM	PED	EN 1092-1 PN10, ASME B16.5 Class 150
FM	pvcALS™	EN 1092-1 PN10, ASME B16.5 Class 150, JIS B2220 10K
FG	PED	EN 1092-1 PN16, ASME B16.5 Class 150
FG	ASME	ASME B16.5 Class 150
FG	pvcALS™	EN 1092-1 PN10, ASME B16.5 Class 150, JIS B2220 10K, JIS B2220 16K
FS	PED	EN 1092-1 PN25, EN 1092-1 PN40, ASME Cl. 300
FS	ASME	ASME B16.5 Class 150, ASME B16.5 Class 300

Standard EN 1092-1 corresponds to GOST 12815-80 and GB/T 9115.

## Dimensions

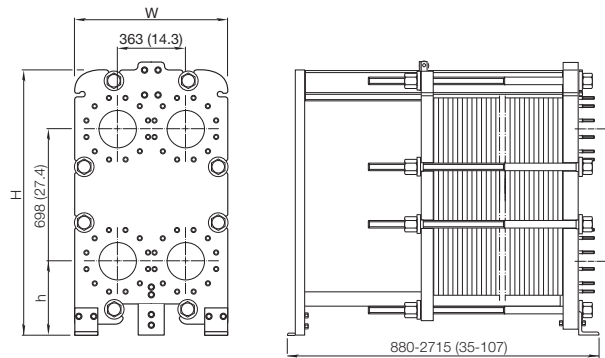

## Measurements mm (inch)

Type	H	W	h
TS20-MFM	1405 (55 <sup>5</sup> / <sub>16</sub> )	740 (29 <sup>1</sup> / <sub>8</sub> )	360 (14 <sup>1</sup> / <sub>8</sub> )
TS20-MFG	1405 (55 <sup>5</sup> / <sub>16</sub> )	800 (31 <sup>1</sup> / <sub>2</sub> )	360 (14 <sup>1</sup> / <sub>8</sub> )
TS20-MFS	1435 (56 <sup>1</sup> / <sub>2</sub> )	800 (31 <sup>1</sup> / <sub>2</sub> )	390 (14 <sup>3</sup> / <sub>8</sub> )

The number of tightening bolts may vary depending on pressure rating.

### Maximum heat transfer surface

85 m<sup>2</sup> (910 sq. ft)

### Particulars required for quotation

- Flow rates or heat load
- Temperature program
- Physical properties of liquids in question (if not water)
- Desired working pressure
- Maximum permitted pressure drop
- Available steam pressure

### How to contact Alfa Laval

Up-to-date AlfaLaval contact details for all countries are always available on our website on [www.alfalaval.com](http://www.alfalaval.com)



# Alfa Laval T20

## Gasketed plate-and-frame heat exchanger

### Applications

General heating and cooling duties

### Standard design

The plate heat exchanger consists of a pack of corrugated metal plates with portholes for the passage of the two fluids between which heat transfer will take place.

The plate pack is assembled between a fix frame plate and a movable pressure plate and compressed by tightening bolts. The plates are fitted with a gasket, which seals the interplate channel and directs the fluids into alternate channels. The number of plates is determined by the flow rate, physical properties of the fluids, pressure drop and temperature program. The plate corrugations promote fluid turbulence and support the plates against differential pressure.

The frame plate and the pressure plate are suspended from an upper carrying bar and located by a lower guiding bar, both of which are fixed to a support column.

Connections are located in the frame plate or, if either or both fluids make more than a single pass within the unit, in the frame and pressure plates.

### Typical capacities

#### Liquid flow rate

Up to 225 kg/s (3600 gpm), depending on media, permitted pressure drop and temperature program.

#### Plate types

T20-P, T20-B and T20-M plates

#### Frame types

FM, FG and FS

### Working principle

Channels are formed between the plates and the corner ports are arranged so that the two media flow through alternate channels. The heat is transferred through the plate between the channels, and complete counter-current flow is created for highest possible efficiency. The corrugation of the plates provides the passage between the plates, supports each plate against the adjacent one and enhances the turbulence, resulting in efficient heat transfer.

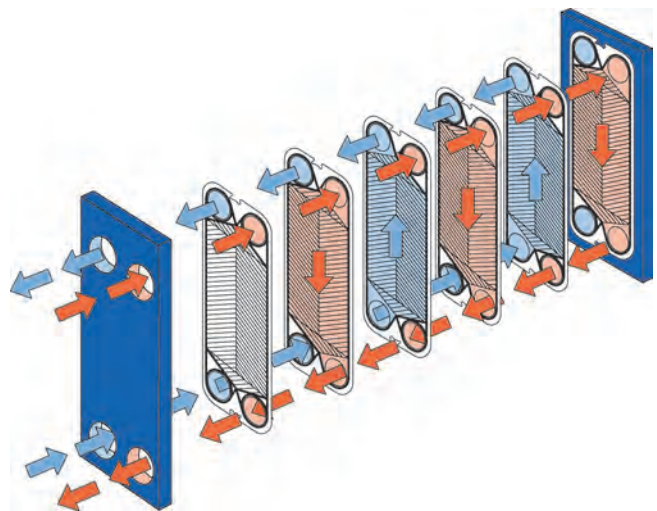
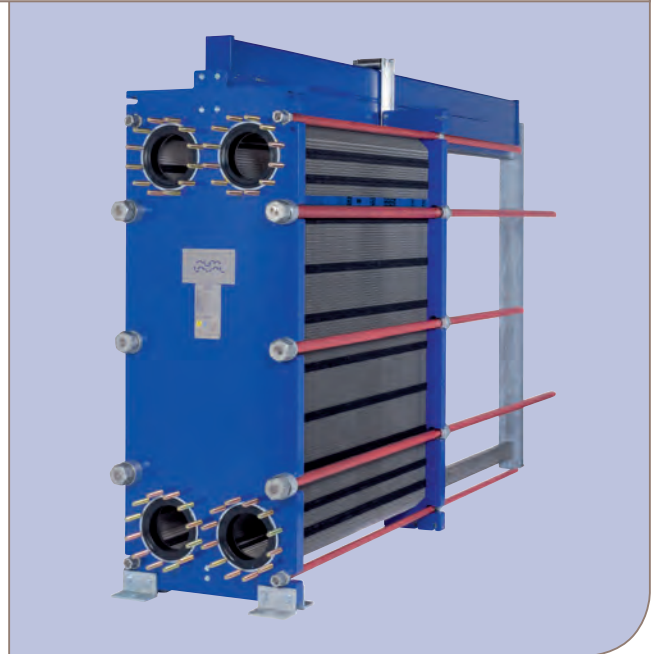

Flow principle of a plate heat exchanger

## STANDARD MATERIALS

### Frame plate

Mild steel, Epoxy painted

### Nozzles

Rubber lined

Carbon steel

Metal lined: Stainless steel, Titanium, Alloy C-276

### Plates

Stainless steel Alloy 304, Stainless steel Alloy 316, Alloy 254 SMO, Alloy C-276 or Titanium Other grades and material available on request.

### Gaskets

Nitrile, EPDM or Viton

Other grades and material available on request.

## TECHNICAL DATA

### Mechanical design pressure (g) / temperature

FM	pvcALS™	1.0 MPa / 180°C
FG	pvcALS™	1.6 MPa / 180°C
FG	PED	1.6 MPa / 180°C
FG	ASME	150 psig / 480°F
FD	ASME	300 psig / 480°F
FS	PED	3.0 MPa / 160°C
FS	ASME	400 psig / 480°F

## CONNECTIONS

Size: DN200 / NPS 8 / 200A

FM	pvcALS™	EN 1092-1 PN10, ASME B16.5 Class 150, JIS B2220 10K
FG	pvcALS™	EN 1092-1 PN16, , ASME B16.5 Class 150, JIS B2220 10K, JIS B2220 16K
FG	PED	EN 1092-1 PN10; EN 1092-1 PN16, EN 1092-1 PN25, ASME B16.5 Class 150
FG	ASME	ASME B16.5 Class 150
FD	ASME	ASME B16.5 Class 150, ASME B16.5 Class 300
FS	pvcALS™	EN 1092-1 PN25, EN 1092-1 PN40, ASME B16.5 Class 300
FS	PED	ASME B16.5 Class 400, JIS B2220 20K
FS	ASME	EN 1092-1 PN25, EN 1092-1 PN40, ASME B16.5 Class 300
FS	ASME	ASME B16.5 Class 400
FS	ASME	ASME B16.5 Class 300, ASME B16.5 Class 400

Standard EN 1092-1 corresponds to GOST 12815-80 and GB/T 9115.

### Maximum heat transfer surface

630 m<sup>2</sup> (7000 sq. ft)

## Dimensions

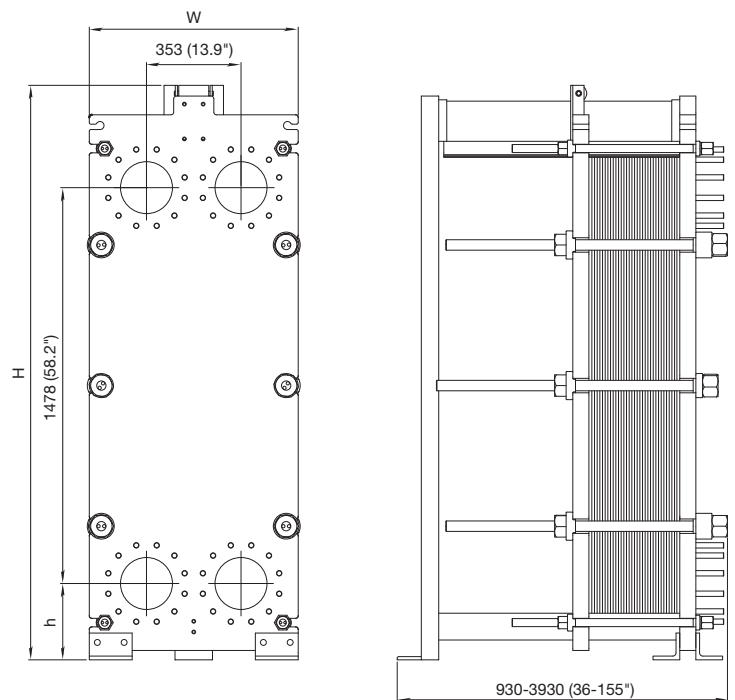

## Measurements mm (inch)

Type	H	W	h
T20-FM	2145 (84 1/2")	780 (30 11/16")	285 (11 7/32)
T20-FG	2145 (84 1/2")	780 (30 11/16")	285 (11 7/32)
T20-FS	2183 (84 1/2")	780 (30 11/16")	323 (12 11/16)

The number of tightening bolts may vary depending on pressure rating.

## Particulars required for quotation

- Flow rates or heat load
- Temperature program
- Physical properties of liquids in question (if not water)
- Desired working pressure
- Maximum permitted pressure drop
- Available steam pressure

### How to contact Alfa Laval

Up-to-date AlfaLaval contact details for all countries are always available on our website on [www.alfalaval.com](http://www.alfalaval.com)



# Alfa Laval MX25

## Gasketed plate-and-frame heat exchanger

### Applications

Plate heat exchanger for general heating and cooling duties.

### Standard design

The plate heat exchanger consists of a pack of corrugated metal plates with portholes for the passage of the two fluids between which heat transfer will take place.

The plate pack is assembled between a fix frame plate and a movable pressure plate and compressed by tightening bolts. The plates are fitted with a gasket, which seals the interplate channel and directs the fluids into alternate channels. The number of plates is determined by the flow rate, physical properties of the fluids, pressure drop and temperature program. The plate corrugations promote fluid turbulence and support the plates against differential pressure.

The plate and the pressure plate are suspended from an upper carrying bar and located by a lower guiding bar, both of which are fixed to a support column.

Connections are located in the frame plate or, if either or both fluids make more than a single pass within the unit, in the frame and pressure plates.

### Typical capacities

Liquid flow rate.

Up to 350 kg/s (5600 gpm), depending on media, permitted pressure drop and temperature program.

### Plate types

MX25B and MX25M plates

### Frame types

FMS, FGS, FG, FD and FS

### Working principle

Channels are formed between the plates and the corner ports are arranged so that the two media flow through alternate channels. The heat is transferred through the plate between the channels, and complete counter-current flow is created for highest possible efficiency. The corrugation of the plates provides the passage between the plates, supports each plate against the adjacent one and enhances the turbulence, resulting in efficient heat transfer.

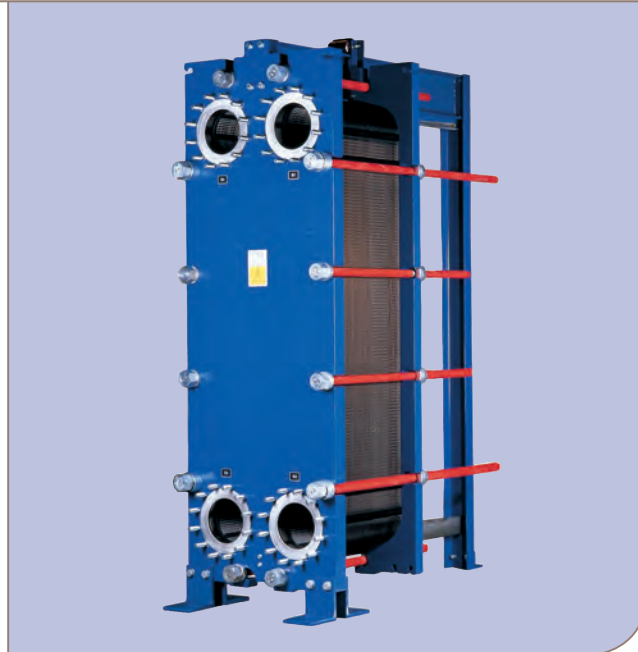

MX25-BFG

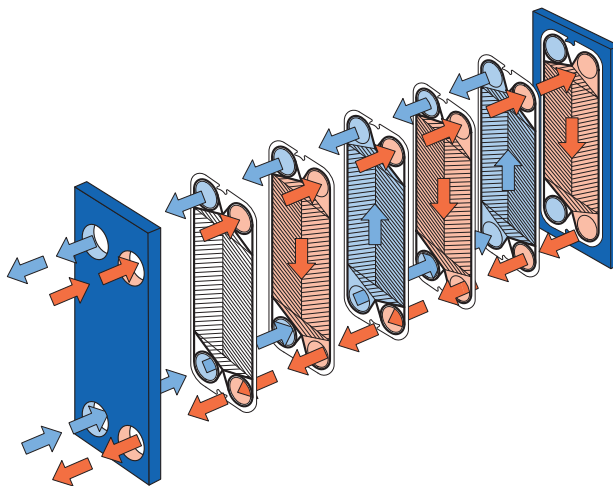

Flow principle of a plate heat exchanger



## STANDARD MATERIALS

### Frame plate

Mild steel, Epoxy painted

### Nozzles

Carbon steel

Metal lined: Stainless steel, Titanium, Alloy C276, Rubber lined: Nitrile, EPDM

### Plates

Stainless steel Alloy 316, Alloy C276, Alloy 254 SMO or Titanium Other grades and material available on request.

### Gaskets

Nitrile, EPDM or Viton

Other grades and material available on request.

## TECHNICAL DATA

### Pressure vessel codes PED, ASME, pvcALS™

#### Mechanical design pressure (g) / temperature

FMS PED, pvcALS™	1.0 MPa / 180°C
FGS PED, pvcALS™	1.6 MPa / 180°C
FGS ASME	150 psig / 350°F
FG PED, pvcALS™	1.6 MPa / 200°C
FG ASME	150 psig / 350°F
FD PED, pvcALS™	2.5 MPa / 210°C
FD ASME	300 psig / 350°F
FS ASME	400 psig / 350°F

### Connections

Size: DN200 / DN250 / NPS 8 / NPS 10 / 200A / 250A

FMS PED	EN 1092-1 PN10, ASME B16.5 Class 150
FMS pvcALS™	EN 1092-1 PN10, ASME B16.5 Class 150, JIS B2220 10K
FGS PED	EN 1092-1 PN16, ASME B16.5 Class 150
FGS pvcALS™	EN 1092-1 PN16, ASME B16.5 Class 150, JIS B2220 10K, JIS B2220 16K
FGS ASME	ASME B16.5 Class 150
FG PED	EN 1092-1 PN16, ASME B16.5 Class 150
FG pvcALS™	EN 1092-1 PN16, ASME B16.5 Class 150, JIS B2220 10K, JIS B2220 16K
FG ASME	ASME B16.5 Class 150
FD PED	EN 1092-1 PN25, ASME B16.5 Class 300
FD pvcALS™	EN 1092-1 PN25, ASME B16.5 Class 300, JIS B2220 20K
FD ASME	ASME B16.5 Class 300
FS ASME	ASME B16.5 Class 400

### Maximum heat transfer surface

940 m<sup>2</sup> (10000 sq. ft)

## Dimensions

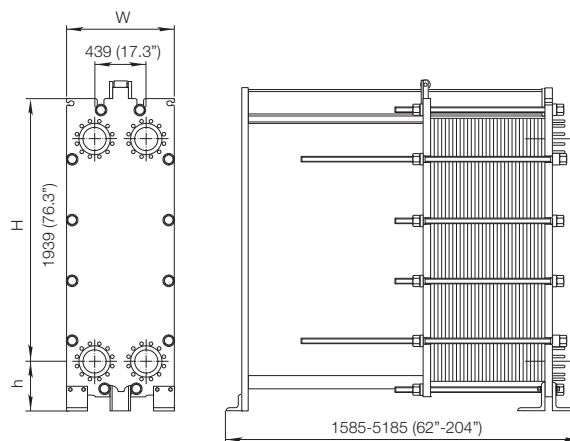

### Measurements mm (inch)

Type	H	W	h
MX25-FMS	2595 (102")	920 (36.2")	325 (12.8")
MX25-FGS	2595 (102")	920 (36.2")	325 (12.8")
MX25-FG	max 3103 (122.2")	920 (36.2")	435 (17.1")
MX25-FD	max 3103 (122.2")	940 (37")	435 (17.1")
MX25-FS	max 3103 (122.2")	940 (37")	435 (17.1")

The number of tightening bolts may vary depending on the pressure rating

### Particulars required for quotation

- Flow rates or heat load
- Temperature program
- Physical properties of liquids in question (if not water)
- Desired working pressure
- Maximum permitted pressure drop
- Available steam pressure

### How to contact Alfa Laval

Up-to-date AlfaLaval contact details for all countries are always available on our website on [www.alfalaval.com](http://www.alfalaval.com)



# Alfa Laval TS35

## Gasketed plate-and-frame heat exchanger

### Applications

General heating and cooling duties.

### Standard design

The plate heat exchanger consists of a pack of corrugated metal plates with port holes for the passage of the two fluids between which heat transfer will take place.

The plate pack is assembled between a fixed frame plate and a movable pressure plate and compressed by tightening bolts. The plates are fitted with gaskets, which seal the interplate channels and direct the fluid into alternate channels. The number of plates is determined by the flow rate, physical properties of the fluids, pressure drop and temperature program. The plate corrugations promote fluid turbulence and support the plates against differential pressure.

The frame plate and the pressure plate are suspended from an upper carrying bar and located by a lower guiding bar, both of which are fixed to a support column.

Connections are located in the frame plate or, if either or both fluids make more than a single pass within the unit, in the frame and pressure plate.

### Working principle

Channels are formed between the plates and the corner ports are arranged so that the two fluids flow through alternate channels. The heat is transferred through the plate between the channels, and complete counter-current flow is created for highest possible efficiency. The corrugation of the plates provides the passage between the plates, supports each plate against the adjacent one and enhances the turbulence, resulting in efficient heat transfer.

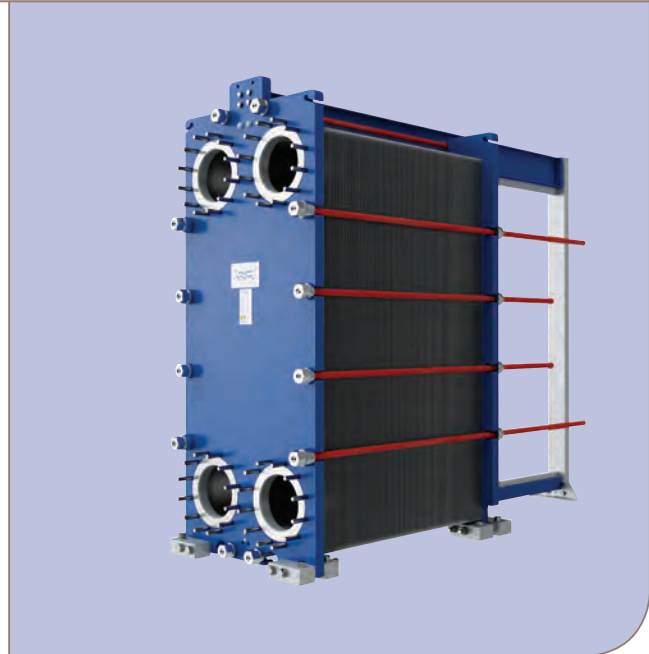

TS35

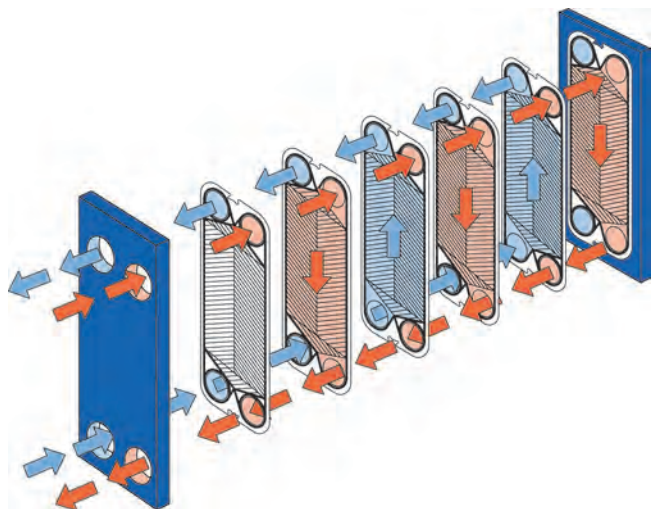

Flow principle of a plate heat exchanger

## STANDARD MATERIAL

### Frame/pressure plate

Mild steel, coated with water-based epoxy paint

Customized paint systems may be available on request.

### Nozzles/Connections

Carbon steel

Metal lined: Stainless steel Alloy 316, Titanium

Other materials may be available on request.

### Plates

Stainless steel Alloy 304, Alloy 316, Titanium

Other materials may be available on request.

### Gaskets

Nitrile, EPDM or Viton

Other grades and materials may be available on request.

## TECHNICAL DATA

### Design pressure (g)

FM	pvcALS™	1.034 MPa
FM	PED	1.034 MPa
FG	pvcALS™	1.6 MPa
FG	PED	1.6 MPa
FG	ASME	150 psig
FD	pvcALS™	2.5 MPa
FD	PED	2.5 MPa
FD	ASME	300 psig
FS	ASME	400 psig

Higher pressures may be available on request.

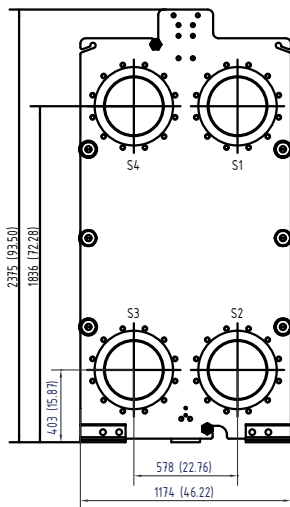

### Design temperature

Determined by gasket material.

### Plate types

TS35-P

### Connection size

DN350 / NPS 14 / 350A

DN300 / NPS 12 / 300A

### Connection standard

FM	pvcALS™	EN 1092-1 PN10, ASME B16.5 Class 150, JIS B2220 10K
FM	PED	EN 1092-1 PN10, ASME B16.5 Class 150
FG	pvcALS™	EN 1092-1 PN16, ASME B16.5 Class 150, JIS B2220 16K
FG	PED	EN 1092-1 PN16, ASME B16.5 Class 150
FG	ASME	ASME B16.5 Class 150
FD	pvcALS™	EN 1092-1 PN25, ASME B16.5 Class 300, JIS B2220 20K
FD	PED	EN 1092-1 PN25, ASME B16.5 Class 300
FD	ASME	ASME B16.5 Class 300
FS	ASME	ASME B16.5 Class 400

Standard EN 1092-1 corresponds to GOST 12815-80 and GB/T 9115.

Extended connections are available for ASME B16.5 Class 150, Class 300, Class 400 size NPS 14.

### Particulars required for quotation

- Flow rates or heat load
- Temperature program
- Physical properties of fluids in question
- Desired working pressure and temperature
- Allowable pressure drops

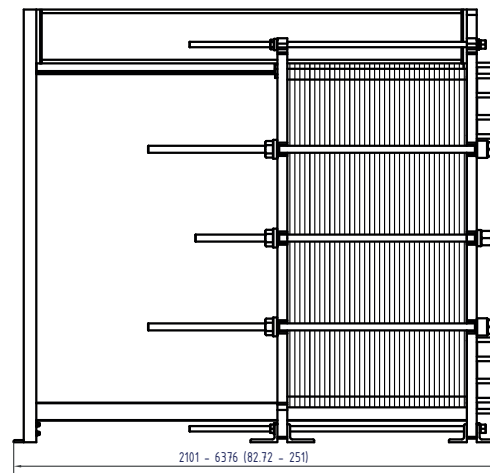

The number of tightening bolts may vary depending on pressure rating.

### How to contact Alfa Laval

Up-to-date AlfaLaval contact details for all countries are always available on our website on [www.alfalaval.com](http://www.alfalaval.com)



# Alfa Laval T35

## Gasketed plate-and-frame heat exchanger

### Applications

General heating and cooling duties.

### Standard design

The plate heat exchanger consists of a pack of corrugated metal plates with port holes for the passage of the two fluids between which heat transfer will take place.

The plate pack is assembled between a fixed frame plate and a movable pressure plate and compressed by tightening bolts. The plates are fitted with gaskets, which seal the interplate channels and direct the fluid into alternate channels. The number of plates is determined by the flow rate, physical properties of the fluids, pressure drop and temperature program. The plate corrugations promote fluid turbulence and support the plates against differential pressure.

The frame plate and the pressure plate are suspended from an upper carrying bar and located by a lower guiding bar, both of which are fixed to a support column.

Connections are located in the frame plate or, if either or both fluids make more than a single pass within the unit, in the frame and pressure plate.

### Working principle

Channels are formed between the plates and the corner ports are arranged so that the two fluids flow through alternate channels. The heat is transferred through the plate between the channels, and complete counter-current flow is created for highest possible efficiency. The corrugation of the plates provides the passage between the plates, supports each plate against the adjacent one and enhances the turbulence, resulting in efficient heat transfer.

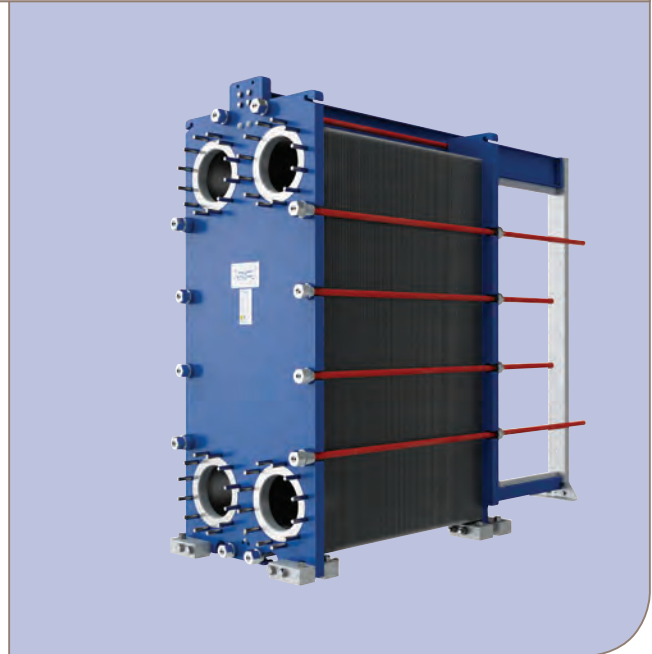

T35

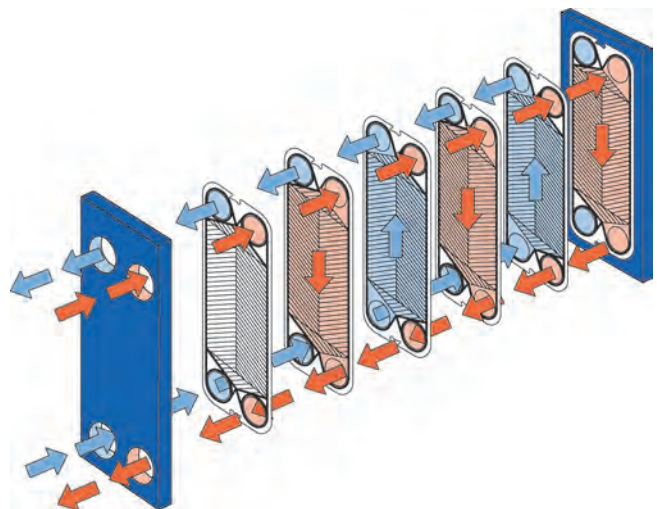

Flow principle of a plate heat exchanger



## STANDARD MATERIAL

### Frame/pressure plate

Mild steel, coated with water-based epoxy paint

Customized paint systems may be available on request.

### Nozzles/Connections

Carbon steel

Metal lined: Stainless steel Alloy 316, Titanium

Other materials may be available on request.

### Plates

Stainless steel Alloy 304, Alloy 316, Titanium

Other materials may be available on request.

### Gaskets

Nitrile, EPDM or Viton

Other grades and materials may be available on request.

## TECHNICAL DATA

### Design pressure (g)

FL	pvcALS™	0.6 MPa
FM	pvcALS™	1.034 MPa
FM	PED	1.034 MPa
FG	pvcALS™	1.6 MPa
FG	PED	1.6 MPa
FG	ASME	150 psig
FD	pvcALS™	2.5 MPa
FD	PED	2.5 MPa
FD	ASME	300 psig
FS	ASME	400 psig

Higher pressures may be available on request.

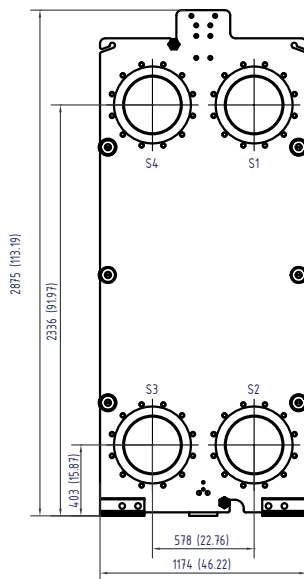

### Design temperature

Determined by gasket material.

### Plate types

T35-P

### Connection size

DN350 / NPS 14 / 350A

DN300 / NPS 12 / 300A

### Connection standard

FL	pvcALS™	EN 1092-1 PN10, ASME B16.5 Class 150, JIS B2220 10K
FM	pvcALS™	EN 1092-1 PN10, ASME B16.5 Class 150, JIS B2220 10K
FM	PED	EN 1092-1 PN10, ASME B16.5 Class 150
FG	pvcALS™	EN 1092-1 PN16, ASME B16.5 Class 150, JIS B2220 16K
FG	PED	EN 1092-1 PN16, ASME B16.5 Class 150
FG	ASME	ASME B16.5 Class 150
FD	pvcALS™	EN 1092-1 PN25, ASME B16.5 Class 300, JIS B2220 20K
FD	PED	EN 1092-1 PN25, ASME B16.5 Class 300
FD	ASME	ASME B16.5 Class 300
FS	ASME	ASME B16.5 Class 400

Standard EN 1092-1 corresponds to GOST 12815-80 and GB/T 9115.

Extended connections are available for ASME B16.5 Class 150, Class 300, Class 400 size NPS 14.

### Particulars required for quotation

- Flow rates or heat load
- Temperature program
- Physical properties of fluids in question
- Desired working pressure and temperature
- Allowable pressure drops

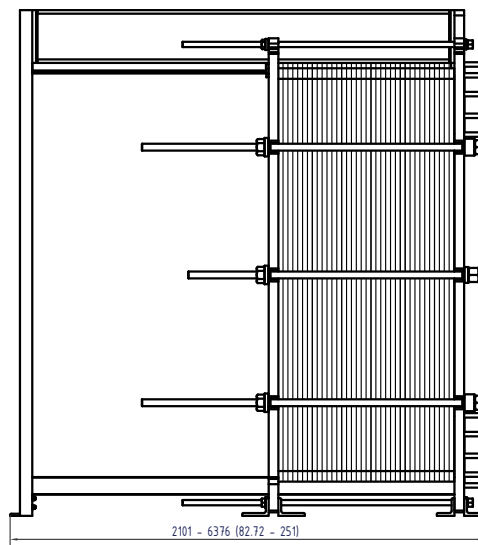

The number of tightening bolts may vary depending on pressure rating.

PCT00190EN 1505

Alfa Laval reserves the right to change specifications without prior notification.

### How to contact Alfa Laval

Up-to-date AlfaLaval contact details for all countries are always available on our website on [www.alfalaval.com](http://www.alfalaval.com)



# Alfa Laval TL35

## Gasketed plate-and-frame heat exchanger

### Applications

General heating and cooling duties.

### Standard design

The plate heat exchanger consists of a pack of corrugated metal plates with portholes for the passage of the two fluids between which heat transfer will take place.

The plate pack is assembled between a fix frame plate and a movable pressure plate and compressed by tightening bolts. The plates are fitted with a gasket, which seals the interplate channel and directs the fluids into alternate channels. The number of plates is determined by the flow rate, physical properties of the fluids, pressure drop and temperature program. The plate corrugations promote fluid turbulence and support the plates against differential pressure.

The frame plate is stationary, while the pressure plate is movable along the upper carrying bar, which also holds the plate pack. The pressure plate and the plate pack are located by the lower guiding bar. The carrying bar is supported by the frame at one end and a support column at the other which are bolted to the foundation.

Connections are located in the frame plate or, if either or both fluids make more than a single pass within the unit, in the frame and pressure plates.

### Typical capacities

#### Liquid flow rate

Up to 650 kg/s (10400 gpm), depending on media, permitted pressure drop and temperature program.

#### Plate types

TL35-B

#### Frame types

FM, FG, FD and FS

### Working principle

Channels are formed between the plates and the corner ports are arranged so that the two media flow through alternate channels. The heat is transferred through the plate between the channels, and complete counter-current flow is created for highest possible efficiency. The corrugation of the plates provides the passage between the plates, supports each plate against the adjacent one and enhances the turbulence, resulting in efficient heat transfer.

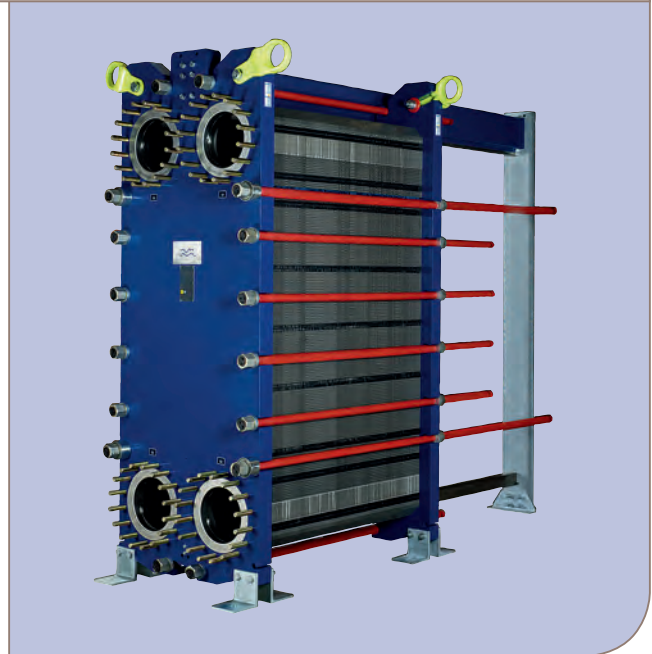

TL35-FD

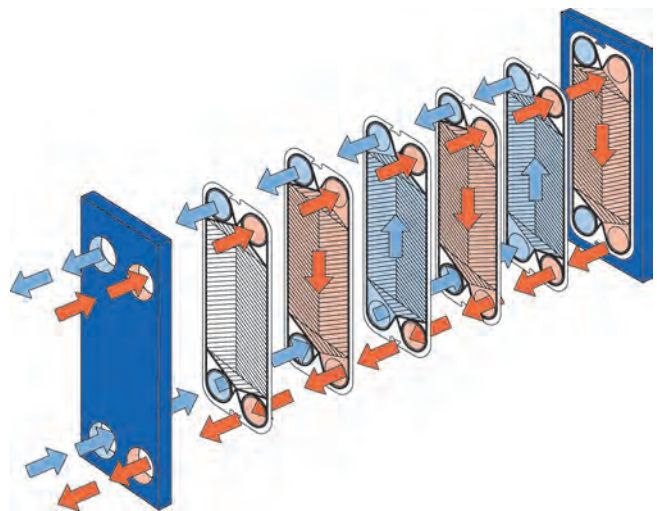

Flow principle of a plate heat exchanger

## STANDARD MATERIALS

### Frame plate

Mild steel, Epoxy painted

### Nozzles

Carbon steel

Metal lined: Stainless steel, Titanium, C276

### Plates

Stainless steel Alloy 316 / Alloy 304 / Alloy 254 / Alloy C276 / Titanium

Other grades and material available on request.

### Gaskets

Nitrile, EPDM or Viton

Other grades and material available on request.

## TECHNICAL DATA

### Pressure vessel codes, PED, ASME, pvcALS™

#### Mechanical design pressure (g) / temperature

FM	PED / pvcALS™	1.0 MPa / 180°C
FM	ASME	100 psig / 350°F
FG	PED / pvcALS™	1.6 MPa / 180°C
FG	ASME	150psig / 350°F
FD	PED	2.5 MPa / 180°C
FD	ALS	2.5 MPa / 160°C
FD	ASME	300 psig / 350°F
FS	PED	3.0 MPa / 180°C
FS	ASME	400 psig / 350°F

## Connections

Size: DN350 / NPS 14 / 350A  
DN300 / NPS 12 / 300A

FM	pvcALS™	EN 1092-1 PN10, ASME B16.5.Class 150, JIS B2220 10K
FM	PED	EN 1092-1 PN10, ASME B16.5.Class 150
FM	ASME	ASME B16.5.Class 150
FG	pvcALS™	EN 1092-1 PN16, ASME B16.5.Class 150, JIS B2220 16K
FG	PED	EN 1092-1 PN16, ASME B16.5.Class 150
FG	ASME	ASME B16.5.Class 150
FD	PED	EN 1092-1 PN25, ASME B16.5.Class 150, ASME B16.5.Class 300
FD	ALS	EN 1092-1 PN25, ASME B16.5.Class 150, ASME B16.5.Class 300 JIS B2220 20K
FD	ASME	ASME B16.5.Class 150, ASME B16.5.Class 300
FS	PED	EN 1092-1 PN25, EN 1092-1 PN40, ASME B16.5.Class 300 ASME B16.5.Class 400
FS	ASME	ASME B16.5.Class 300, ASME B16.5.Class 400

Standard EN 1092-1 corresponds to GOST 12815-80 and GB/T 9115.

## Dimensions

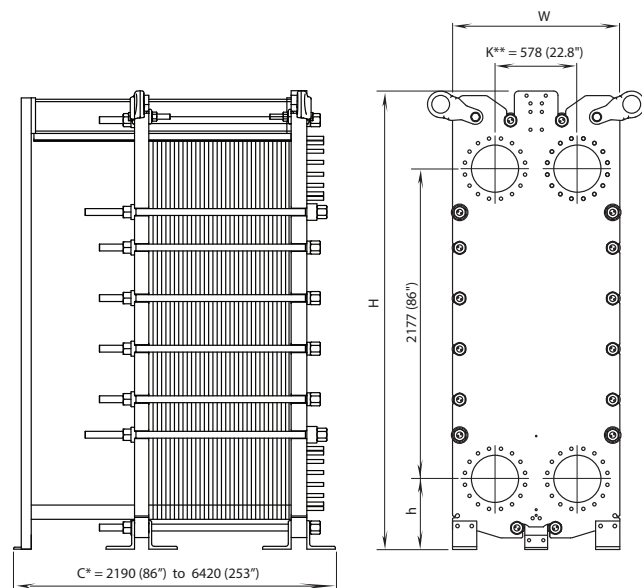

## Measurements mm (inch)

Type	H	W	h
TL35-FM	3210 (126.4")	1154 (45.4")	488 (19.2")
TL35-FG	3210 (126.4")	1154 (45.4")	488 (19.2")
TL35-FD	3218 (126.7")	1174 (46.2")	496 (19.5")
TL35-FS	3218 (126.7")	1174 (46.2")	496 (19.5")

The number of tightening bolts may vary depending on pressure rating.

C\* = Larger design available on request.

K\*\* = 578 mm (22.8 inches) except following cases

584 (23.0") FS PED	Size 350 DN PN40
589 (23.2") FD PED/pvcALS™ ASME	Size 14" ASME Cl.300
589 (23.2") FS PED/ASME	Size 14" ASME Cl 300 or 400

## Particulars required for quotation

- Flow rates or heat load
- Temperature program
- Physical properties of liquids in question (if not water)
- Desired working pressure
- Maximum permitted pressure drop
- Available steam pressure

PCT00061EN 1411

Alfa Laval reserves the right to change specifications without prior notification.

## How to contact Alfa Laval

Up-to-date AlfaLaval contact details for all countries are always available on our website on [www.alfalaval.com](http://www.alfalaval.com)



# Alfa Laval T45

## Gasketed plate-and-frame heat exchanger

### Applications

General heating and cooling duties.

### Standard design

The plate heat exchanger consists of a pack of corrugated metal plates with port holes for the passage of the two fluids between which heat transfer will take place.

The plate pack is assembled between a fixed frame plate and a movable pressure plate and compressed by tightening bolts. The plates are fitted with gaskets, which seal the interplate channels and direct the fluid into alternate channels. The number of plates is determined by the flow rate, physical properties of the fluids, pressure drop and temperature program. The plate corrugations promote fluid turbulence and support the plates against differential pressure.

The frame plate and the pressure plate are suspended from an upper carrying bar and located by a lower guiding bar, both of which are fixed to a support column.

Connections are located in the frame plate or, if either or both fluids make more than a single pass within the unit, in the frame and pressure plate.

### Working principle

Channels are formed between the plates and the corner ports are arranged so that the two fluids flow through alternate channels. The heat is transferred through the plate between the channels, and complete counter-current flow is created for highest possible efficiency. The corrugation of the plates provides the passage between the plates, supports each plate against the adjacent one and enhances the turbulence, resulting in efficient heat transfer.

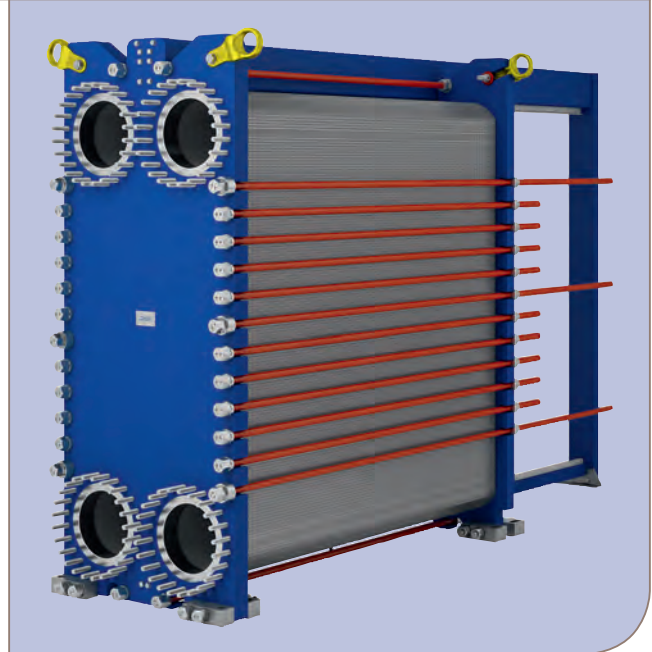

T45-M

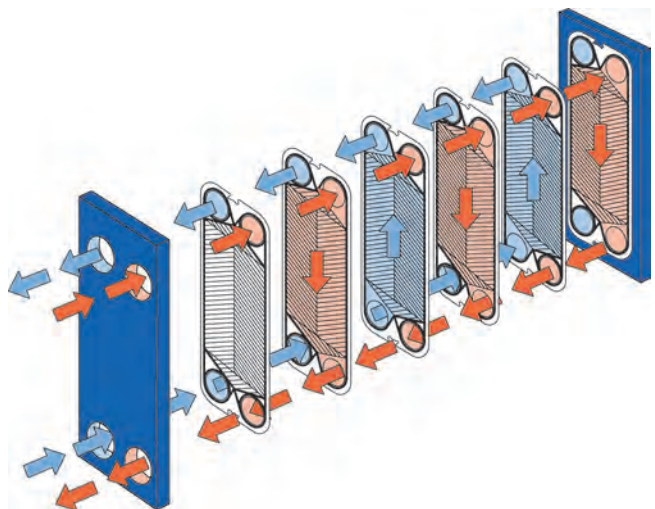

Flow principle of a plate heat exchanger



## STANDARD MATERIAL

### Frame/pressure plate

Mild steel, coated with water-based epoxy paint

### Nozzles/Connections

Carbon steel

Metal lined: Stainless steel Alloy 316, Alloy 254, Titanium

### Plates

Stainless steel Alloy 316, Alloy 254, Titanium

Other materials may be available on request.

### Gaskets

Nitrile, EPDM or Viton

Other materials may be available on request.

## TECHNICAL DATA

### Design pressure (g)

FM	pvcALS™	1.0 MPa
FG	PED	1.6 MPa
FG	pvcALS™	1.6 MPa
FG	ASME	150 psig
FD	ASME	250 psig

Higher pressures may be available on request.

### Design temperature

Determined by gasket material.

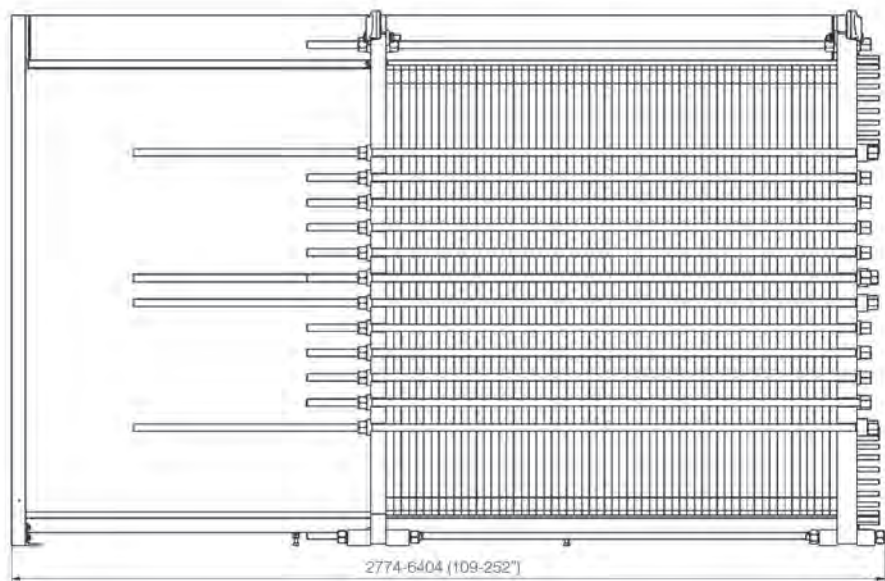
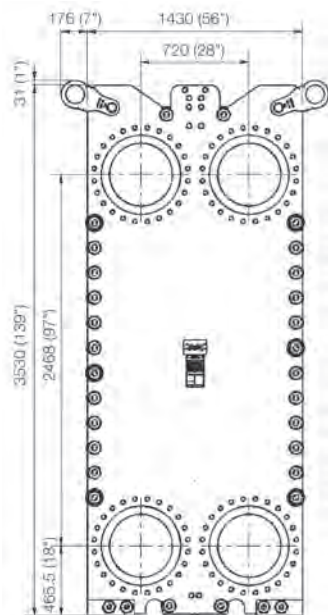

The number of tightening bolts may vary depending on pressure rating.

### Maximum liquid flow rate

Up to 1000 kg/s (16000 gpm)

### Maximum standard heat transfer surface

2360 m<sup>2</sup> (25400 sq. ft)

Larger non-standard design available on request.

### Plate types

T45-M

### Connection size

DN450 / NPS 18 / 450A

### Connections

FM	pvcALS™	EN 1092-1 PN10, ASME B16.5 Class 150, JIS B2220 10K
FG	PED	EN 1092-1 PN16, ASME B16.5 Class 150
FG	pvcALS™	EN 1092-1 PN16, ASME B16.5 Class 150, JIS B2220 16K
FG	ASME	ASME B16.5 Class 150
FD	ASME	ASME B16.5 Class 300

Standard EN 1092-1 corresponds to GOST 12815-80 and GB/T 9115.

### Particulars required for quotation

- Flow rates or heat load
- Temperature program
- Physical properties of fluids in question
- Desired working pressure and temperature
- Allowable pressure drops

### How to contact Alfa Laval

Up-to-date AlfaLaval contact details for all countries are always available on our website on [www.alfalaval.com](http://www.alfalaval.com)



# Alfa Laval TS50

## Gasketed plate-and-frame heat exchanger

### Applications

General heating and cooling duties

### Standard design

The plate heat exchanger consists of a pack of corrugated metal plates with portholes for the passage of the two fluids between which heat transfer will take place.

The plate pack is assembled between a fix frame plate and a movable pressure plate and compressed by tightening bolts. The plates are fitted with a gasket, which seals the interplate channel and directs the fluids into alternate channels. The number of plates is determined by the flow rate, physical properties of the fluids, pressure drop and temperature program. The plate corrugations promote fluid turbulence and support the plates against differential pressure.

The frame plate and the pressure plate are suspended from an upper carrying bar and located by a lower guiding bar, both of which are fixed to a support column.

Connections are located in the frame plate or, if either or both fluids make more than a single pass within the unit, in the frame and pressure plates.

### Typical capacities

#### Liquid flow rate

Up to 1300kg/s (20800 gpm), depending on media, permitted pressure drop and temperature program.

#### Plate types

TS50-M

#### Frame types

FM, FG and FD

### Working principle

Channels are formed between the plates and the corner ports are arranged so that the two media flow through alternate channels. The heat is transferred through the plate between the channels, and complete counter-current flow is created for highest possible efficiency. The corrugation of the plates provides the passage between the plates, supports each plate against the adjacent one and enhances the turbulence, resulting in efficient heat transfer.

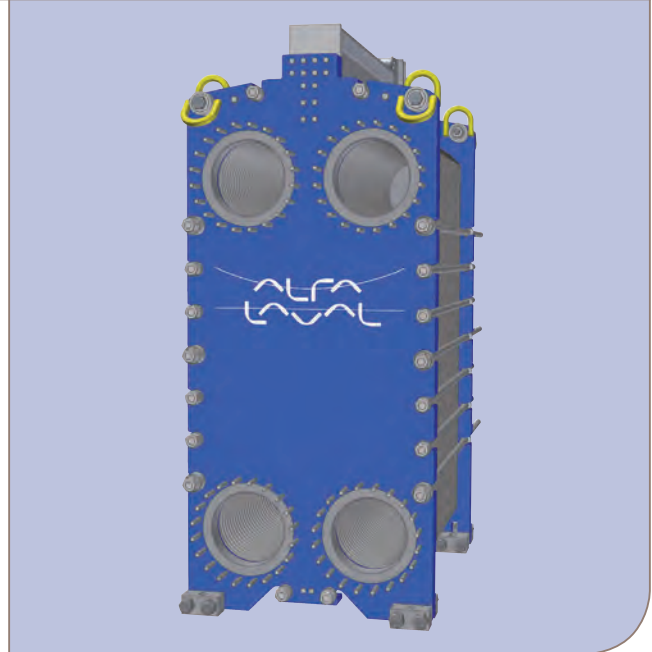

TS50-M

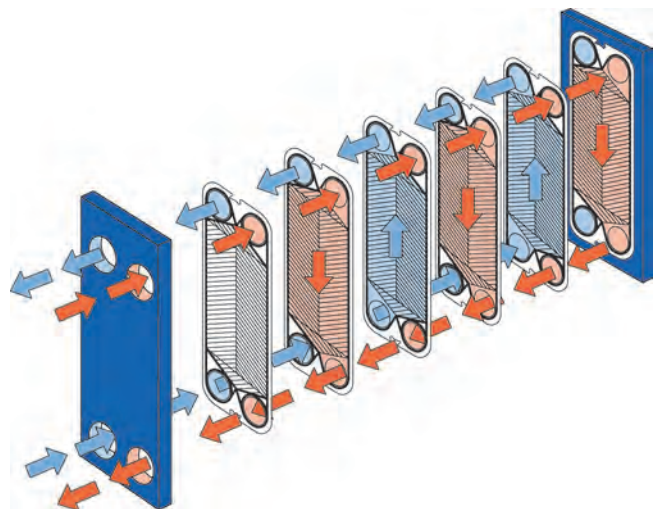

Flow principle of a plate heat exchanger

## STANDARD MATERIALS

### Frame plate

Mild steel, Epoxy painted

### Nozzles

Carbon steel

Metal lined: Stainless steel, Titanium

### Plates

Stainless steel Alloy 316 or Titanium.

### Gaskets

Nitrile or EPDM

## TECHNICAL DATA

### Mechanical design pressure (g) / temperature

FM	pvcALST™	1.0 MPa / 150°C
FG	PED	1.6 MPa / 180°C
FG	ASME	150 psig / 350°F
FD	PED	2.5 MPa / 180°C
FD	ASME	300 psig / 350°F

## CONNECTIONS

Size: DN500 / NPS 20

FM	pvcALST™	EN1092-1 PN10 ASME B16.5 Class 150
FG	PED	EN1092-1 PN10, EN1092-1 PN16 ASME B16.5 Class 150
FG	ASME	ASME B16.5 Class 150
FD	PED	EN1092-1 PN25 ASME B16.5 Class 300
FD	ASME	ASME B16.5 Class 150, ASME Cl. 300

Standard EN 1092-1 corresponds to GOST 12815-80 and GB/T 9115.

### Maximum heat transfer surface

2100 m<sup>2</sup> (22700 sq. ft)

## Dimensions

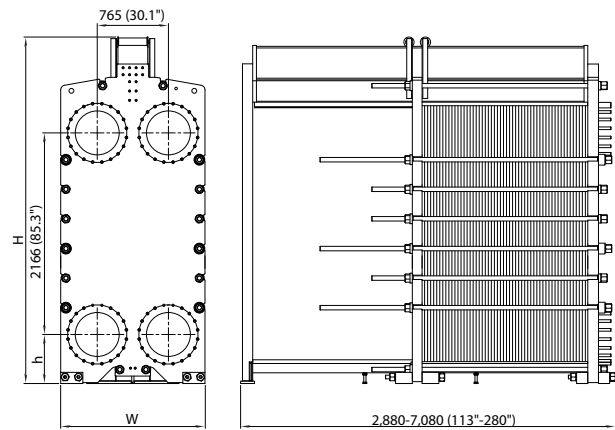

### Measurements mm (inch)

Type	H	W	h
TS50-MFM	3433(135 4/25")	1550 (61")	467(18 3/8")
TS50-MFG	3723(146 9/16")	1550 (61")	467(18 3/8")
TS50-MFD	3723(146 9/16")	1550 (61")	467(18 3/8")

The number of tightening bolts may vary depending on pressure rating.

### Particulars required for quotation

- Flow rates or heat load
- Temperature program
- Physical properties of liquids in question
- Desired working pressure
- Maximum permitted pressure drop
- Available steam pressure

### How to contact Alfa Laval

Up-to-date AlfaLaval contact details for all countries are always available on our website on [www.alfalaval.com](http://www.alfalaval.com)



# Alfa Laval T50

## Gasketed plate-and-frame heat exchanger

### Applications

General heating and cooling duties

### Standard design

The plate heat exchanger consists of a pack of corrugated metal plates with portholes for the passage of the two fluids between which heat transfer will take place.

The plate pack is assembled between a fix frame plate and a movable pressure plate and compressed by tightening bolts. The plates are fitted with a gasket, which seals the interplate channel and directs the fluids into alternate channels. The number of plates is determined by the flow rate, physical properties of the fluids, pressure drop and temperature program. The plate corrugations promote fluid turbulence and support the plates against differential pressure.

The frame plate and the pressure plate are suspended from an upper carrying bar and located by a lower guiding bar, both of which are fixed to a support column.

Connections are located in the frame plate or, if either or both fluids make more than a single pass within the unit, in the frame and pressure plates.

### Typical capacities

#### Liquid flow rate

Up to 975 kg/s (15500 gpm), depending on media, permitted pressure drop and temperature program.

### Plate types

T50-M

### Frame types

FM, FG and FD

### Working principle

Channels are formed between the plates and the corner ports are arranged so that the two media flow through alternate channels. The heat is transferred through the plate between the channels, and complete counter-current flow is created for highest possible efficiency. The corrugation of the plates provides the passage between the plates, supports each plate against the adjacent one and enhances the turbulence, resulting in efficient heat transfer.

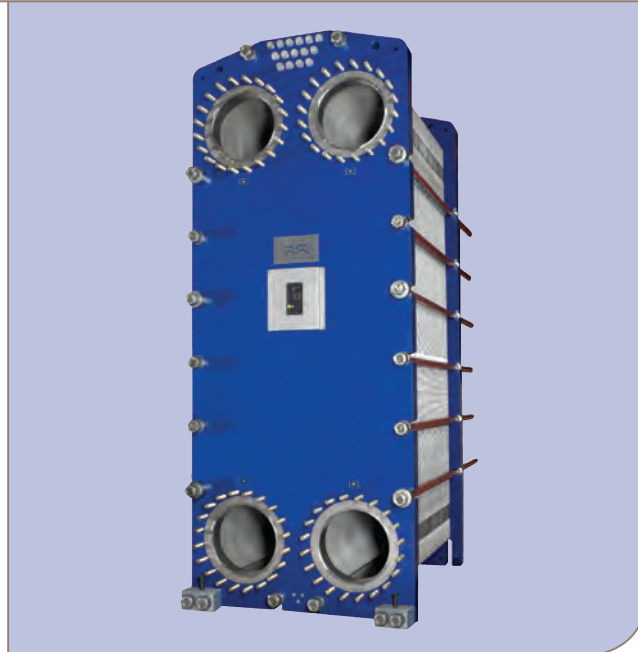

T50-M

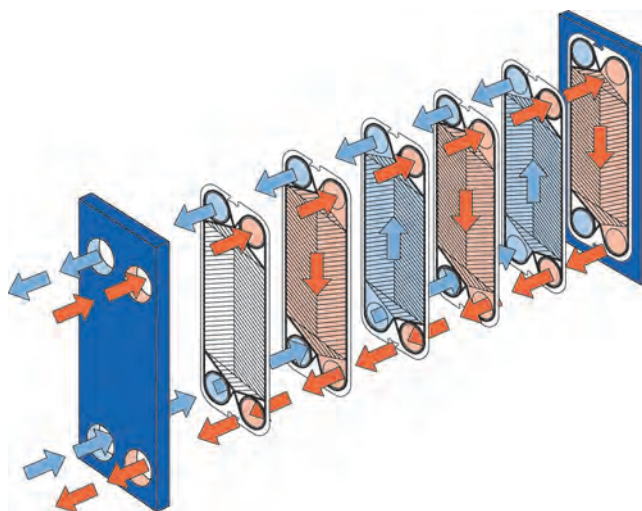

Flow principle of a plate heat exchanger



## STANDARD MATERIALS

### Frame plate

Mild steel, Epoxy painted

### Nozzles

Carbon steel

Metal lined: Stainless steel, Titanium

### Plates

Stainless steel Alloy 316, Alloy 254 or Titanium.

### Gaskets

Nitrile or EPDM

## TECHNICAL DATA

### Mechanical design pressure (g) / temperature

FM	pvcALSTM	1.0 MPa / 150°C
FG	PED	1.6 MPa / 180°C
FG	ASME	150 psig / 350°F
FD	PED	2.5 MPa / 180°C
FD	ASME	300 psig / 350°F

## CONNECTION STANDARD

Size: DN500 / NPS 20

FM	pvcALSTM	EN 1092-1 PN10 ASME B16.5 Class. 150
FG	PED	EN 1092-1 PN10, EN 1092-1 PN16 ASME B16.5 Class 150
FG	ASME	ASME B16.5 Class 150
FD	PED	EN 1092-1 PN25 ASME B16.5 Class 300
FD	ASME	ASME B16.5 Class 150, ASME B16.5 Class 300

Standard EN 1092-1 corresponds to GOST 12815-80 and GB/T 9115.

### Maximum heat transfer surface

2880 m<sup>2</sup> (31018 sq. ft)

## Dimensions

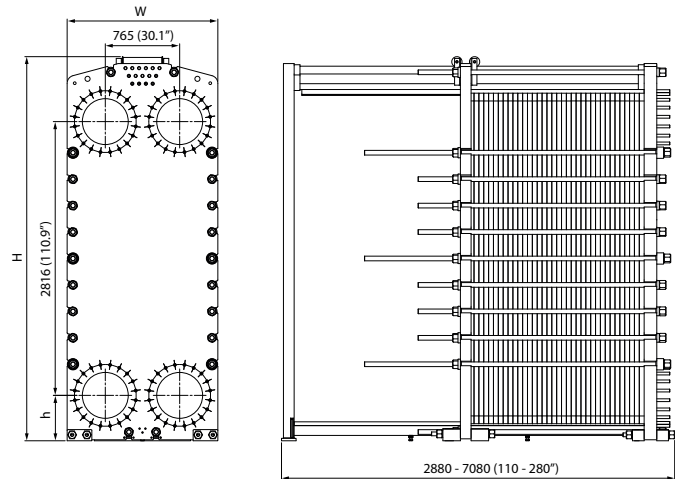

## Measurements mm (inch)

Type	H	W	h
T50-MFM	4095(161 <sup>7</sup> / <sub>8</sub> "	1550 (61")	467(18 <sup>3</sup> / <sub>8</sub> "
T50-MFG	3951(155 <sup>9</sup> / <sub>16</sub> "	1550 (61")	467(18 <sup>3</sup> / <sub>8</sub> "
T50-MFD	3951(155 <sup>9</sup> / <sub>16</sub> "	1550 (61")	467(18 <sup>3</sup> / <sub>8</sub> "

The number of tightening bolts may vary depending on pressure rating.

## Particulars required for quotation

- Flow rates or heat load
- Temperature program
- Physical properties of liquids in question
- Desired working pressure
- Maximum permitted pressure drop
- Available steam pressure

### How to contact Alfa Laval

Up-to-date AlfaLaval contact details for all countries are always available on our website on [www.alfalaval.com](http://www.alfalaval.com)



# Alfa Laval AQ1A

## AlfaQ™ AHRI-certified plate heat exchanger

### Applications

General heating and cooling duties.

### Standard design

The plate heat exchanger consists of a pack of corrugated metal plates with portholes for the passage of the two fluids between which heat transfer will take place.

The plate pack is assembled between a fix frame plate and a movable pressure plate and compressed by tightening bolts. The plates are fitted with a gasket which seals the interplate channel and directs the fluids into alternate channels. The number of plates is determined by the flow rate, physical properties of the fluids, pressure drop and temperature program. The plate corrugations promote fluid turbulence and support the plates against differential pressure.

The plate and the pressure plate are suspended from an upper carrying bar and located by a lower guiding bar.

Connections are located in the frame plate or, if either or both fluids make more than a single pass within the unit, in the frame and pressure plates.

### Typical capacities

#### Liquid flow rate

Up to 2 kg/s (30 gpm), depending on media, permitted pressure drop and temperature program.

#### Plate types

AQ1A-B plates

#### Frame types

FG

### Working principle

Channels are formed between the plates and the corner ports are arranged so that the two media flow through alternate channels. The heat is transferred through the plate between the channels, and complete counter-current flow is created for highest possible efficiency. The corrugation of the plates provides the passage between the plates, supports each plate against the adjacent one and enhances the turbulence, resulting in efficient heat transfer.

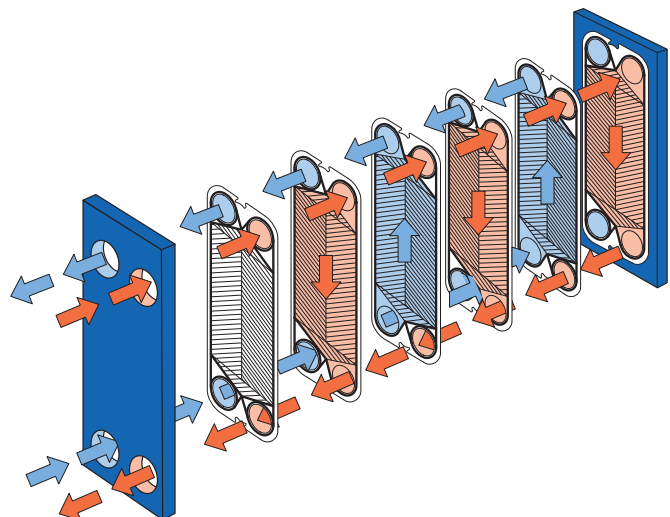

Flow principle of a plate heat exchanger

## STANDARD MATERIALS

### Frame plate

Mild steel, Epoxy painted

### Nozzles

Pipe: Stainless steel, Titanium

### Plates

Stainless steel Alloy 316, Titanium

### Gaskets

Nitrile, EPDM

## TECHNICAL DATA

Pressure vessel code pvcALS™

Mechanical design pressure (g) / temperature  
FG 1.6 MPa / 180°C

### Maximum heat transfer surface

1.0 m<sup>2</sup> (10.76 sq. ft)

### Connections

Straight pipe thread ISO-R 3/4"

### Particulars required for quotation

- Flow rates or heat load
- Temperature program
- Physical properties of liquids in question (if not water)
- Desired working pressure
- Maximum permitted pressure drop

## Dimensions mm (inch)

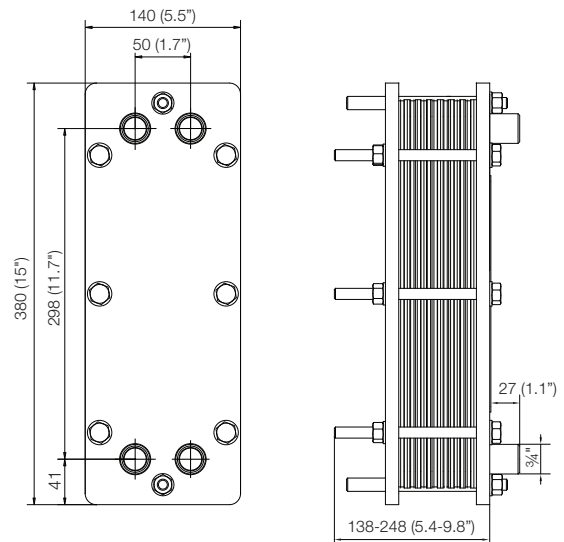

The thermal performance is third party certified through the AHRI Liquid to Liquid Heat Exchangers certification program



### How to contact Alfa Laval

Up-to-date AlfaLaval contact details for all countries are always available on our website on [www.alfalaval.com](http://www.alfalaval.com)



# Alfa Laval AQ1

## AlfaQ™ AHRI-certified plate heat exchanger

### Applications

General heating and cooling duties. Heating by means of steam.

### Standard design

The plate heat exchanger consists of a pack of corrugated metal plates with portholes for the passage of the two fluids between which heat transfer will take place.

The plate pack is assembled between a fix frame plate and a movable pressure plate and compressed by tightening bolts. The plates are fitted with a gasket which seals the interplate channel and directs the fluids into alternate channels. The number of plates is determined by the flow rate, physical properties of the fluids, pressure drop and temperature program. The plate corrugations promote fluid turbulence and support the plates against differential pressure.

The plate and the pressure plate are suspended from an upper carrying bar and located by a lower guiding bar.

Connections are located in the frame plate or, if either or both fluids make more than a single pass within the unit, in the frame and pressure plates.

### Typical capacities

#### Liquid flow rate

Up to 4 kg/s (60 gpm), depending on media, permitted pressure drop and temperature program.

#### Plate types

AQ1, AQ1D - double wall plates

#### Frame types

FG

#### Water heating by steam

50 to 250 kw

### Working principle

Channels are formed between the plates and the corner ports are arranged so that the two media flow through alternate channels. The heat is transferred through the plate between the channels, and complete counter-current flow is created for highest possible efficiency. The corrugation of the plates provides the passage between the plates, supports each plate against the adjacent one and enhances the turbulence, resulting in efficient heat transfer.

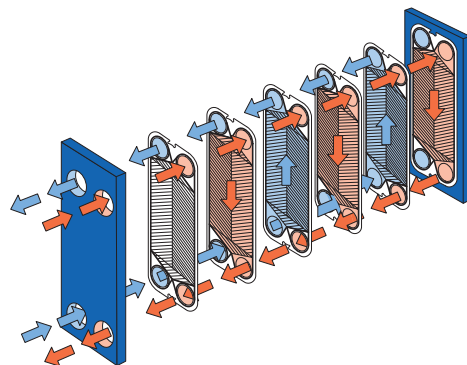
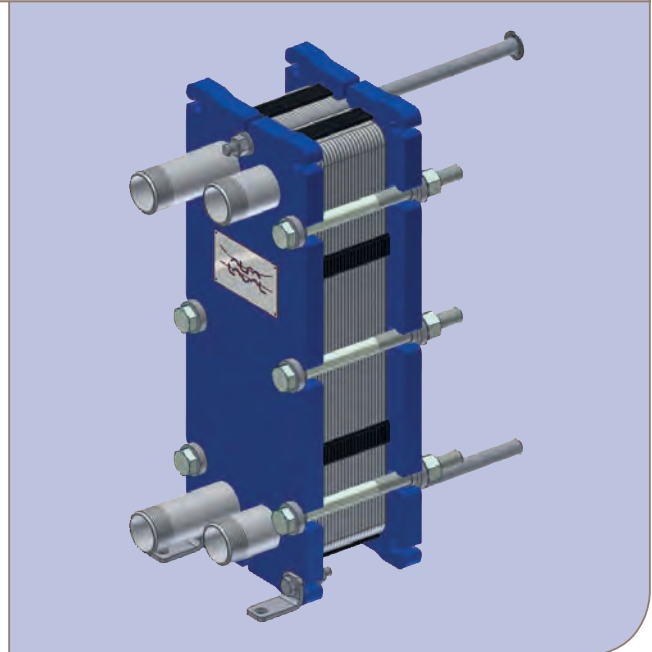

Flow principle of a plate heat exchanger



## STANDARD MATERIALS

### Frame plate

Mild steel, Epoxy painted

### Nozzles

Carbon steel

Pipe: Stainless steel, Titanium

### Plates

Stainless steel Alloy 316, Titanium

### Gaskets (Clip-on)

Nitrile, EPDM, Viton®

Other grades and material available on request.

## TECHNICAL DATA

### Pressure vessel codes PED, ASME, pvcALS™

#### Mechanical design pressure (g) / temperature

FG PED, pvcALS™ 1.6 MPa / 180°C

FG ASME 150 psig / 350°F

### Maximum heat transfer surface

3.9 m<sup>2</sup> (40 sq. ft)

### Connections

FG	PED	Size 1¼"	Pipe, thread ISO-R 1¼"
FG	pvcALS™	Size 1¼"	Pipe, thread ISO-R 1¼"
FG	pvcALS™	Size 1¼"	Internal thread ISO-G 1¼", carbon steel
FG	ASME	Size 1¼"	Pipe, thread NPT 1¼"

### Particulars required for quotation

- Flow rates or heat load
- Temperature program
- Physical properties of liquids in question (if not water)
- Desired working pressure
- Maximum permitted pressure drop
- Available steam pressure

## Dimensions

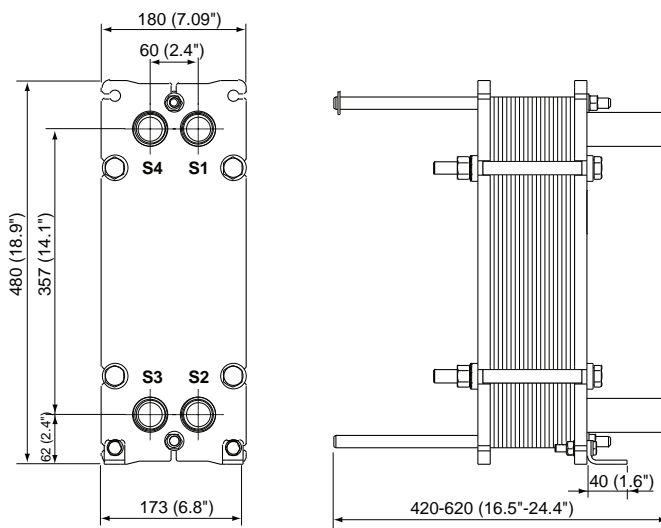

## Measurements mm (inch)

The number of bolts may vary depending on pressure rating.

The thermal performance is third party certified through the AHRI Liquid to Liquid Heat Exchangers certification program



### How to contact Alfa Laval

Up-to-date AlfaLaval contact details for all countries are always available on our website on [www.alfalaval.com](http://www.alfalaval.com)



# Alfa Laval AQ1L

## AlfaQ™ AHRI-certified plate heat exchanger

### Applications

General heating and cooling duties.

### Standard design

The plate heat exchanger consists of a pack of corrugated metal plates with portholes for the passage of the two fluids between which heat transfer will take place.

The plate pack is assembled between a fix frame plate and a movable pressure plate and compressed by tightening bolts. The plates are fitted with a gasket which seals the interplate channel and directs the fluids into alternate channels. The number of plates is determined by the flow rate, physical properties of the fluids, pressure drop and temperature program. The plate corrugations promote fluid turbulence and support the plates against differential pressure.

The plate and the pressure plate are suspended from an upper carrying bar and located by a lower guiding bar.

Connections are located in the frame plate or, if either or both fluids make more than a single pass within the unit, in the frame and pressure plates.

### Typical capacities

#### Liquid flow rate

Up to 5 kg/s (80 gpm), depending on media, permitted pressure drop and temperature program.

#### Plate types

AQ1L, AQ1LP, AQ1LD - double wall plates

#### Frame types

FG

### Working principle

Channels are formed between the plates and the corner ports are arranged so that the two media flow through alternate channels. The heat is transferred through the plate between the channels, and complete counter-current flow is created for highest possible efficiency. The corrugation of the plates provides the passage between the plates, supports each plate against the adjacent one and enhances the turbulence, resulting in efficient heat transfer.

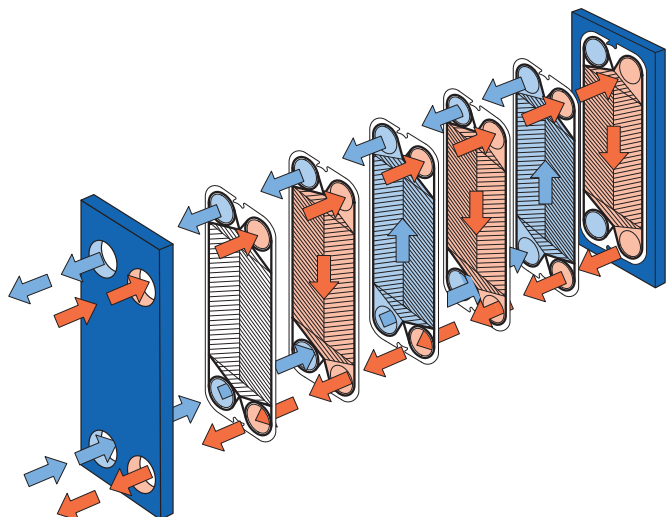

Flow principle of a plate heat exchanger

## STANDARD MATERIALS

### Frame plate

Mild steel, Epoxy painted

### Nozzles

Carbon steel

Pipe: Stainless steel, Titanium

### Plates

Stainless steel: Alloy 316 / Alloy 304, Titanium, Alloy 254 SMO.

### Gaskets

Nitrile, EPDM, Viton®

Other grades and material available on request.

## TECHNICAL DATA

Pressure vessel codes PED, ASME, pvcALS™

Mechanical design pressure (g) / temperature

FG pvcALS™ 1.6 MPa / 180°C

FG PED 1.6 MPa / 180°C

FG ASME 150 psig / 356°F

### Maximum heat transfer surface

10.9 m<sup>2</sup> (117.3 sq.ft)

### Connections

FG PED Size 1¼" Pipe, thread ISO-R 1¼"

FG pvcALS™ Size 1¼" Pipe, thread ISO-R 1¼" and NPT 1¼"

FG pvcALS™ Size 1¼" Internal thread ISO-G 1¼", carbon steel

FG ASME Size 1¼" Pipe, thread NPT 1¼"

## Dimensions

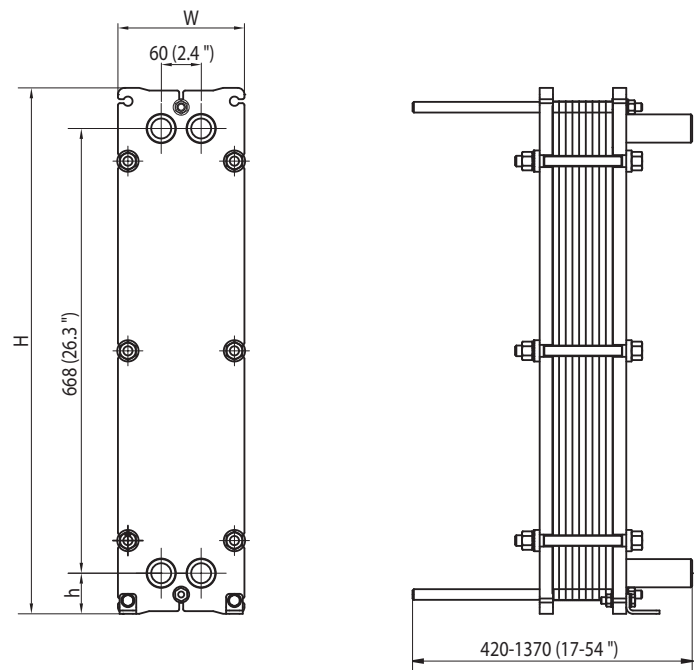

## Measurements mm (inch)

Type	H	W	h
AQ1L-FG	790 (31.1")	190 (7.5")	61 (2.4")

## Particulars required for quotation

- Flow rates or heat load
- Temperature program
- Physical properties of liquids in question (if not water)
- Desired working pressure
- Maximum permitted pressure drop

The thermal performance is third party certified through the AHRI Liquid to Liquid Heat Exchangers certification program



### How to contact Alfa Laval

Up-to-date AlfaLaval contact details for all countries are always available on our website on [www.alfalaval.com](http://www.alfalaval.com)



# Alfa Laval AQ2A

## AlfaQ™ AHRI-certified plate heat exchanger

### Applications

General heating and cooling duties.

### Standard design

The plate heat exchanger consists of a pack of corrugated metal plates with portholes for the passage of the two fluids between which heat transfer will take place.

The plate pack is assembled between a fix frame plate and a movable pressure plate and compressed by tightening bolts. The plates are fitted with a gasket which seals the interplate channel and directs the fluids into alternate channels. The number of plates is determined by the flow rate, physical properties of the fluids, pressure drop and temperature program. The plate corrugations promote fluid turbulence and support the plates against differential pressure.

The plate and the pressure plate are suspended from an upper carrying bar and located by a lower guiding bar.

Connections are located in the frame plate or, if either or both fluids make more than a single pass within the unit, in the frame and pressure plates.

### Typical capacities

#### Liquid flow rate

Up to 14 kg/s (222 gpm), depending on media, permitted pressure drop and temperature program.

#### Plate types

AQ2A-B, AQ2A-M plates

#### Frame types

FG

### Working principle

Channels are formed between the plates and the corner ports are arranged so that the two media flow through alternate channels. The heat is transferred through the plate between the channels, and complete counter-current flow is created for highest possible efficiency. The corrugation of the plates provides the passage between the plates, supports each plate against the adjacent one and enhances the turbulence, resulting in efficient heat transfer.

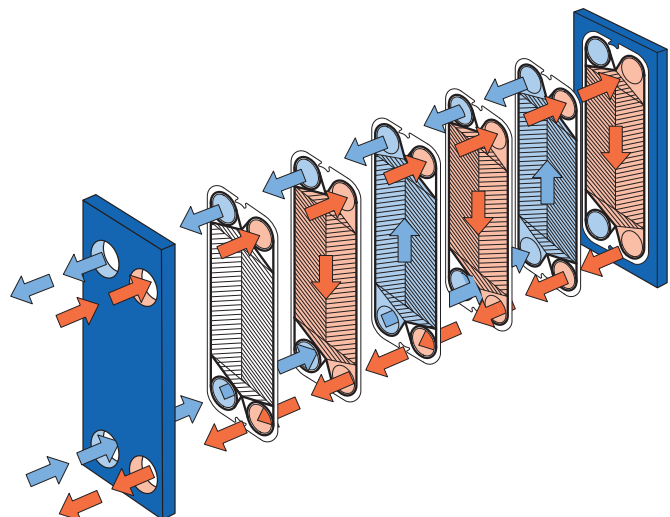

Flow principle of a plate heat exchanger



## STANDARD MATERIALS

### Frame plate

Mild steel, Epoxy painted

### Nozzles

Carbon steel

Pipe: Stainless steel, titanium

### Plates

Stainless steel Alloy 316 / Alloy 304

Titanium

### Gaskets

Nitrile, EPDM

## TECHNICAL DATA

Pressure vessel codes PED, ASME, pvcALS™

Mechanical design pressure (g) / temperature

FG	pvcALS™	1.6 MPa / 180°C
FG	PED	1.6 MPa / 160°C
FG	ASME	150 psig / 356°F

### Maximum heat transfer surface

AQ2A-B	7.1 m <sup>2</sup> (76.4 sq.ft)
AQ2A-M	4.4 m <sup>2</sup> (47.4 sq.ft)

### Connections

Straight threaded	Size 50 mm ISO G2"
Tapered threaded	Size 50 mm ISO R2", NPT2"
Threaded inlet port	Size 50 mm ISO-G2"

## Dimensions

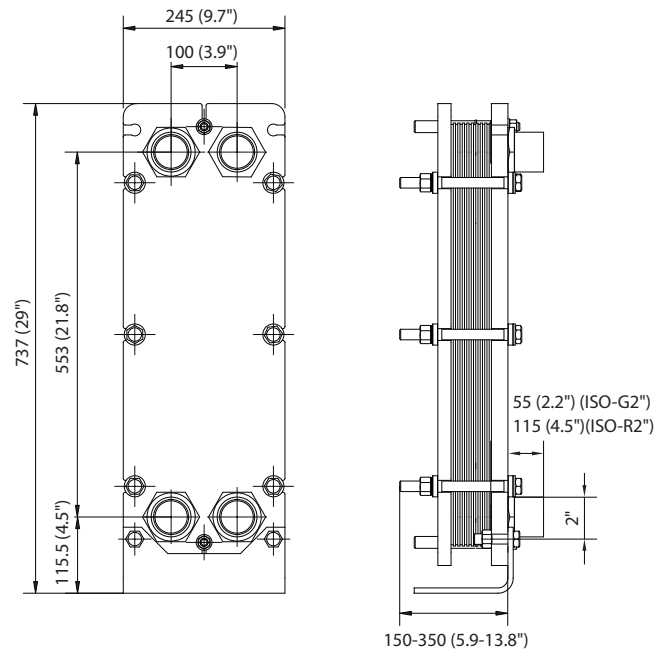

## Measurements mm (inch)

H	W	h
737 (29.0")	245 (9.6")	115.5 (4.5")

## Particulars required for quotation

- Flow rates or heat load
- Temperature program
- Physical properties of liquids in question (if not water)
- Desired working pressure
- Maximum permitted pressure drop

The thermal performance is third party certified through the AHRI Liquid to Liquid Heat Exchangers certification program



### How to contact Alfa Laval

Up-to-date AlfaLaval contact details for all countries are always available on our website on [www.alfalaval.com](http://www.alfalaval.com)



## Alfa Laval AQ2

### AlfaQ™ AHRI-certified plate heat exchanger

#### Applications

General heating and cooling duties. Heating by means of steam.

#### Standard design

The plate heat exchanger consists of a pack of corrugated metal plates with portholes for the passage of the two fluids between which heat transfer will take place.

The plate pack is assembled between a fix frame plate and a movable pressure plate and compressed by tightening bolts. The plates are fitted with a gasket which seals the interplate channel and directs the fluids into alternate channels. The number of plates is determined by the flow rate, physical properties of the fluids, pressure drop and temperature program. The plate corrugations promote fluid turbulence and support the plates against differential pressure.

The frame plate and the pressure plate are suspended from an upper carrying bar and located by a lower guiding bar, both of which are fixed to a support column.

Connections are located in the frame plate or, if either or both fluids make more than a single pass within the unit, in the frame and pressure plates.

#### Typical capacities

##### Liquid flow rate

Up to 16 kg/s (250 gpm), depending on media, permitted pressure drop and temperature program.

##### Water heating by steam

300 to 800 kW

##### Plate types

AQ2, AQ2M and AQ2MD

##### Frame types

FM, FG and FD

#### Working principle

Channels are formed between the plates and the corner ports are arranged so that the two media flow through alternate channels. The heat is transferred through the plate between the channels, and complete counter-current flow is created for highest possible efficiency. The corrugation of the plates provides the passage between the plates, supports each plate against the adjacent one and enhances the turbulence, resulting in efficient heat transfer.

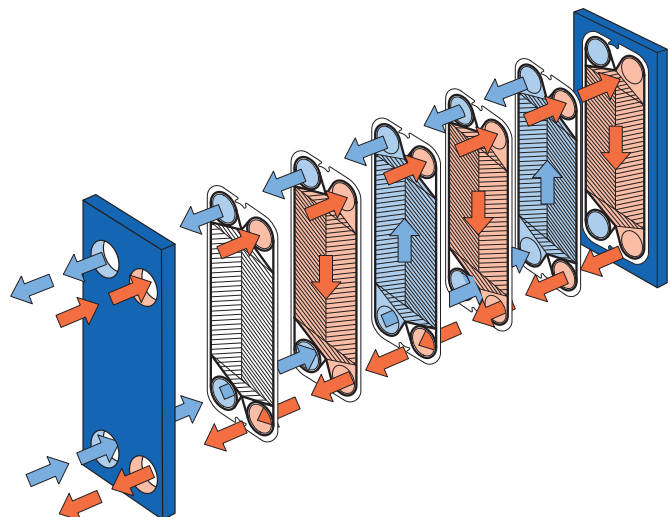

Flow principle of a plate heat exchanger

## STANDARD MATERIALS

### Frame plate

Mild steel, Epoxy painted

### Nozzles

Carbon steel

Metal lined: Stainless steel, Titanium, Alloy 254 SMO, Alloy C276

Rubber lined: Nitrile, EPDM

### Plates

Stainless steel: Alloy 316, Alloy 304. Alloy 254 SMO, Alloy C276, Titanium

### Gaskets

Nitrile, EPDM, Viton®

Other grades and material available on request.

## TECHNICAL DATA

### Pressure vessel codes, PED, ASME, pvcALS™

#### Mechanical design pressure (g) / temperature

FM	pvcALS™	1.0 MPa / 180°C
FG	PED	1.6 MPa / 180°C
FG	ASME	162 psig / 482°F
FG	pvcALS™	1.6 MPa / 180°C
FD	PED, pvcALS™	2.5 MPa / 180°C
FD	ASME	351 psig / 482°F

## Connections

### Pipe connections (not for frame type FD)

	Size:	
Straight threaded	50 mm	ISO G2"
Tapered threaded	50 mm	ISO R2", NPT2"
Straight weld	50 mm	
Threaded inlet port	50 mm	ISO G2"
Grooved pipe	50 mm	2"

### Flange connections

	Size:	
FM	pvcALS™	50 mm DIN/GB/GOST PN10, ASME Cl. 150, JIS 10K
FG	PED	50 mm DIN PN16, ASME Cl. 150
FG	ASME	2" ASME Cl. 150
FG	pvcALS™	50 mm DIN/GB/GOST PN16, ASME Cl. 150, JIS 16K
FD	PED	50 mm DIN PN25, ASME Cl. 300
FD	ASME	2" ASME Cl. 300
FD	ALS	50 mm DIN, GB, GOST PN25, JIS 20K

## Dimensions

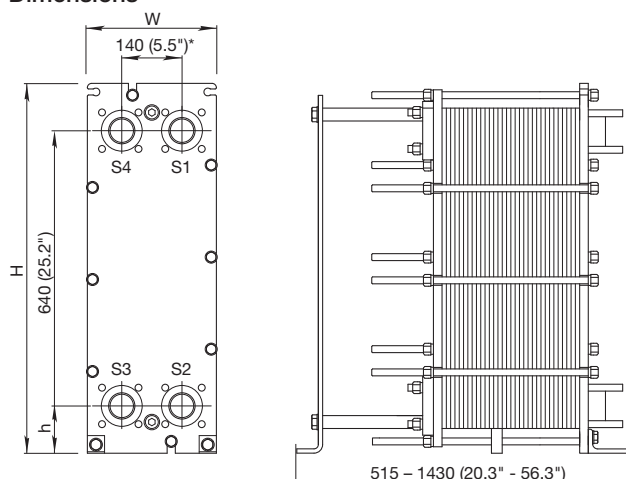

\* Displacement of some connection types occur.

### Measurements mm (inch)

Type	H	W	h
AQ2-FM	920 (36.2")	320 (12.6")	140 (5.5")
AQ2-FG	920 (36.2")	320 (12.6")	140 (5.5")
AQ2-FD	940 (37.0")	330 (13.0")	150 (5.9")

The number of tightening bolts may vary depending on pressure rating.

### Maximum heat transfer surface

38 m<sup>2</sup> (400 sq. ft)

### Particulars required for quotation

- Flow rates or heat load
- Temperature program
- Physical properties of liquids in question (if not water)
- Desired working pressure
- Maximum permitted pressure drop
- Available steam pressure

The thermal performance is third party certified through the AHRI Liquid to Liquid Heat Exchangers certification program



### How to contact Alfa Laval

Up-to-date AlfaLaval contact details for all countries are always available on our website on [www.alfalaval.com](http://www.alfalaval.com)



# Alfa Laval AQ2L

## AlfaQ™ AHRI-certified plate heat exchanger

### Applications

General heating and cooling duties.

### Standard design

The plate heat exchanger consists of a pack of corrugated metal plates with portholes for the passage of the two fluids between which heat transfer will take place.

The plate pack is assembled between a fix frame plate and a movable pressure plate and compressed by tightening bolts. The plates are fitted with a gasket which seals the interplate channel and directs the fluids into alternate channels. The number of plates is determined by the flow rate, physical properties of the fluids, pressure drop and temperature program. The plate corrugations promote fluid turbulence and support the plates against differential pressure.

The plate and the pressure plate are suspended from an upper carrying bar and located by a lower guiding bar, both of which are fixed to a support column.

Connections are located in the frame plate or, if either or both fluids make more than a single pass within the unit, in the frame and pressure plates.

### Typical capacities

#### Liquid flow rate

Up to 20 kg/s (317 gpm), depending on media, permitted pressure drop and temperature program.

### Plate types

AQ2L

### Frame types

FM, FG and FD

### Working principle

Channels are formed between the plates and the corner ports are arranged so that the two media flow through alternate channels. The heat is transferred through the plate between the channels, and complete counter-current flow is created for highest possible efficiency. The corrugation of the plates provides the passage between the plates, supports each plate against the adjacent one and enhances the turbulence, resulting in efficient heat transfer.

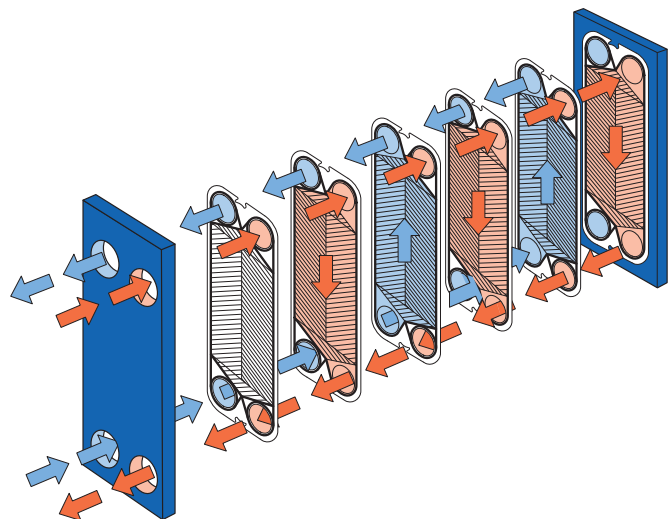

Flow principle of a plate heat exchanger



## STANDARD MATERIALS

### Frame plate

Mild steel, Epoxy painted

### Nozzles

Carbon steel

Metal lined: Stainless steel, Titanium

Rubber lined: Nitrile, EPDM

Pipe: Stainless steel

### Plates

Stainless steel Alloy 316 / Alloy 304, Titanium, Alloy 254 SMO, Alloy C276

### Gaskets

Nitrile, EPDM, Viton®

Other grades and material available on request

## TECHNICAL DATA

### Pressure vessel codes, PED, ASME, pvcALS™

### Mechanical design pressure (g) / temperature

FM	pvcALS™	1.0 MPa / 180°C
FM	PED	1.0 MPa / 180°C
FG	pvcALS™	1.6 MPa / 180°C
FG	PED	1.6 MPa / 180°C
FG	ASME	150 psig / 482°F
FD	pvcALS™	2.5 MPa / 180°C
FD	PED	2.5 MPa / 180°C
FD	ASME	300 psig / 482°F

## Connections

### Pipe connections (not for frame type FD)

Straight threaded	Size 50 mm	ISO G2", NPT 2"
Threaded inlet port	Size 50 mm	ISO G2"

### Flange connections

	Size:	
FM pvcALS™	50/65 mm	DIN/GB/GOST PN16, ASME Cl.150, JIS 10K
FM PED	50/65 mm	DIN PN16, ASME Cl. 150
FG pvcALS™	50/65 mm	DIN/GB/GOST PN16, ASME Cl. 150, JIS 10K, JIS 16K
FG PED	50/65 mm	DIN PN16, ASME Cl. 150
FG ASME	2-2½" in	ASME Cl.150
FD pvcALS™	50/65 mm	DIN/GB/GOST PN40, ASME Cl.300, JIS 20K
FD PED	50/65 mm	DIN PN40, ASME Cl. 300
FD ASME	2-2½" in	ASME Cl. 300

## Dimensions

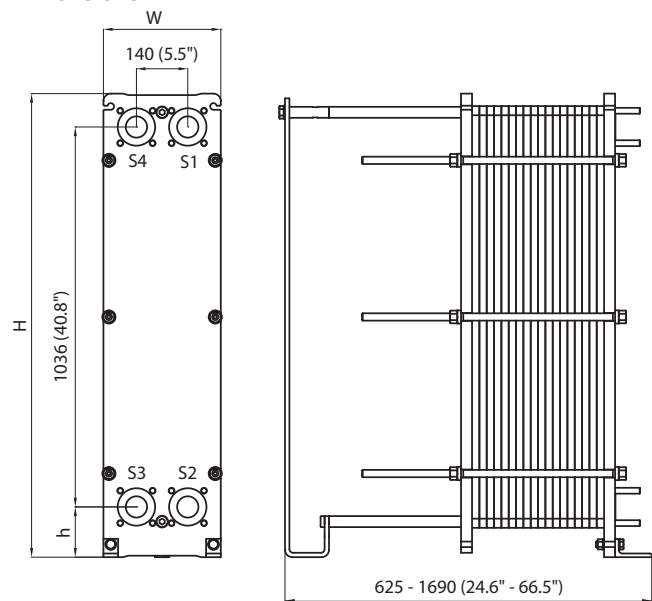

## Measurements mm (inch)

Type	H	W	h
AQ2L-FM / PED / pvcALS™	1264 (49.8")	320 (12.6")	137 (5.4")
AQ2L-FG / PED / pvcALS™	1264 (49.8")	320 (12.6")	137 (5.4")
AQ2L-FG / ASME	1299 (51.1")	320 (12.6")	142 (5.6")
AQ2L-FD / PED / pvcALS™	1264 (49.8")	330 (13.0")	137 (5.4")
AQ2L-FD / ASME	1308 (51.5")	330 (13.0")	142 (5.6")

The number of tightening bolts may vary depending on pressure rating.

## Maximum heat transfer surface

102.0 m<sup>2</sup> (1097 sq.ft)

## Particulars required for quotation

- Flow rates or heat load
- Temperature program
- Physical properties of liquids in question (if not water)
- Desired working pressure
- Maximum permitted pressure drop

The thermal performance is third party certified through the AHRI Liquid to Liquid Heat Exchangers certification program



ECF00365EN 1506

Alfa Laval reserves the right to change specifications without prior notification.

## How to contact Alfa Laval

Up-to-date AlfaLaval contact details for all countries are always available on our website on [www.alfalaval.com](http://www.alfalaval.com)



# Alfa Laval AQ2S

## AlfaQ™ AHRI-certified plate heat exchanger

### Applications

General heating and cooling duties. Heating by means of steam.

### Standard design

The plate heat exchanger consists of a pack of corrugated metal plates with portholes for the passage of the two fluids between which heat transfer will take place.

The plate pack is assembled between a fix frame plate and a movable pressure plate and compressed by tightening bolts. The plates are fitted with a gasket which seals the interplate channel and directs the fluids into alternate channels. The number of plates is determined by the flow rate, physical properties of the fluids, pressure drop and temperature program. The plate corrugations promote fluid turbulence and support the plates against differential pressure.

The plate and the pressure plate are suspended from an upper carrying bar and located by a lower guiding bar, both of which are fixed to a support column.

Connections are located in the frame plate or, an additional auxiliary connection for steam may be mounted on the pressure plate to handle high capacities.

### Typical capacities

#### Liquid flow rate

Up to 20 kg/s (300 gpm), depending on media, permitted pressure drop and temperature program.

#### Water heating by steam

200-1800 kW

#### Plate types

AQ2S

#### Frame types

FG and FD

### Working principle

Channels are formed between the plates and the corner ports are arranged so that the two media flow through alternate channels. The heat is transferred through the plate between the channels, and complete counter-current flow is created for highest possible efficiency. The corrugation of the plates provides the passage between the plates, supports each plate against the adjacent one and enhances the turbulence, resulting in efficient heat transfer.

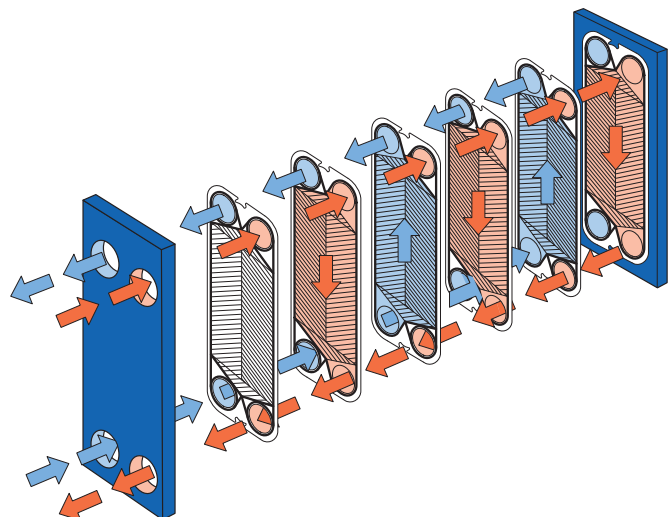

Flow principle of a plate heat exchanger

## STANDARD MATERIALS

### Frame plate

Mild steel, Epoxy painted

### Nozzles

Carbon steel

Metal lined: Stainless steel, Titanium

### Plates

Stainless steel Alloy 316, Titanium

### Gaskets

Nitrile, EPDM, Viton®

Other grades and material available on request.

## TECHNICAL DATA

### Pressure vessel codes, PED, ASME, pvcALS™

#### Mechanical design pressure (g) / temperature

FG	PED	1.6 MPa / 180°C *)
FG	pvcALS™	1.6 MPa / 180°C
FG	ASME	207 psig / 482°F
FD	PED	2.5 MPa / 180°C
FD	ASME	300 psig / 482°F

\*) Frame FG also approved for 1.2 MPa / 200°C to allow use in steam systems without safety valves.

### Connections

	Size:	
FG PED	DN65, NPS 3	DIN PN16, ASME Cl. 150
FG pvcALS™	DN65, NPS 3, 65A	DIN/GB/GOST PN16, JIS 10 K, JIS 16 K
FG ASME	NPS 3	ASME Cl. 150
FD PED	DN65, NPS 2½	DIN PN25, ASME Cl. 300
FD pvcALS™	DN65, NPS 2½, 65A	DIN/GB/GOST PN25, JIS 10 K, JIS 20 K
FD ASME	NPS 2½"	ASME Cl. 300

## Dimensions

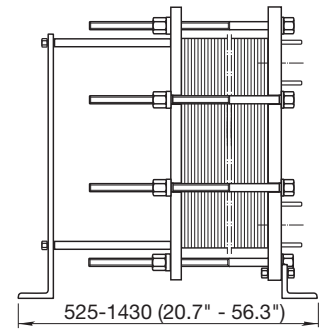
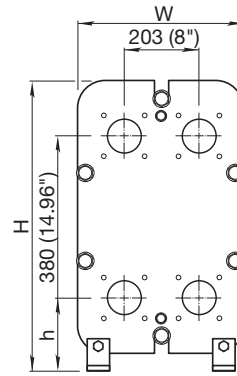

## Measurements mm (inch)

Type	H	W	h
AQ2S-FG	704 (27.7")	400 (15.7")	188 (7.4")
AQ2S-FD	704 (27.7")	410 (16.1")	188 (7.4")

The number of tightening bolts may vary depending on pressure rating.

## Maximum heat transfer surface

13 m<sup>2</sup> (140 sq. ft)

## Particulars required for quotation

- Flow rates or heat load
- Temperature program
- Physical properties of liquids in question (if not water)

The thermal performance is third party certified through the AHRI Liquid to Liquid Heat Exchangers certification program



### How to contact Alfa Laval

Up-to-date AlfaLaval contact details for all countries are always available on our website on [www.alfalaval.com](http://www.alfalaval.com)



# Alfa Laval AQ3

## AlfaQ™ AHRI-certified plate heat exchanger

### Application

The Alfa Laval industrial line of plate heat exchangers is well suited for a wide range of heating and cooling duties.

### Benefits

- High serviceability - Easy to open
- Compact design
- Easy to install
- Flexible heat transfer area configuration
- High energy efficiency - Low operating cost

### Design

The plate heat exchanger consists of a package of corrugated metal plates with portholes for the passage of the two fluids between which heat transfer will take place.

The number of plates is determined by the flow rates, physical properties of the fluids, pressure drops and temperature program. The plate corrugations promote fluid turbulence and support the plates against differential pressure.

The materials of gaskets are selected for safe use depending on media type and temperature. The attachment of the gasket rings is glue-free, which makes them easy to replace even with the plates still hanging in the frame.

The carrying bar and guiding bar are fixed to the stationary frame plate and the supporting column. The pressure plate and plate package is movable along the upper carrying bar and located by the lower guiding bar. Connections are located in the frame plate. Depending on the application, connections can also be located in the pressure plate.



### Working principle

Channels are formed between the plates and the corner ports are arranged so that the two media flow through alternate channels. The heat is transferred through the plates between the channels. Complete counter-current or co-current flow, depending on the application, is created for highest possible efficiency. The corrugation of the plates provides the passage between the plates, supports each plate against the adjacent one and enhances the turbulence, resulting in efficient heat transfer.

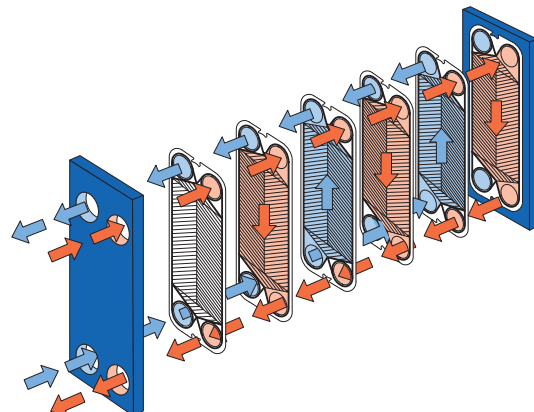

Flow principle of a plate heat exchanger.



## STANDARD MATERIALS

### Frame plate

Mild steel, epoxy painted

### Connections

Metal lined: Stainless steel and Titanium.

Rubber lined: Nitrile (FM only)

### Plates

Stainless steel Alloy 304, Alloy 316 and Titanium

### Gaskets

Field gaskets: Nitrile, EPDM

Ring gaskets: Nitrile, EPDM

Other grades and materials available upon request.

## TECHNICAL DATA

### Design pressure (g)

FM	pvcALS™	1.034 MPa
FM	PED	1.034 MPa
FG	pvcALS™	1.60 MPa
FG	PED	1.60 MPa
FG	ASME	150 psi

### Design temperature

Determined by gasket material.

### Plate types

AQ3-B and AQ3-M

### Connection size

DN80 / NPS 3 / 80A

### Maximum heat transfer surface

35 m<sup>2</sup> (377 sqft)

### Maximum liquid flow rates

Up to 30 kg/s (475 gpm), depending on media, permitted pressure drop and temperature program.

## Connection standard

FM	pvcALS™	EN 1092-1 PN10, ASME B16.5 Class 150, JIS B2220 10K
FM	PED	EN 1092-1 PN10, ASME B16.5 Class 150
FG	pvcALS™	EN 1092-1 PN16 and PN10, ASME B16.5 Class 150, JIS B2220 16K and 10K
FG	PED	EN 1092-1 PN16, ASME B16.5 Class 150
FG	ASME	ASME B16.5 Class 150

Standard EN 1092-1 corresponds to GOST 12815-80 and GB/T 9115.

## Particulars required for quotation

To receive a quotation for plate heat exchangers that meet your requirements, please provide Alfa Laval representatives with:

- Flow rates or heat load
- Temperature program
- Physical properties of liquids in question (if not water)
- Design pressure and design temperature
- Maximum permitted pressure drop

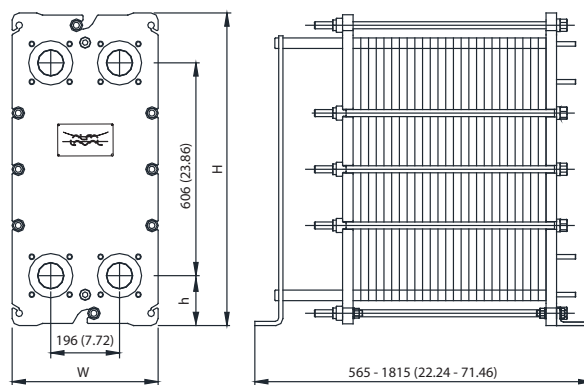

## Measurements mm (inch)

Type	H	W	h
AQ3-FM (ALS,PED,ASME)	890 (35.04)	400 (15.78)	142 (5.59)
AQ3-FG (ALS,PED)	890 (35.04)	400 (15.78)	142 (5.59)
AQ3-FG (ASME)	890 (35.04)	416 (16.38)	142 (5.59)

The number of tightening bolts may vary depending on type.

The thermal performance is third party certified through the AHRI Liquid to Liquid Heat Exchangers certification program



### How to contact Alfa Laval

Up-to-date AlfaLaval contact details for all countries are always available on our website on [www.alfalaval.com](http://www.alfalaval.com)



## Alfa Laval AQ4

### AlfaQ™ AHRI-certified plate heat exchanger

#### Applications

General heating and cooling duties. Heating by means of steam.

#### Standard design

The plate heat exchanger consists of a pack of corrugated metal plates with portholes for the passage of the two fluids between which heat transfer will take place.

The plate pack is assembled between a fix frame plate and a movable pressure plate and compressed by tightening bolts. The plates are fitted with a gasket which seals the interplate channel and directs the fluids into alternate channels. The number of plates is determined by the flow rate, physical properties of the fluids, pressure drop and temperature program. The plate corrugations promote fluid turbulence and support the plates against differential pressure.

The plate and the pressure plate are suspended from an upper carrying bar and located by a lower guiding bar, both of which are fixed to a support column.

Connections are located in the frame plate or, if either or both fluids make more than a single pass within the unit, in the frame and pressure plates.

#### Typical capacities

##### Liquid flow rate

Up to 50 kg/s (800 gpm), depending on media, permitted pressure drop and temperature program.

##### Water heating by steam

0.7 to 3.0 MW

##### Plate types

AQ4, AQ4-M and AQ4-D, double wall plates.

##### Frame types

FM, FG and FD

#### Working principle

Channels are formed between the plates and the corner ports are arranged so that the two media flow through alternate channels. The heat is transferred through the plate between the channels, and complete counter-current flow is created for highest possible efficiency. The corrugation of the plates provides the passage between the plates, supports each plate against the adjacent one and enhances the turbulence, resulting in efficient heat transfer.

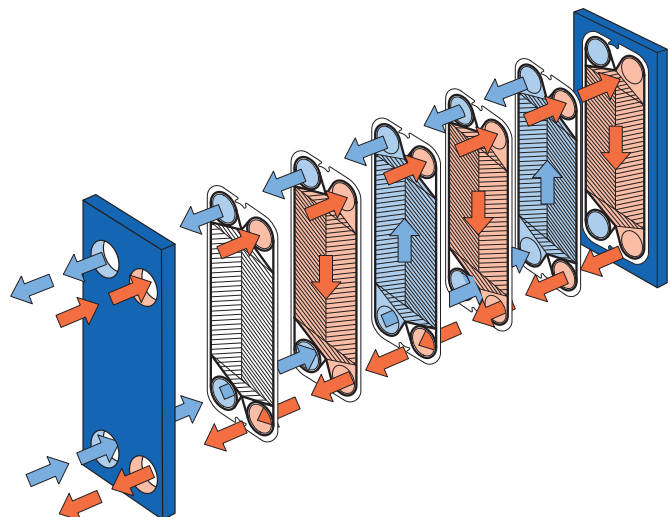

Flow principle of a plate heat exchanger

## STANDARD MATERIALS

### Frame plate

Mild steel, Epoxy painted

### Nozzles

Carbon steel

Metal lined: Stainless steel, Titanium

Rubber lined: Nitrile, EPDM

### Plates

Stainless steel Alloy 316/Alloy 304, Titanium, Alloy 254 SMO, Alloy C276

### Gaskets (Clip-on, glued)

Nitrile, EPDM, Viton®

Other grades and material available on request.

## TECHNICAL DATA

### Pressure vessel codes, PED, ASME, pvcALS™

#### Mechanical design pressure (g) / temperature

FL pvcALS™	0.6 MPa / 130°C
FM pvcALS™	1.0 MPa / 180°C
FM PED	1.0 MPa / 180°C
FG pvcALS™	1.6 MPa / 180°C
FG PED	1.6 MPa / 180°C *
FG ASME	150 psig / 356°F
FD PED pvcALS™	2.5 MPa / 180°C
FD ASME	389 psig / 482°F

\*) Frame FG also approved for 1.2 MPa / 200°C to allow use in steam systems without safety valves.

### Connections

Size: DN100 / NPS 4 / 100A

FL	pvcALS™	EN 1092-1 PN10, JIS B2220 10K
FM	pvcALS™	EN 1092-1 PN10, ASME B16.5 Class 150, JIS B2220 10K,
FM	PED	EN 1092-1 PN10, ASME B16.5 Class 150
FG	pvcALS™	EN 1092-1 PN16, ASME B16.5 Class 150, JIS B2220 10K, JIS B2220 16K,
FG	PED	EN 1092-1 PN16, ASME B16.5 Class 150
FG	ASME	ASME B16.5 Class 150
FD	PED	EN 1092-1 PN25, ASME B16.5 Class 150, ASME B16.5 Class 300
FD	ASME	ASME B16.5 Class 300

Standard EN 1092-1 corresponds to GOST 12815-80 and GB/T 9115.

## Dimensions

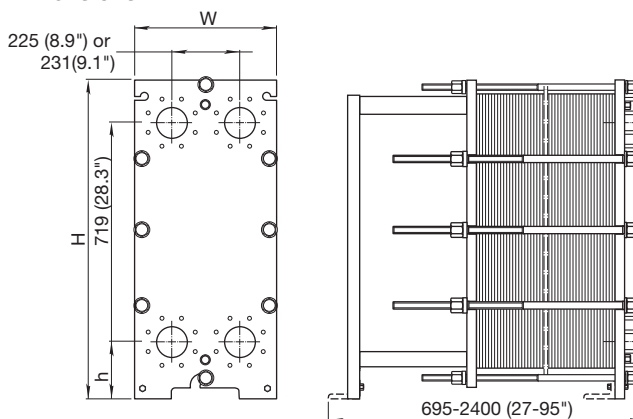

## Measurements mm (inch)

Type	H	W	h
AQ4-FM	1084 (42.7")	470 (18.5")	215 (8.5")
AQ4-FG	1084 (42.7")	470 (18.5")	215 (8.5")
AQ4-FD	981 (38.6")	470 (18.5")	131 (5.2")
AQ4-FD ASME	1084 (42.7")	470 (18.5")	215 (8.5")

The number of tightening bolts may vary depending on pressure rating.

### Maximum heat transfer surface

AQ4-B 90 m<sup>2</sup> (970 sq. ft)

AQ4 60 m<sup>2</sup> (650 sq. ft)

### Particulars required for quotation

- Flow rates or heat load
- Temperature program
- Physical properties of liquids in question (if not water)
- Desired working pressure
- Maximum permitted pressure drop
- Available steam pressure

The thermal performance is third party certified through the AHRI Liquid to Liquid Heat Exchangers certification program



### How to contact Alfa Laval

Up-to-date AlfaLaval contact details for all countries are always available on our website on [www.alfalaval.com](http://www.alfalaval.com)



# Alfa Laval AQ4L

## AlfaQ™ AHRI-certified plate heat exchanger

### Applications

General heating and cooling duties.

### Standard design

The plate heat exchanger consists of a pack of corrugated metal plates with portholes for the passage of the two fluids between which heat transfer will take place.

The plate pack is assembled between a fix frame plate and a movable pressure plate and compressed by tightening bolts. The plates are fitted with a gasket which seals the interplate channel and directs the fluids into alternate channels. The number of plates is determined by the flow rate, physical properties of the fluids, pressure drop and temperature program. The plate corrugations promote fluid turbulence and support the plates against differential pressure.

The plate and the pressure plate are suspended from an upper carrying bar and located by a lower guiding bar, both of which are fixed to a support column.

Connections are located in the frame plate or, if either or both fluids make more than a single pass within the unit, in the frame and pressure plates.

### Typical capacities

#### Liquid flow rate

Up to 50 kg/s (800 gpm), depending on media, permitted pressure drop and temperature program.

#### Plate types

AQ4L, AQ4L-P

#### Frame types

FM, FG and FS

### Working principle

Channels are formed between the plates and the corner ports are arranged so that the two media flow through alternate channels. The heat is transferred through the plate between the channels, and complete counter-current flow is created for highest possible efficiency. The corrugation of the plates provides the passage between the plates, supports each plate against the adjacent one and enhances the turbulence, resulting in efficient heat transfer.

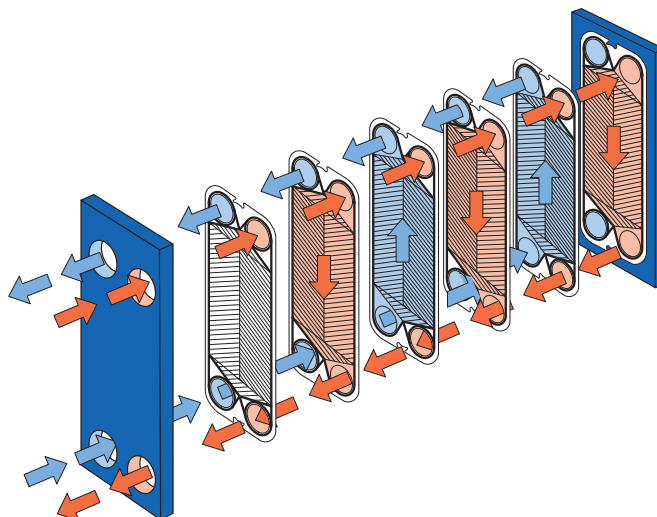
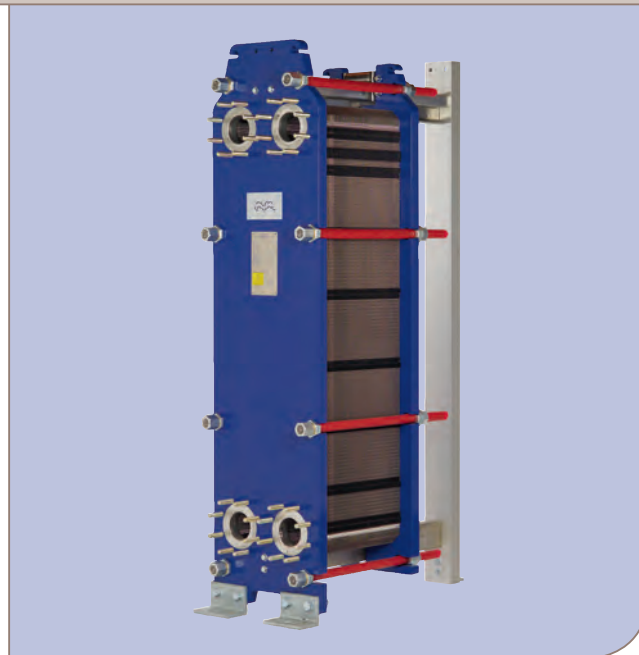

Flow principle of a plate heat exchanger



## STANDARD MATERIALS

### Frame plate

Mild steel, Epoxy painted

### Nozzles

Carbon steel

Metal lined: Stainless steel, Titanium, Alloy 254, Alloy C276, Nickel

Rubber lined: Nitrile, EPDM

### Plates

Stainless steel: Alloy 304, Alloy 316. Alloy 254, Alloy C276  
Nickel, Titanium

### Gaskets

Nitrile, EPDM, Viton®

Other grades and material available on request

## TECHNICAL DATA

### Pressure vessel codes, PED, ASME, pvcALS™

### Mechanical design pressure (g) / temperature

FM	pvcALS™	1.0 MPa / 180°C
FG	PED, pvcALS™	1.6 MPa / 180°C
FG	ASME	150 psig / 482°F
FD	PED	2.5 MPa / 180°C
FS	ASME	400 psig / 482°F

### Connections

Size: DN100 / NPS 4 / 100A

FM	pvcALS™	EN 1092-1 PN10, ASME B16.5 Class 150, JIS B2220 10K
FG	PED	EN 1092-1 PN10, ASME B16.5 Class 150
FG	pvcALS™	EN 1092-1 PN16, ASME B16.5 Class 150, JIS B2220 16K
FG	ASME	ASME B16.5 Class 150
FD	PED	EN 1092-1 PN25, ASME B16.5 Class 300, Special square flange
FD	pvcALS™	EN 1092-1 PN25, ASME B16.5 Class 150, JIS B2220 20K
FS	ASME	Special square flange

Standard EN 1092-1 corresponds to GOST 12815-80 and GB/T 9115.

### Maximum heat transfer surface

250 m<sup>2</sup> (2700 sq. ft)

## Dimensions

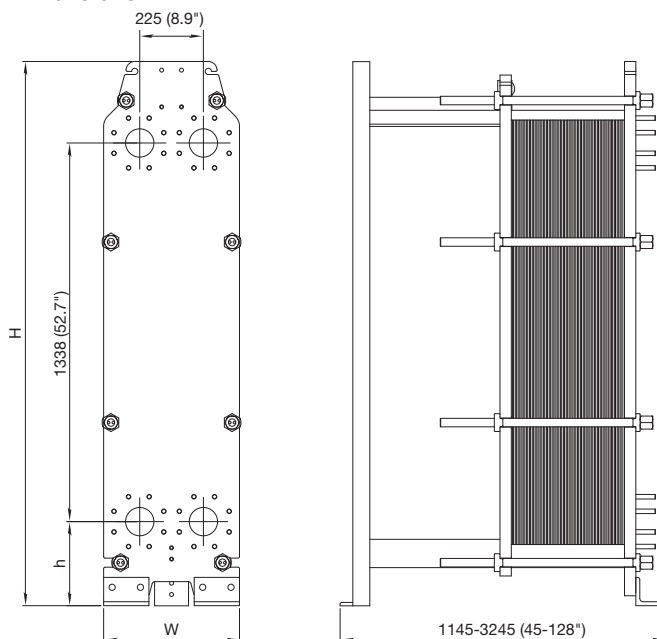

### Measurements mm (inch)

Type	H	W	h
AQ4L-FM	1885 (74.2")	480 (18.9")	255 (10")
AQ4L-FG	1981 (78")	480 (18.9")	297 (11.7")
AQ4L-FD	1981 (78")	480 (18.9")	297 (11.7")
AQ4L-FS	1981 (78")	510 (20.1")	297 (11.7")

The number of tightening bolts may vary depending on pressure rating.

### Particulars required for quotation

- Flow rates or heat load
- Temperature program
- Physical properties of liquids in question (if not water)
- Desired working pressure
- Maximum permitted pressure drop

The thermal performance is third party certified through the AHRI Liquid to Liquid Heat Exchangers certification program



### How to contact Alfa Laval

Up-to-date AlfaLaval contact details for all countries are always available on our website on [www.alfalaval.com](http://www.alfalaval.com)



## Alfa Laval AQ6

### AlfaQ™ AHRI-certified plate heat exchanger

#### Applications

General heating and cooling duties.

#### Standard design

The plate heat exchanger consists of a pack of corrugated metal plates with portholes for the passage of the two fluids between which heat transfer will take place.

The plate pack is assembled between a fix frame plate and a movable pressure plate and compressed by tightening bolts. The plates are fitted with a gasket which seals the interplate channel and directs the fluids into alternate channels. The number of plates is determined by the flow rate, physical properties of the fluids, pressure drop and temperature program. The plate corrugations promote fluid turbulence and support the plates against differential pressure.

The plate and the pressure plate are suspended from an upper carrying bar and located by a lower guiding bar, both of which are fixed to a support column.

Connections are located in the frame plate or, if either or both fluids make more than a single pass within the unit, in the frame and pressure plates.

#### Typical capacities

##### Liquid flow rate

Up to 80 kg/s (1300 gpm), depending on media, permitted pressure drop and temperature program.

##### Plate Types

AQ6, AQ6M and AQ6D, double wall plates

##### Frame types

FL, FM, FG and FD

#### Working principle

Channels are formed between the plates and the corner ports are arranged so that the two media flow through alternate channels. The heat is transferred through the plate between the channels, and complete counter-current flow is created for highest possible efficiency. The corrugation of the plates provides the passage between the plates, supports each plate against the adjacent one and enhances the turbulence, resulting in efficient heat transfer.

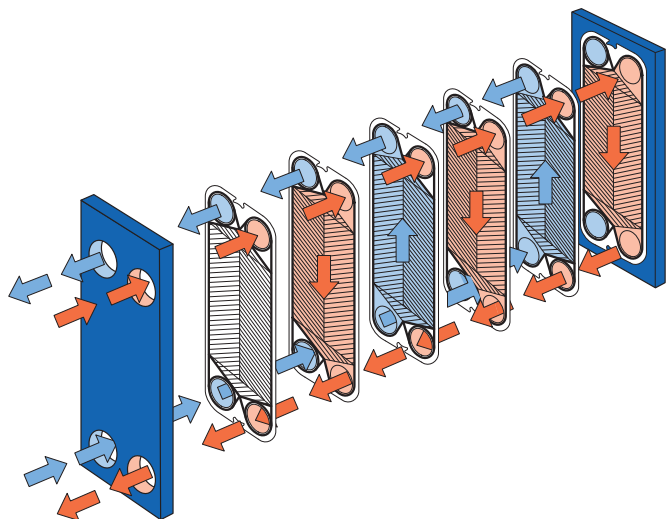

Flow principle of a plate heat exchanger

## STANDARD MATERIALS

### Frame plate

Mild steel, Epoxy painted

### Nozzles

Carbon steel

Metal lined: Stainless steel, Titanium

Rubber lined: Nitrile, EPDM

### Plates

Stainless steel: Alloy 304, Alloy 316, Alloy C276, Alloy 254 SMO, Titanium

### Gaskets (Clip-on/tape-on, glued)

Nitrile, EPDM, Viton®

Other grades and material available on request.

## TECHNICAL DATA

### Pressure vessel codes, PED, ASME, pvcALS™

### Mechanical design pressure (g) / temperature

FL	pvcALS™	0.6 MPa / 130°C
FM	PED, pvcALS™	1.0 MPa / 180°C
FG	PED, pvcALS™	1.6 MPa / 180°C
FG	ASME	170 psig / 482°F
FD	PED, pvcALS™	3.0 MPa / 180°C
FD	ASME	300 psig / 356°F

## Connections

Size: DN150 / NPS 6 / 150A

FL	pvcALS™	EN 1092-1 PN10, JIS B2220 10K
FM	PED	DIN PN10, ASME B16.5 Class 150
FM	pvcALS™	DIN PN10, ASME B16.5 Class 150, JIS B2220 10K
FG	PED	DIN PN16, ASME B16.5 Class 150
FG	pvcALS™	DIN PN16, ASME B16.5 Class 150, JIS B2220 16K
FG	ASME	ASME B16.5 Class 150
FD	PED	DIN PN25, ASME B16.5 Class 300
FD	ASME	ASME B16.5 Class 300

Standard EN 1092-1 corresponds to GOST 12815-80 and GB/T 9115.

## Maximum heat transfer surface

390 m<sup>2</sup> (4200 sq. ft)

## Dimensions

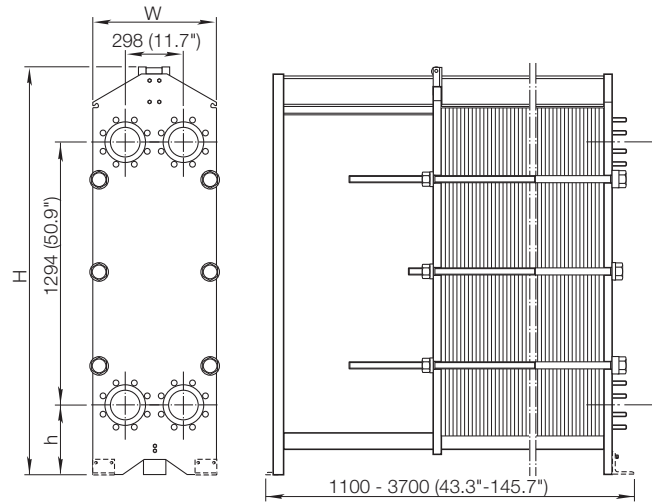

## Measurements mm (inch)

Type	H	W	h
AQ6-FL	1815 (71.5")	610 (24")	275 (10.8")
AQ6-FM	max. 1941 (76.4")	610 (24")	275 (10.8")
AQ6-FG	max. 1941 (76.4")	650 (25.6")	275 (10.8")
AQ6-FD	max. 2036 (80.2")	650 (25.6")	370 (14.6")

The number of tightening bolts may vary depending on pressure rating.

## Particulars required for quotation

- Flow rates or heat load
- Temperature program
- Physical properties of liquids in question (if not water)
- Desired working pressure
- Maximum permitted pressure drop
- Available steam pressure

The thermal performance is third party certified through the AHRI Liquid to Liquid Heat Exchangers certification program



## How to contact Alfa Laval

Up-to-date AlfaLaval contact details for all countries are always available on our website on [www.alfalaval.com](http://www.alfalaval.com)



## Alfa Laval AQ6L

### AlfaQ™ AHRI-certified plate heat exchanger

#### Applications

General heating and cooling duties.

#### Standard design

The plate heat exchanger consists of a pack of corrugated metal plates with portholes for the passage of the two fluids between which heat transfer will take place.

The plate pack is assembled between a fix frame plate and a movable pressure plate and compressed by tightening bolts. The plates are fitted with a gasket which seals the interplate channel and directs the fluids into alternate channels. The number of plates is determined by the flow rate, physical properties of the fluids, pressure drop and temperature program. The plate corrugations promote fluid turbulence and support the plates against differential pressure.

The plate and the pressure plate are suspended from an upper carrying bar and located by a lower guiding bar, both of which are fixed to a support column.

Connections are located in the frame plate or, if either or both fluids make more than a single pass within the unit, in the frame and pressure plates.

#### Typical capacities

##### Liquid flow rate

Up to 120 kg/s (1900 gpm), depending on media, permitted pressure drop and temperature program.

#### Plate types

AQ6L

#### Frame types

FM, FG, FD and FS

#### Working principle

Channels are formed between the plates and the corner ports are arranged so that the two media flow through alternate channels. The heat is transferred through the plate between the channels, and complete counter-current flow is created for highest possible efficiency. The corrugation of the plates provides the passage between the plates, supports each plate against the adjacent one and enhances the turbulence, resulting in efficient heat transfer.

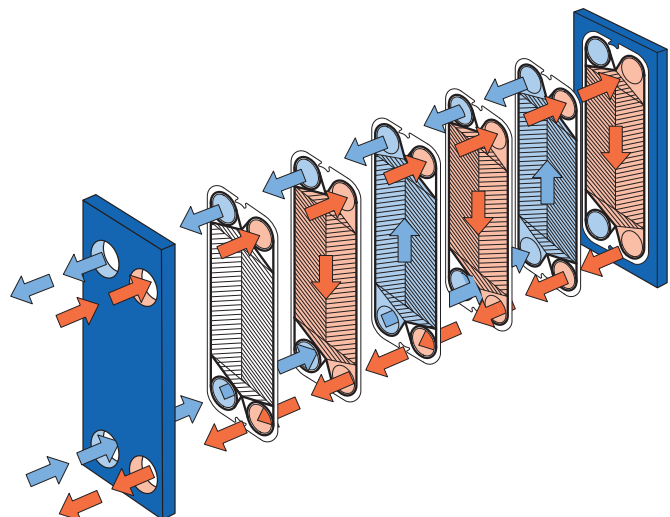

Flow principle of a plate heat exchanger



## STANDARD MATERIALS

### Frame plate

Mild steel, Epoxy painted

### Nozzles

Carbon steel

Metal lined: Stainless steel, Titanium

Rubber lined: Nitrile, EPDM

### Plates

Stainless steel: Alloy 304, Alloy 316. Titanium

### Gaskets

Nitrile, EPDM

## TECHNICAL DATA

### Pressure vessel codes, PED, ASME, pvcALS™

### Mechanical design pressure (g) / temperature\*

FM	pvcALS™	1.0 MPa / 180°C
FG	pvcALS™	2.0 MPa / 50°C
FG	PED	2.0 MPa / 50°C
FG	ASME	150 psig / 482°F
FD	ASME	300 psig / 482°F
FS	pvcALS™	3.5 MPa / 50°C
FS	PED	3.5 MPa / 50°C
FS	ASME	460 psig / 482°F

\* All PED and ALS units, except FM, are optimised for a design temperature of 50°C (122°F).

All PED and ALS units are also available for of multi range temperatures 50, 100, 150, 180 and 200°C with corresponding lower design pressure.

## Connections

Size: DN150 / NPS 6 / 150A

FM	pvcALS™	EN 1092-1 PN10, ASME B16.5 Class 150, JIS B2220 10K
FG	pvcALS™	DIN/GB/GOST PN16, PN25, ASME Cl. 150, JIS 10K, JIS 16K
FG	PED	EN 1092-1 PN16, EN 1092-1 PN25, ASME B16.5 Class 150
FG	ASME	ASME B16.5 Class 150
FD	ASME	ASME B16.5 Class 300
FS	pvcALS™	EN 1092-1 PN25, EN 1092-1 PN40, ASME B16.5 Class 300 JIS 10K, JIS 20K
FS	PED	EN 1092-1 PN25, EN 1092-1 PN40, ASME B16.5 Class 300
FS	ASME	ASME B16.5 Class 300

Standard EN 1092-1 corresponds to GOST 12815-80 and GB/T 9115.

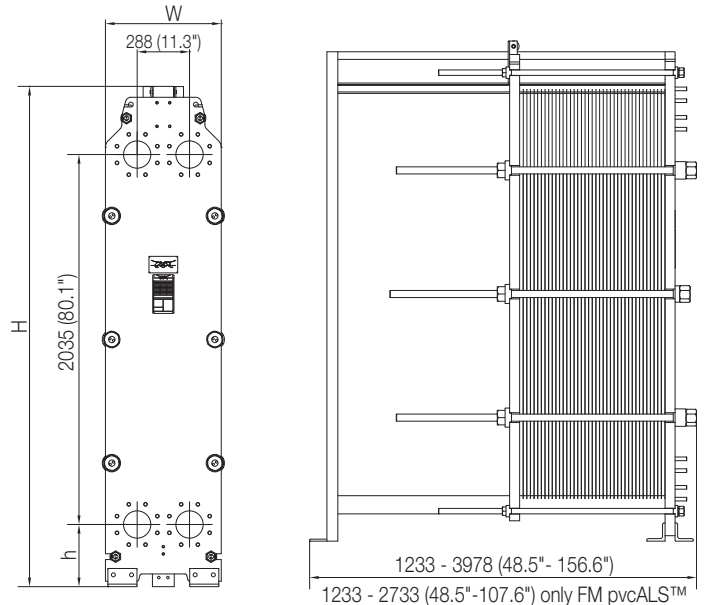

## Measurements mm (inch)

Type	H	W	h
AQ6L-FM/pvcALS™	2752 (108.3")	610 (24.0")	342 (13.5")
AQ6L-FG/PED/pvcALS™	2752 (108.3")	637 (25.1")	342 (13.5")
AQ6L-FG/ASME	2752 (108.3")	646 (25.4")	342 (13.5")
AQ6L-FD/ASME	2752 (108.3")	646 (25.4")	342 (13.5")
AQ6L-FS/PED/pvcALS™	2752 (108.3")	646 (25.4")	342 (13.5")
AQ6L-FS/ASME	2752 (108.3")	646 (25.4")	342 (13.5")

The number of tightening bolts may vary depending on pressure rating and Pressure Vessel Code (PVC) requirements.

## Maximum heat transfer surface

990 (1.1 x 900) m<sup>2</sup> (10660 sq.ft)

## Particulars required for quotation

- Flow rates or heat load
- Temperature program
- Physical properties of liquids in question (if not water)
- Desired working pressure
- Maximum permitted pressure drop
- Available steam pressure

The thermal performance is third party certified through the AHRI Liquid to Liquid Heat Exchangers certification program



## How to contact Alfa Laval

Up-to-date AlfaLaval contact details for all countries are always available on our website on [www.alfalaval.com](http://www.alfalaval.com)



# Alfa Laval AQ8S

## AlfaQ™ AHRI-certified plate heat exchanger

### Applications

General heating and cooling duties. Heating by means of steam.

### Standard design

The plate heat exchanger consists of a pack of corrugated metal plates with portholes for the passage of the two fluids between which heat transfer will take place.

The plate pack is assembled between a fix frame plate and a movable pressure plate and compressed by tightening bolts. The plates are fitted with a gasket which seals the interplate channel and directs the fluids into alternate channels. The number of plates is determined by the flow rate, physical properties of the fluids, pressure drop and temperature program. The plate corrugations promote fluid turbulence and support the plates against differential pressure.

The plate and the pressure plate are suspended from an upper carrying bar and located by a lower guiding bar, both of which are fixed to a support column.

Connections are located in the frame plate or, if either or both fluids make more than a single pass within the unit, in the frame and pressure plates.

### Typical capacities

#### Liquid flow rate

Up to 190 kg/s (3040 gpm), depending on media, permitted pressure drop and temperature program.

#### Water heating by steam

2.5-15 MW at a steam condensation temperature of 150°C  
2.5-9 MW at a steam condensation temperature of 120°C

### Plate types

AQ8S plates

### Frame types

FM, FG and FS

### Working principle

Channels are formed between the plates and the corner ports are arranged so that the two media flow through alternate channels. The heat is transferred through the plate between the channels, and complete counter-current flow is created for highest possible efficiency. The corrugation of the plates provides the passage between the plates, supports each plate against the adjacent one and enhances the turbulence, resulting in efficient heat transfer.

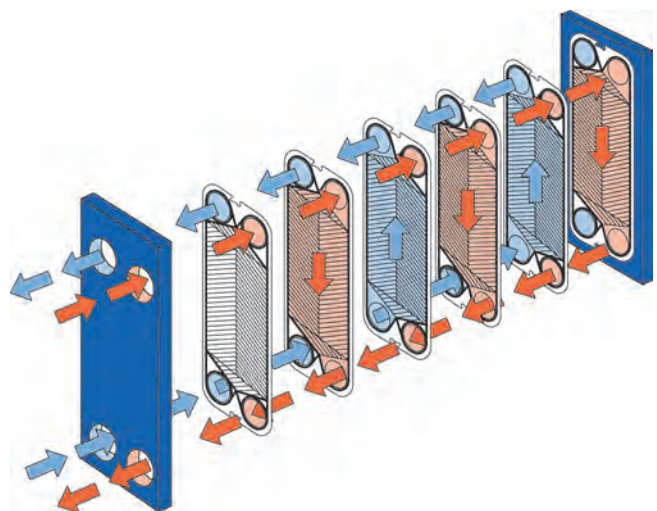

## STANDARD MATERIALS

### Frame plate

Mild steel, Epoxy painted

### Nozzles

Carbon steel

Metal lined: Stainless steel, Titanium, Alloy C-276

Rubber lined: Nitrile, EPDM

### Plates

Stainless steel Alloy 316 (Alloy 254, Alloy C-276 or Titanium

Other grades and material available on request.

### Gaskets

Nitrile, EPDM, Viton or HeatSealF™

Other grades and material available on request.

## TECHNICAL DATA

### Pressure vessel codes, PED, ASME, pvcALS™

#### Mechanical design pressure (g) / temperature

FM	PED	10 MPa / 210°C
FM	pvcALS™	1.0 MPa / 180°C
FG	PED	1.6 MPa / 180°C *)
FG	ASME	150 psig / 350°F
FG	pvcALS™	1.6 MPa / 180°C
FS	PED	3.0 MPa / 160°C
FS	ASME	460 psig / 350°F

\*) Frame FG also approved for 1.2 MPa / 200°C to allow use in steam systems without safety valves.

### Connections

Size: DN200 / NPS 8 / 200A

FM	PED	EN 1092-1 PN10, ASME B16.5 Class 150
FM	pvcALS™	EN 1092-1 PN10, ASME B16.5 Class 150, JIS B2220 10K
FG	PED	EN 1092-1 PN16, ASME B16.5 Class 150
FG	ASME	ASME B16.5 Class 150
FG	pvcALS™	EN 1092-1 PN10, ASME B16.5 Class 150, JIS B2220 10K, JIS B2220 16K
FS	PED	EN 1092-1 PN25, EN 1092-1 PN40, ASME Cl. 300
FS	ASME	ASME B16.5 Class 150, ASME B16.5 Class 300

Standard EN 1092-1 corresponds to GOST 12815-80 and GB/T 9115.

## Dimensions

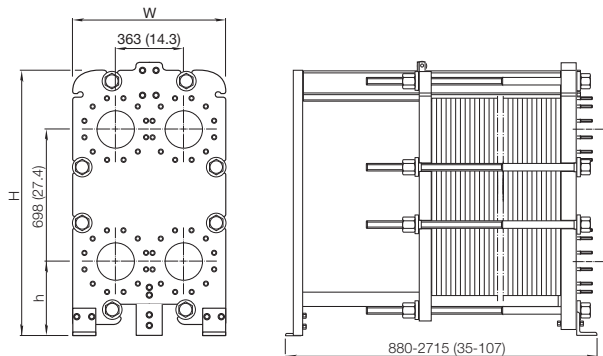

## Measurements mm (inch)

Type	H	W	h
AQ8S-FM	1405 (55 <sup>5</sup> / <sub>16</sub> )	740 (29 <sup>1</sup> / <sub>8</sub> )	360 (14 <sup>1</sup> / <sub>8</sub> )
AQ8S-FG	1405 (55 <sup>5</sup> / <sub>16</sub> )	800 (31 <sup>1</sup> / <sub>2</sub> )	360 (14 <sup>1</sup> / <sub>8</sub> )
AQ8S-FS	1435 (56 <sup>1</sup> / <sub>2</sub> )	800 (31 <sup>1</sup> / <sub>2</sub> )	390 (14 <sup>3</sup> / <sub>8</sub> )

The number of tightening bolts may vary depending on pressure rating.

## Maximum heat transfer surface

85 m<sup>2</sup> (910 sq. ft)

## Particulars required for quotation

- Flow rates or heat load
- Temperature program
- Physical properties of liquids in question (if not water)
- Desired working pressure
- Maximum permitted pressure drop
- Available steam pressure

The thermal performance is third party certified through the AHRI Liquid to Liquid Heat Exchangers certification program



### How to contact Alfa Laval

Up-to-date AlfaLaval contact details for all countries are always available on our website on [www.alfalaval.com](http://www.alfalaval.com)



# Alfa Laval AQ8

## AlfaQ™ AHRI-certified plate heat exchanger

### Applications

General heating and cooling duties

### Standard design

The plate heat exchanger consists of a pack of corrugated metal plates with portholes for the passage of the two fluids between which heat transfer will take place.

The plate pack is assembled between a fix frame plate and a movable pressure plate and compressed by tightening bolts. The plates are fitted with a gasket, which seals the interplate channel and directs the fluids into alternate channels. The number of plates is determined by the flow rate, physical properties of the fluids, pressure drop and temperature program. The plate corrugations promote fluid turbulence and support the plates against differential pressure.

The frame plate and the pressure plate are suspended from an upper carrying bar and located by a lower guiding bar, both of which are fixed to a support column.

Connections are located in the frame plate or, if either or both fluids make more than a single pass within the unit, in the frame and pressure plates.

### Typical capacities

#### Liquid flow rate

Up to 225 kg/s (3600 gpm), depending on media, permitted pressure drop and temperature program.

Plate types

AQ8, AQ8M and AQ8P plates

#### Frame types

FM, FG and FS

### Working principle

Channels are formed between the plates and the corner ports are arranged so that the two media flow through alternate channels. The heat is transferred through the plate between the channels, and complete counter-current flow is created for highest possible efficiency. The corrugation of the plates provides the passage between the plates, supports each plate against the adjacent one and enhances the turbulence, resulting in efficient heat transfer.

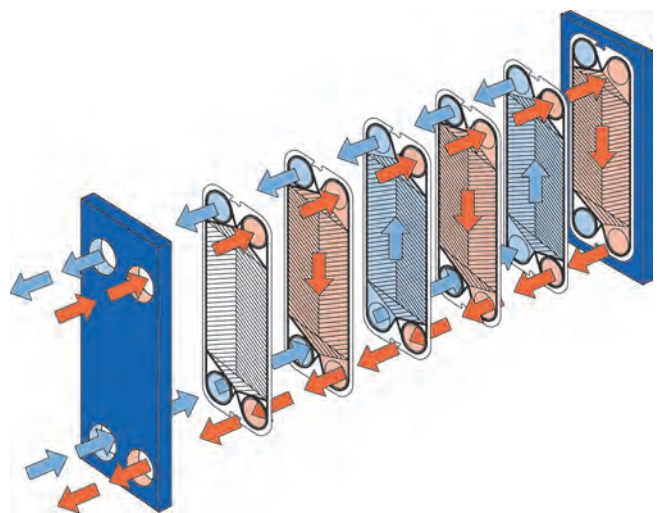
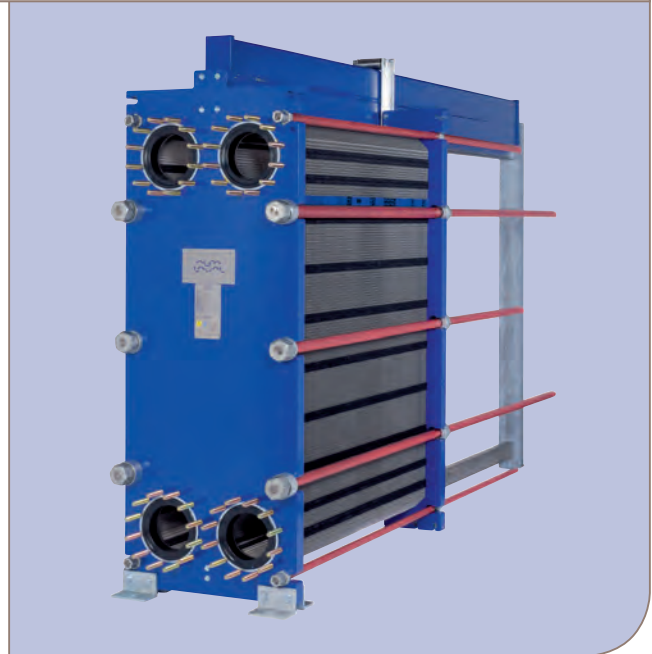

Flow principle of a plate heat exchanger



## STANDARD MATERIALS

### Frame plate

Mild steel, Epoxy painted

### Nozzles

Rubber lined

Carbon steel

Metal lined: Stainless steel, Titanium, Alloy C-276

### Plates

Stainless steel Alloy 304, Stainless steel Alloy 316, Alloy 254 SMO, Alloy C-276 or Titanium Other grades and material available on request.

### Gaskets

Nitrile, EPDM or Viton

Other grades and material available on request.

## TECHNICAL DATA

### Mechanical design pressure (g) / temperature

FM	pvcALS™	1.0 MPa / 180°C
FG	pvcALS™	1.6 MPa / 180°C
FG	PED	1.6 MPa / 180°C
FG	ASME	150 psig / 480°F
FD	ASME	300 psig / 480°F
FS	PED	3.0 MPa / 160°C
FS	ASME	400 psig / 480°F

## CONNECTIONS

Size: DN200 / NPS 8 / 200A

FM	pvcALS™	EN 1092-1 PN10, ASME B16.5 Class 150, JIS B2220 10K
FG	pvcALS™	EN 1092-1 PN16, ASME B16.5 Class 150, JIS B2220 10K, JIS B2220 16K
FG	PED	EN 1092-1 PN10; EN 1092-1 PN16, EN 1092-1 PN25, ASME B16.5 Class 150
FG	ASME	ASME B16.5 Class 150
FD	ASME	ASME B16.5 Class 150, ASME B16.5 Class 300
FS	pvcALS™	EN 1092-1 PN25, EN 1092-1 PN40, ASME B16.5 Class 300
FS	ASME	ASME B16.5 Class 400, JIS B2220 20K
FS	PED	EN 1092-1 PN25, EN 1092-1 PN40, ASME B16.5 Class 300
FS	ASME	ASME B16.5 Class 400
FS	ASME	ASME B16.5 Class 300, ASME B16.5 Class 400

Standard EN 1092-1 corresponds to GOST 12815-80 and GB/T 9115.

### Maximum heat transfer surface

630 m<sup>2</sup> (7000 sq. ft)

## Dimensions

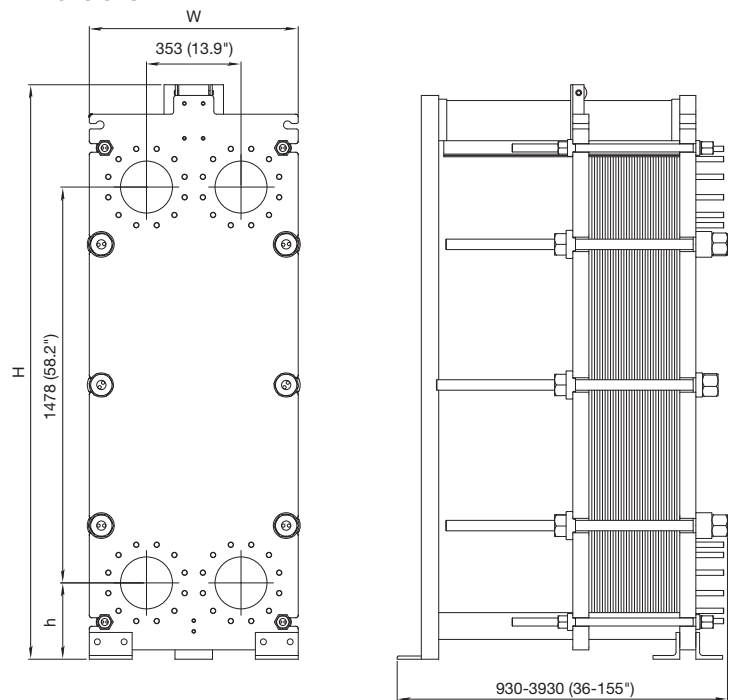

## Measurements mm (inch)

Type	H	W	h
AQ8-FM	2145 (84 1/2")	780 (30 11/16")	285 (11 7/32)
AQ8-FG	2145 (84 1/2")	780 (30 11/16")	285 (11 7/32)
AQ8-FS	2183 (84 1/2")	780 (30 11/16")	323 (12 11/16)

The number of tightening bolts may vary depending on pressure rating.

## Particulars required for quotation

- Flow rates or heat load
- Temperature program
- Physical properties of liquids in question (if not water)
- Desired working pressure
- Maximum permitted pressure drop
- Available steam pressure

The thermal performance is third party certified through the AHRI Liquid to Liquid Heat Exchangers certification program



### How to contact Alfa Laval

Up-to-date AlfaLaval contact details for all countries are always available on our website on [www.alfalaval.com](http://www.alfalaval.com)



# Alfa Laval AQ10

## AlfaQ™ AHRI-certified plate heat exchanger

### Applications

Plate heat exchanger for general heating and cooling duties.

### Standard design

The plate heat exchanger consists of a pack of corrugated metal plates with portholes for the passage of the two fluids between which heat transfer will take place.

The plate pack is assembled between a fix frame plate and a movable pressure plate and compressed by tightening bolts. The plates are fitted with a gasket, which seals the interplate channel and directs the fluids into alternate channels. The number of plates is determined by the flow rate, physical properties of the fluids, pressure drop and temperature program. The plate corrugations promote fluid turbulence and support the plates against differential pressure.

The plate and the pressure plate are suspended from an upper carrying bar and located by a lower guiding bar, both of which are fixed to a support column.

Connections are located in the frame plate or, if either or both fluids make more than a single pass within the unit, in the frame and pressure plates.

### Typical capacities

Liquid flow rate.

Up to 350 kg/s (5600 gpm), depending on media, permitted pressure drop and temperature program.

### Plate types

AQ10, AQ10M plates

### Frame types

FMS, FGS, FG, FD and FS

### Working principle

Channels are formed between the plates and the corner ports are arranged so that the two media flow through alternate channels. The heat is transferred through the plate between the channels, and complete counter-current flow is created for highest possible efficiency. The corrugation of the plates provides the passage between the plates, supports each plate against the adjacent one and enhances the turbulence, resulting in efficient heat transfer.

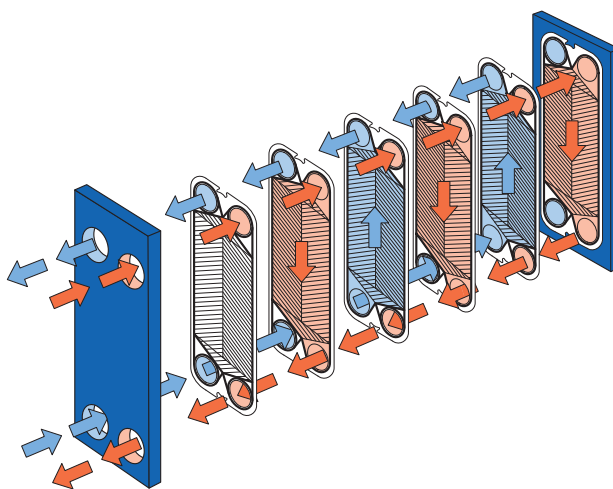
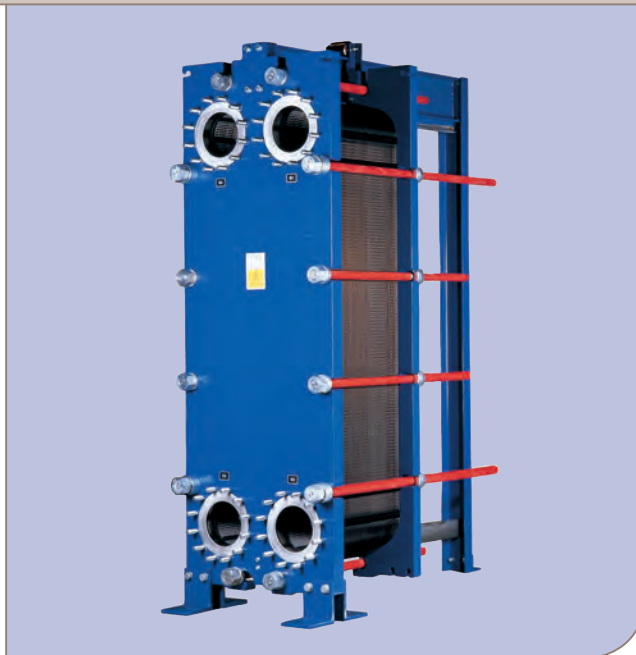

Flow principle of a plate heat exchanger

## STANDARD MATERIALS

### Frame plate

Mild steel, Epoxy painted

### Nozzles

Carbon steel

Metal lined: Stainless steel, Titanium, Alloy C276, Rubber lined: Nitrile, EPDM

### Plates

Stainless steel Alloy 316, Alloy C276, Alloy 254 SMO or Titanium Other grades and material available on request.

### Gaskets

Nitrile, EPDM or Viton

Other grades and material available on request.

## TECHNICAL DATA

### Pressure vessel codes PED, ASME, pvcALS™

#### Mechanical design pressure (g) / temperature

FMS PED, pvcALS™	1.0 MPa / 180°C
FGS PED, pvcALS™	1.6 MPa / 180°C
FGS ASME	150 psig / 350°F
FG PED, pvcALS™	1.6 MPa / 200°C
FG ASME	150 psig / 350°F
FD PED, pvcALS™	2.5 MPa / 210°C
FD ASME	300 psig / 350°F
FS ASME	400 psig / 350°F

### Connections

Size: DN200 / DN250 / NPS 8 / NPS 10 / 200A / 250A

FMS PED	EN 1092-1 PN10, ASME B16.5 Class 150
FMS pvcALS™	EN 1092-1 PN10, ASME B16.5 Class 150, JIS B2220 10K
FGS PED	EN 1092-1 PN16, ASME B16.5 Class 150
FGS pvcALS™	EN 1092-1 PN16, ASME B16.5 Class 150, JIS B2220 10K, JIS B2220 16K
FGS ASME	ASME B16.5 Class 150
FG PED	EN 1092-1 PN16, ASME B16.5 Class 150
FG pvcALS™	EN 1092-1 PN16, ASME B16.5 Class 150, JIS B2220 10K, JIS B2220 16K
FG ASME	ASME B16.5 Class 150
FD PED	EN 1092-1 PN25, ASME B16.5 Class 300
FD pvcALS™	EN 1092-1 PN25, ASME B16.5 Class 300, JIS B2220 20K
FD ASME	ASME B16.5 Class 300
FS ASME	ASME B16.5 Class 400

### Maximum heat transfer surface

940 m<sup>2</sup> (10000 sq. ft)

## Dimensions

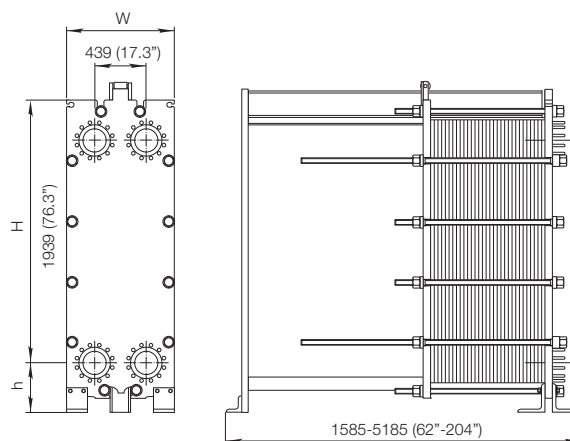

### Measurements mm (inch)

Type	H	W	h
AQ10-FMS	2595 (102")	920 (36.2")	325 (12.8")
AQ10-FGS	2595 (102")	920 (36.2")	325 (12.8")
AQ10-FG	max 3103 (122.2")	920 (36.2")	435 (17.1")
AQ10-FD	max 3103 (122.2")	940 (37")	435 (17.1")
AQ10-FS	max 3103 (122.2")	940 (37")	435 (17.1")

The number of tightening bolts may vary depending on the pressure rating

### Particulars required for quotation

- Flow rates or heat load
- Temperature program
- Physical properties of liquids in question (if not water)
- Desired working pressure
- Maximum permitted pressure drop
- Available steam pressure

The thermal performance is third party certified through the AHRI Liquid to Liquid Heat Exchangers certification program



### How to contact Alfa Laval

Up-to-date AlfaLaval contact details for all countries are always available on our website on [www.alfalaval.com](http://www.alfalaval.com)



# Alfa Laval AQ14S

## AlfaQ™ AHRI-certified plate heat exchanger

### Applications

General heating and cooling duties.

### Standard design

The plate heat exchanger consists of a pack of corrugated metal plates with port holes for the passage of the two fluids between which heat transfer will take place.

The plate pack is assembled between a fixed frame plate and a movable pressure plate and compressed by tightening bolts. The plates are fitted with gaskets, which seal the interplate channels and direct the fluid into alternate channels. The number of plates is determined by the flow rate, physical properties of the fluids, pressure drop and temperature program. The plate corrugations promote fluid turbulence and support the plates against differential pressure.

The frame plate and the pressure plate are suspended from an upper carrying bar and located by a lower guiding bar, both of which are fixed to a support column.

Connections are located in the frame plate or, if either or both fluids make more than a single pass within the unit, in the frame and pressure plate.

### Working principle

Channels are formed between the plates and the corner ports are arranged so that the two fluids flow through alternate channels. The heat is transferred through the plate between the channels, and complete counter-current flow is created for highest possible efficiency. The corrugation of the plates provides the passage between the plates, supports each plate against the adjacent one and enhances the turbulence, resulting in efficient heat transfer.

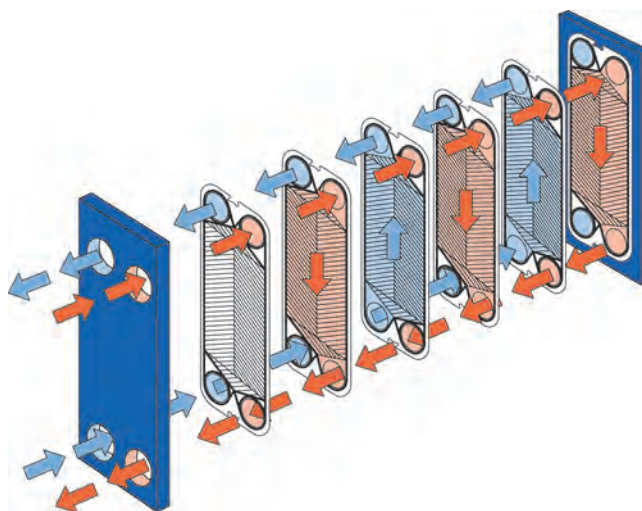
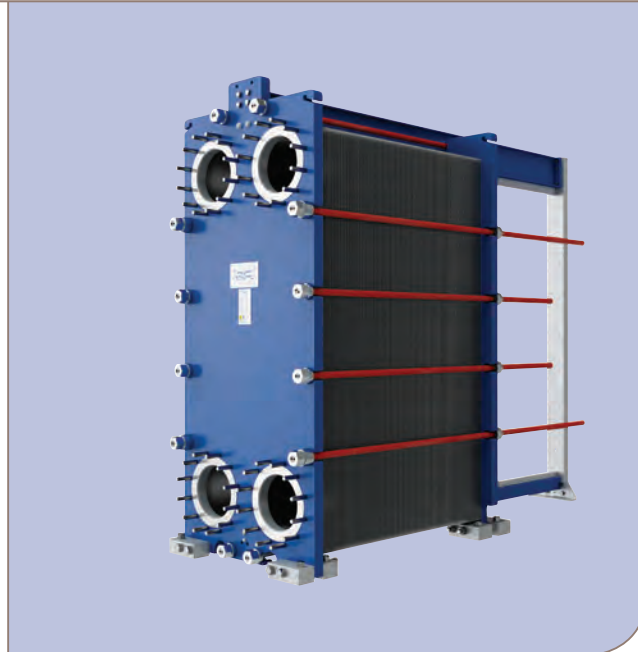

Flow principle of a plate heat exchanger



## STANDARD MATERIAL

### Frame/pressure plate

Mild steel, coated with water-based epoxy paint

Customized paint systems may be available on request.

### Nozzles/Connections

Carbon steel

Metal lined: Stainless steel Alloy 316, Titanium

Other materials may be available on request.

### Plates

Stainless steel Alloy 304, Alloy 316, Titanium

Other materials may be available on request.

### Gaskets

Nitrile, EPDM or Viton

Other grades and materials may be available on request.

## TECHNICAL DATA

### Design pressure (g)

FM	pvcALS™	1.034 MPa
FM	PED	1.034 MPa
FG	pvcALS™	1.6 MPa
FG	PED	1.6 MPa
FG	ASME	150 psig
FD	pvcALS™	2.5 MPa
FD	PED	2.5 MPa
FD	ASME	300 psig
FS	ASME	400 psig

Higher pressures may be available on request.

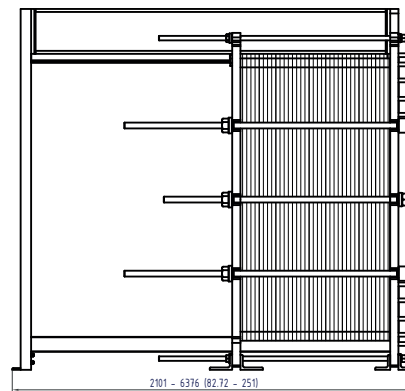
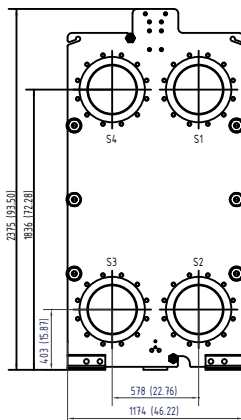

The number of tightening bolts may vary depending on pressure rating.



The thermal performance is third party certified through the AHRI Liquid to Liquid Heat Exchangers certification program

PCT00216EN 1506

Alfa Laval reserves the right to change specifications without prior notification.

### How to contact Alfa Laval

Up-to-date AlfaLaval contact details for all countries are always available on our website on [www.alfalaval.com](http://www.alfalaval.com)

## Design temperature

Determined by gasket material.

## Plate types

AQ14SP

## Connection size

DN350 / NPS 14 / 350A

DN300 / NPS 12 / 300A

## Connection standard

FM	pvcALS™	EN 1092-1 PN10, ASME B16.5 Class 150, JIS B2220 10K
FM	PED	EN 1092-1 PN10, ASME B16.5 Class 150
FG	pvcALS™	EN 1092-1 PN16, ASME B16.5 Class 150, JIS B2220 16K
FG	PED	EN 1092-1 PN16, ASME B16.5 Class 150
FG	ASME	ASME B16.5 Class 150
FD	pvcALS™	EN 1092-1 PN25, ASME B16.5 Class 300, JIS B2220 20K
FD	PED	EN 1092-1 PN25, ASME B16.5 Class 300
FD	ASME	ASME B16.5 Class 300
FS	ASME	ASME B16.5 Class 400

Standard EN 1092-1 corresponds to GOST 12815-80 and GB/T 9115.

Extended connections are available for ASME B16.5 Class 150, Class 300, Class 400 size NPS 14.

## Particulars required for quotation

- Flow rates or heat load
- Temperature program
- Physical properties of fluids in question
- Desired working pressure and temperature
- Allowable pressure drops



# Alfa Laval AQ14

## AlfaQ™ AHRI-certified plate heat exchanger

### Applications

General heating and cooling duties.

### Standard design

The plate heat exchanger consists of a pack of corrugated metal plates with port holes for the passage of the two fluids between which heat transfer will take place.

The plate pack is assembled between a fixed frame plate and a movable pressure plate and compressed by tightening bolts. The plates are fitted with gaskets, which seal the interplate channels and direct the fluid into alternate channels. The number of plates is determined by the flow rate, physical properties of the fluids, pressure drop and temperature program. The plate corrugations promote fluid turbulence and support the plates against differential pressure.

The frame plate and the pressure plate are suspended from an upper carrying bar and located by a lower guiding bar, both of which are fixed to a support column.

Connections are located in the frame plate or, if either or both fluids make more than a single pass within the unit, in the frame and pressure plate.

### Working principle

Channels are formed between the plates and the corner ports are arranged so that the two fluids flow through alternate channels. The heat is transferred through the plate between the channels, and complete counter-current flow is created for highest possible efficiency. The corrugation of the plates provides the passage between the plates, supports each plate against the adjacent one and enhances the turbulence, resulting in efficient heat transfer.

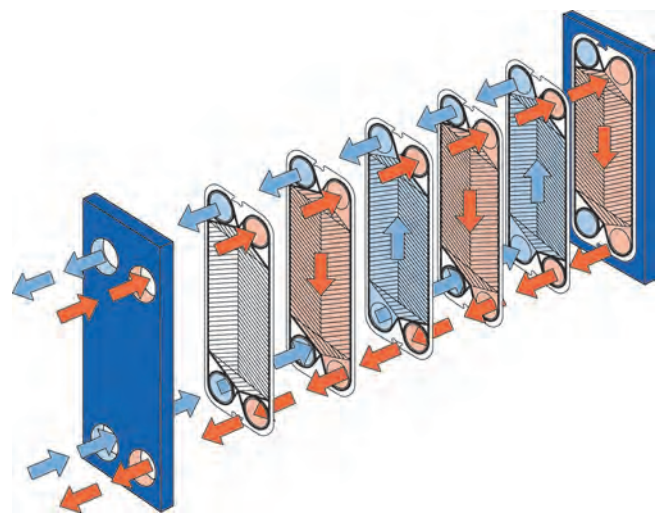
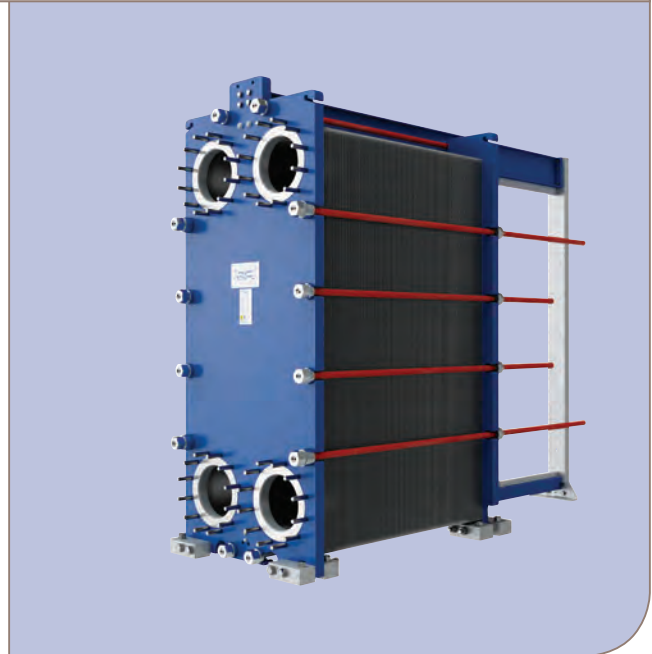

Flow principle of a plate heat exchanger

## STANDARD MATERIAL

### Frame/pressure plate

Mild steel, coated with water-based epoxy paint

Customized paint systems may be available on request.

### Nozzles/Connections

Carbon steel

Metal lined: Stainless steel Alloy 316, Titanium

Other materials may be available on request.

### Plates

Stainless steel Alloy 304, Alloy 316, Titanium

Other materials may be available on request.

### Gaskets

Nitrile, EPDM or Viton

Other grades and materials may be available on request.

## TECHNICAL DATA

### Design pressure (g)

FL	pvcALS™	0.6 MPa
FM	pvcALS™	1.034 MPa
FM	PED	1.034 MPa
FG	pvcALS™	1.6 MPa
FG	PED	1.6 MPa
FG	ASME	150 psig
FD	pvcALS™	2.5 MPa
FD	PED	2.5 MPa
FD	ASME	300 psig
FS	ASME	400 psig

Higher pressures may be available on request.

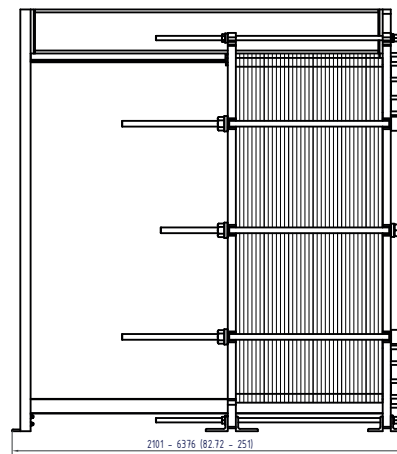
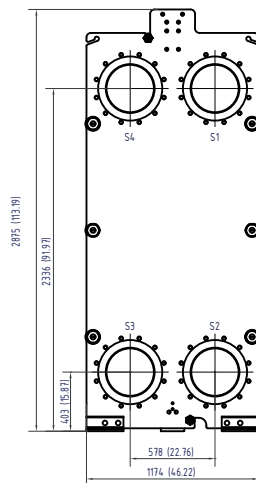

The number of tightening bolts may vary depending on pressure rating.



The thermal performance is third party certified through the AHRI Liquid to Liquid Heat Exchangers certification program

PCT00215EN 1506

Alfa Laval reserves the right to change specifications without prior notification.

### How to contact Alfa Laval

Up-to-date AlfaLaval contact details for all countries are always available on our website on [www.alfalaval.com](http://www.alfalaval.com)

## Design temperature

Determined by gasket material.

## Plate types

AQ14P

## Connection size

DN350 / NPS 14 / 350A

DN300 / NPS 12 / 300A

## Connection standard

FL	pvcALS™	EN 1092-1 PN10, ASME B16.5 Class 150, JIS B2220 10K
FM	pvcALS™	EN 1092-1 PN10, ASME B16.5 Class 150, JIS B2220 10K
FM	PED	EN 1092-1 PN10, ASME B16.5 Class 150
FG	pvcALS™	EN 1092-1 PN16, ASME B16.5 Class 150, JIS B2220 16K
FG	PED	EN 1092-1 PN16, ASME B16.5 Class 150
FG	ASME	ASME B16.5 Class 150
FD	pvcALS™	EN 1092-1 PN25, ASME B16.5 Class 300, JIS B2220 20K
FD	PED	EN 1092-1 PN25, ASME B16.5 Class 300
FD	ASME	ASME B16.5 Class 300
FS	ASME	ASME B16.5 Class 400

Standard EN 1092-1 corresponds to GOST 12815-80 and GB/T 9115.

Extended connections are available for ASME B16.5 Class 150, Class 300, Class 400 size NPS 14.

## Particulars required for quotation

- Flow rates or heat load
- Temperature program
- Physical properties of fluids in question
- Desired working pressure and temperature
- Allowable pressure drops



# Alfa Laval AQ14L

## AlfaQ™ AHRI-certified plate heat exchanger

### Applications

General heating and cooling duties.

### Standard design

The plate heat exchanger consists of a pack of corrugated metal plates with portholes for the passage of the two fluids between which heat transfer will take place.

The plate pack is assembled between a fix frame plate and a movable pressure plate and compressed by tightening bolts. The plates are fitted with a gasket, which seals the interplate channel and directs the fluids into alternate channels. The number of plates is determined by the flow rate, physical properties of the fluids, pressure drop and temperature program. The plate corrugations promote fluid turbulence and support the plates against differential pressure.

The frame plate is stationary, while the pressure plate is movable along the upper carrying bar, which also holds the plate pack. The pressure plate and the plate pack are located by the lower guiding bar. The carrying bar is supported by the frame at one end and a support column at the other which are bolted to the foundation.

Connections are located in the frame plate or, if either or both fluids make more than a single pass within the unit, in the frame and pressure plates.

### Typical capacities

#### Liquid flow rate

Up to 650 kg/s (10400 gpm), depending on media, permitted pressure drop and temperature program.

#### Plate types

AQ14L plates

#### Frame types

FM, FG, FD and FS

### Working principle

Channels are formed between the plates and the corner ports are arranged so that the two media flow through alternate channels. The heat is transferred through the plate between the channels, and complete counter-current flow is created for highest possible efficiency. The corrugation of the plates provides the passage between the plates, supports each plate against the adjacent one and enhances the turbulence, resulting in efficient heat transfer.

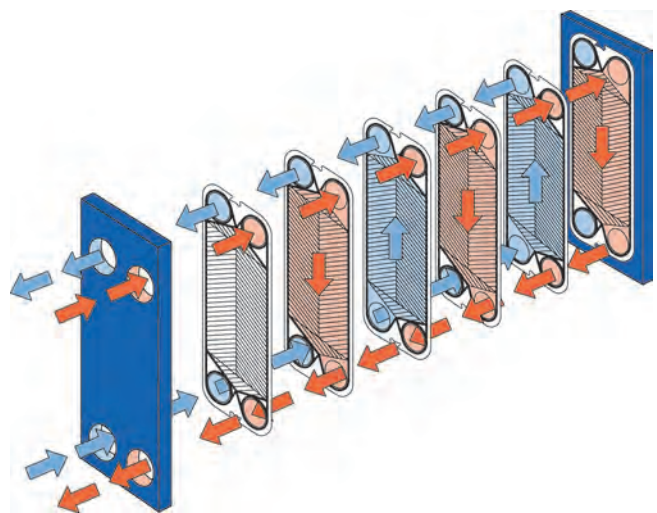
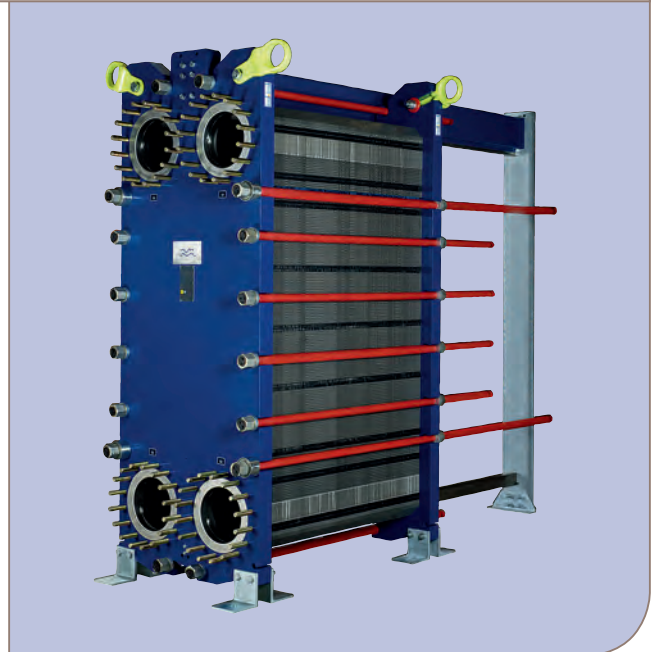

Flow principle of a plate heat exchanger



## STANDARD MATERIALS

### Frame plate

Mild steel, Epoxy painted

### Nozzles

Carbon steel

Metal lined: Stainless steel, Titanium, C276

### Plates

Stainless steel Alloy 316 / Alloy 304 / Alloy 254 / Alloy C276 / Titanium

Other grades and material available on request.

### Gaskets

Nitrile, EPDM or Viton

Other grades and material available on request.

## TECHNICAL DATA

### Pressure vessel codes, PED, ASME, pvcALS™

#### Mechanical design pressure (g) / temperature

FM	PED / pvcALS™	1.0 MPa / 180°C
FM	ASME	100 psig / 350°F
FG	PED / pvcALS™	1.6 MPa / 180°C
FG	ASME	150psig / 350°F
FD	PED	2.5 MPa / 180°C
FD	ALS	2.5 MPa / 160°C
FD	ASME	300 psig / 350°F
FS	PED	3.0 MPa / 180°C
FS	ASME	400 psig / 350°F

## Connections

Size: DN350 / NPS 14 / 350A  
DN300 / NPS 12 / 300A

FM	pvcALS™	EN 1092-1 PN10, ASME B16.5.Class 150, JIS B2220 10K
FM	PED	EN 1092-1 PN10, ASME B16.5.Class 150
FM	ASME	ASME B16.5.Class 150
FG	pvcALS™	EN 1092-1 PN16, ASME B16.5.Class 150, JIS B2220 16K
FG	PED	EN 1092-1 PN16, ASME B16.5.Class 150
FG	ASME	ASME B16.5.Class 150
FD	PED	EN 1092-1 PN25, ASME B16.5.Class 150, ASME B16.5.Class 300
FD	ALS	EN 1092-1 PN25, ASME B16.5.Class 150, ASME B16.5.Class 300 JIS B2220 20K
FD	ASME	ASME B16.5.Class 150, ASME B16.5.Class 300
FS	PED	EN 1092-1 PN25, EN 1092-1 PN40, ASME B16.5.Class 300 ASME B16.5.Class 400
FS	ASME	ASME B16.5.Class 300, ASME B16.5.Class 400

Standard EN 1092-1 corresponds to GOST 12815-80 and GB/T 9115.

## Dimensions

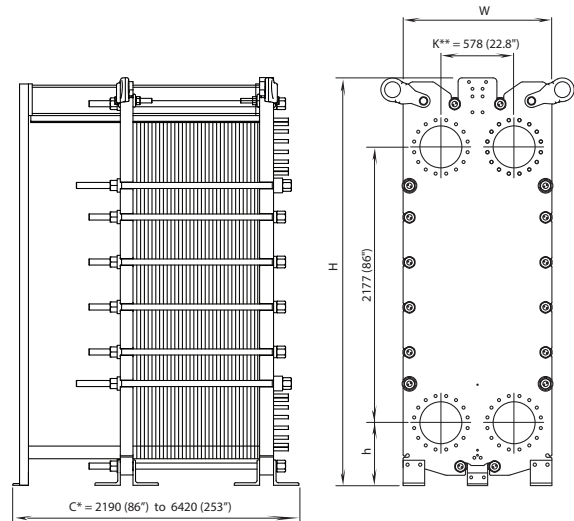

## Measurements mm (inch)

Type	H	W	h
AQ14L-FM	3210 (126.4")	1154 (45.4")	488 (19.2")
AQ14L-FG	3210 (126.4")	1154 (45.4")	488 (19.2")
AQ14L-FD	3218 (126.7")	1174 (46.2")	496 (19.5")
AQ14L-FS	3218 (126.7")	1174 (46.2")	496 (19.5")

The number of tightening bolts may vary depending on pressure rating.

C\* = Larger design available on request.

K\*\* = 578 mm (22.8 inches) except following cases

584 (23.0") FS PED	Size 350 DN PN40
589 (23.2") FD PED/pvcALS™ ASME	Size 14" ASME Cl.300
589 (23.2") FS PED/ASME	Size 14" ASME Cl 300 or 400

## Particulars required for quotation

- Flow rates or heat load
- Temperature program
- Physical properties of liquids in question (if not water)
- Desired working pressure
- Maximum permitted pressure drop
- Available steam pressure

The thermal performance is third party certified through the AHRI Liquid to Liquid Heat Exchangers certification program



ECF00375EN 1506

Alfa Laval reserves the right to change specifications without prior notification.

## How to contact Alfa Laval

Up-to-date AlfaLaval contact details for all countries are always available on our website on [www.alfalaval.com](http://www.alfalaval.com)



# Alfa Laval AQ18

## AlfaQ™ AHRI-certified plate heat exchanger

### Applications

General heating and cooling duties.

### Standard design

The plate heat exchanger consists of a pack of corrugated metal plates with port holes for the passage of the two fluids between which heat transfer will take place.

The plate pack is assembled between a fixed frame plate and a movable pressure plate and compressed by tightening bolts. The plates are fitted with gaskets, which seal the interplate channels and direct the fluid into alternate channels. The number of plates is determined by the flow rate, physical properties of the fluids, pressure drop and temperature program. The plate corrugations promote fluid turbulence and support the plates against differential pressure.

The frame plate and the pressure plate are suspended from an upper carrying bar and located by a lower guiding bar, both of which are fixed to a support column.

Connections are located in the frame plate or, if either or both fluids make more than a single pass within the unit, in the frame and pressure plate.

### Working principle

Channels are formed between the plates and the corner ports are arranged so that the two fluids flow through alternate channels. The heat is transferred through the plate between the channels, and complete counter-current flow is created for highest possible efficiency. The corrugation of the plates provides the passage between the plates, supports each plate against the adjacent one and enhances the turbulence, resulting in efficient heat transfer.

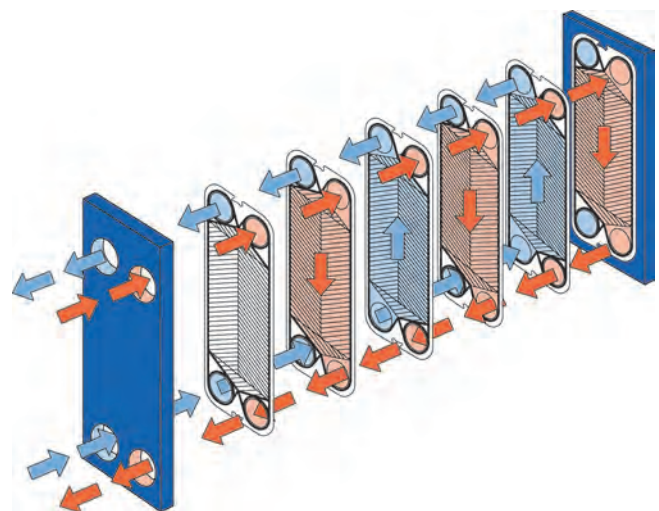
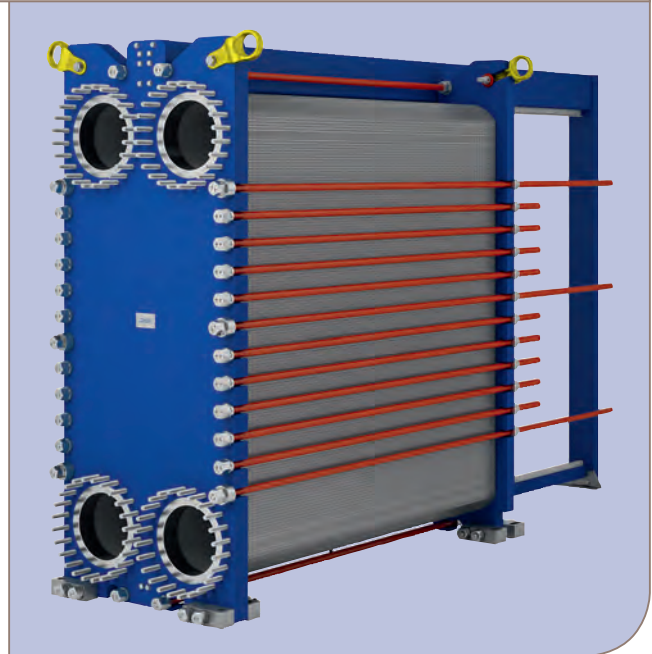

Flow principle of a plate heat exchanger

## STANDARD MATERIAL

### Frame/pressure plate

Mild steel, coated with water-based epoxy paint

### Nozzles/Connections

Carbon steel

Metal lined: Stainless steel Alloy 316, Alloy 254, Titanium

### Plates

Stainless steel Alloy 316, Alloy 254, Titanium

Other materials may be available on request.

### Gaskets

Nitrile, EPDM or Viton

Other materials may be available on request.

## TECHNICAL DATA

### Design pressure (g)

FM	pvcALS™	1.0 MPa
FG	PED	1.6 MPa
FG	pvcALS™	1.6 MPa
FG	ASME	150 psig
FD	ASME	250 psig

Higher pressures may be available on request.

### Design temperature

Determined by gasket material.

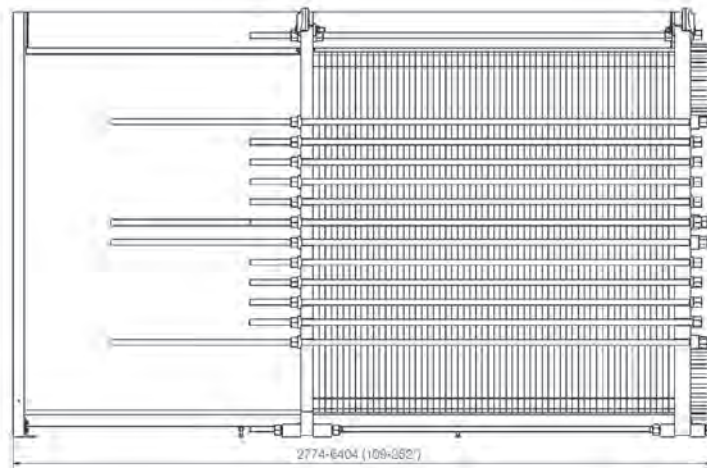
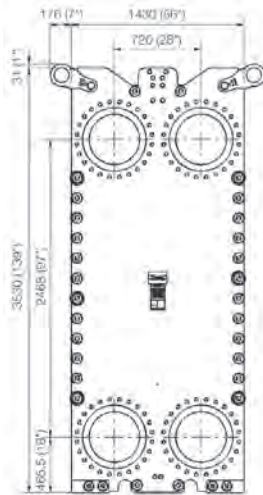

### Maximum liquid flow rate

Up to 1000 kg/s (16000 gpm)

### Maximum standard heat transfer surface

2360 m<sup>2</sup> (25400 sq. ft)

Larger non-standard design available on request.

### Plate types

AQ18

### Connection size

DN450 / NPS 18 / 450A

### Connections

FM	pvcALS™	EN 1092-1 PN10, ASME B16.5 Class 150, JIS B2220 10K
FG	PED	EN 1092-1 PN16, ASME B16.5 Class 150
FG	pvcALS™	EN 1092-1 PN16, ASME B16.5 Class 150, JIS B2220 16K
FG	ASME	ASME B16.5 Class 150
FD	ASME	ASME B16.5 Class 300

Standard EN 1092-1 corresponds to GOST 12815-80 and GB/T 9115.

### Particulars required for quotation

- Flow rates or heat load
- Temperature program
- Physical properties of fluids in question
- Desired working pressure and temperature
- Allowable pressure drops

The number of tightening bolts may vary depending on pressure rating.



The thermal performance is third party certified through the AHRI Liquid to Liquid Heat Exchangers certification program

PCT00217EN 1506

Alfa Laval reserves the right to change specifications without prior notification.

### How to contact Alfa Laval

Up-to-date AlfaLaval contact details for all countries are always available on our website on [www.alfalaval.com](http://www.alfalaval.com)



# Alfa Laval AQ20S

## AlfaQ™ AHRI-certified plate heat exchanger

### Applications

General heating and cooling duties

### Standard design

The plate heat exchanger consists of a pack of corrugated metal plates with portholes for the passage of the two fluids between which heat transfer will take place.

The plate pack is assembled between a fix frame plate and a movable pressure plate and compressed by tightening bolts. The plates are fitted with a gasket, which seals the interplate channel and directs the fluids into alternate channels. The number of plates is determined by the flow rate, physical properties of the fluids, pressure drop and temperature program. The plate corrugations promote fluid turbulence and support the plates against differential pressure.

The frame plate and the pressure plate are suspended from an upper carrying bar and located by a lower guiding bar, both of which are fixed to a support column.

Connections are located in the frame plate or, if either or both fluids make more than a single pass within the unit, in the frame and pressure plates.

### Typical capacities

#### Liquid flow rate

Up to 1300kg/s (20800 gpm), depending on media, permitted pressure drop and temperature program.

#### Plate types

AQ20SM

#### Frame types

FM, FG and FD

### Working principle

Channels are formed between the plates and the corner ports are arranged so that the two media flow through alternate channels. The heat is transferred through the plate between the channels, and complete counter-current flow is created for highest possible efficiency. The corrugation of the plates provides the passage between the plates, supports each plate against the adjacent one and enhances the turbulence, resulting in efficient heat transfer.

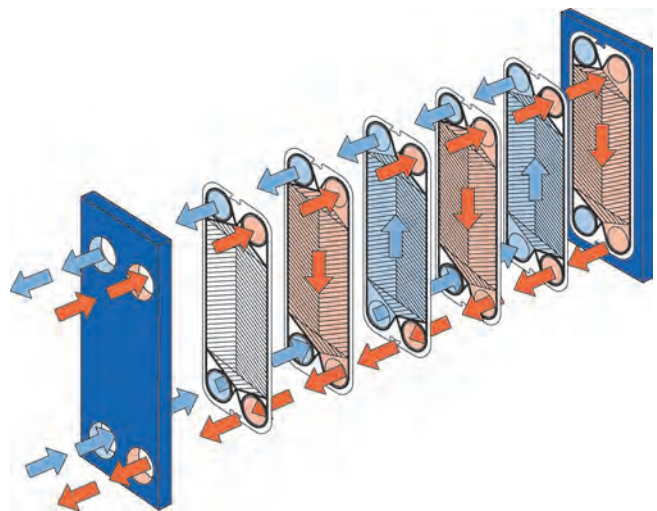
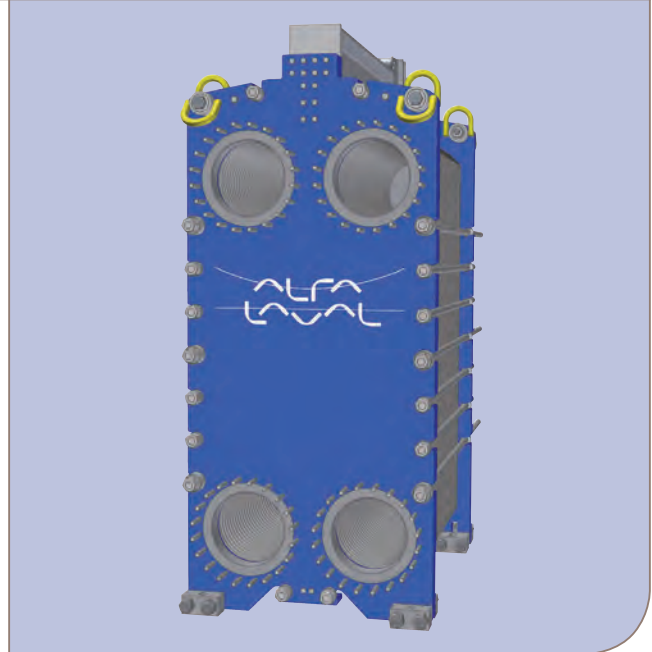

Flow principle of a plate heat exchanger



## STANDARD MATERIALS

### Frame plate

Mild steel, Epoxy painted

### Nozzles

Carbon steel

Metal lined: Stainless steel, Titanium

### Plates

Stainless steel Alloy 316 or Titanium.

### Gaskets

Nitrile or EPDM

## TECHNICAL DATA

### Mechanical design pressure (g) / temperature

FM	pvcALSTM	1.0 MPa / 150°C
FG	PED	1.6 MPa / 180°C
FG	ASME	150 psig / 350°F
FD	PED	2.5 MPa / 180°C
FD	ASME	300 psig / 350°F

## CONNECTIONS

Size: DN500 / NPS 20

FM	pvcALSTM	EN1092-1 PN10 ASME B16.5 Class 150
FG	PED	EN1092-1 PNa, EN1092-1 PN16 ASME B16.5 Class 150
FG	ASME	ASME B16.5 Class 150
FD	PED	EN1092-1 PN25 ASME B16.5 Class 300
FD	ASME	ASME B16.5 Class 150, ASME Cl. 300

Standard EN 1092-1 corresponds to GOST 12815-80 and GB/T 9115.

### Maximum heat transfer surface

2100 m<sup>2</sup> (22700 sq. ft)

## Dimensions

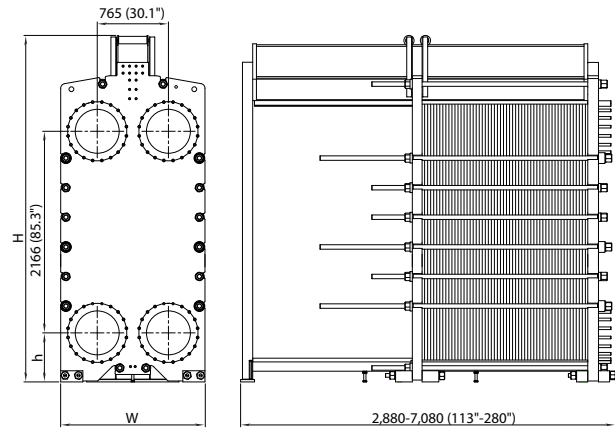

## Measurements mm (inch)

Type	H	W	h
AQ20S-FM	3433(135 4/25")	1550 (61")	467(18 3/8")
AQ20S-FG	3723(146 9/16")	1550 (61")	467(18 3/8")
AQ20S-FD	3723(146 9/16")	1550 (61")	467(18 3/8")

The number of tightening bolts may vary depending on pressure rating.

## Particulars required for quotation

- Flow rates or heat load
- Temperature program
- Physical properties of liquids in question
- Desired working pressure
- Maximum permitted pressure drop
- Available steam pressure

The thermal performance is third party certified through the AHRI Liquid to Liquid Heat Exchangers certification program



### How to contact Alfa Laval

Up-to-date AlfaLaval contact details for all countries are always available on our website on [www.alfalaval.com](http://www.alfalaval.com)



# Alfa Laval AQ20

## AlfaQ™ AHRI-certified plate heat exchanger

### Applications

General heating and cooling duties

### Standard design

The plate heat exchanger consists of a pack of corrugated metal plates with portholes for the passage of the two fluids between which heat transfer will take place.

The plate pack is assembled between a fix frame plate and a movable pressure plate and compressed by tightening bolts. The plates are fitted with a gasket, which seals the interplate channel and directs the fluids into alternate channels. The number of plates is determined by the flow rate, physical properties of the fluids, pressure drop and temperature program. The plate corrugations promote fluid turbulence and support the plates against differential pressure.

The frame plate and the pressure plate are suspended from an upper carrying bar and located by a lower guiding bar, both of which are fixed to a support column.

Connections are located in the frame plate or, if either or both fluids make more than a single pass within the unit, in the frame and pressure plates.

### Typical capacities

#### Liquid flow rate

Up to 975 kg/s (15500 gpm), depending on media, permitted pressure drop and temperature program.

#### Plate types

AQ20M

#### Frame types

FM, FG and FD

### Working principle

Channels are formed between the plates and the corner ports are arranged so that the two media flow through alternate channels. The heat is transferred through the plate between the channels, and complete counter-current flow is created for highest possible efficiency. The corrugation of the plates provides the passage between the plates, supports each plate against the adjacent one and enhances the turbulence, resulting in efficient heat transfer.

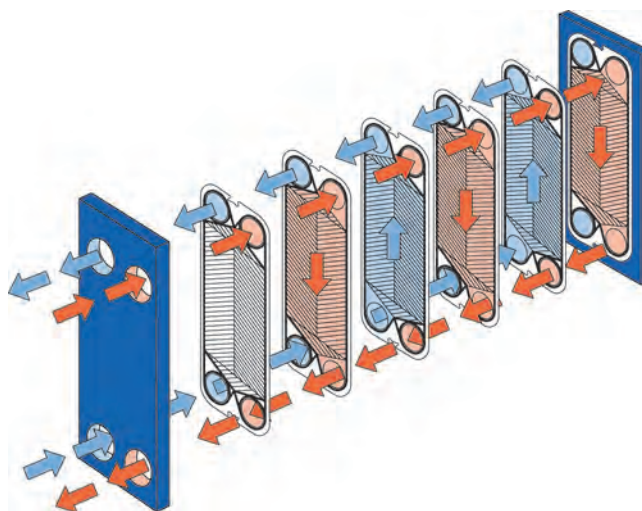
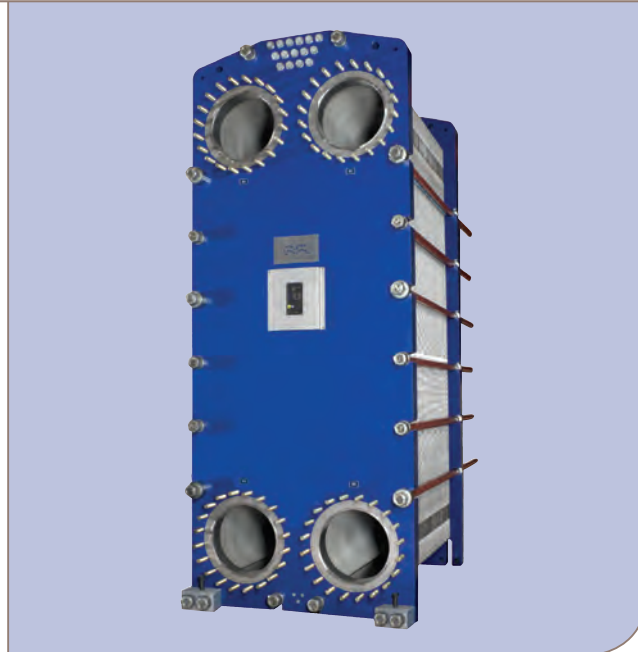

Flow principle of a plate heat exchanger

## STANDARD MATERIALS

### Frame plate

Mild steel, Epoxy painted

### Nozzles

Carbon steel

Metal lined: Stainless steel, Titanium

### Plates

Stainless steel Alloy 316, Alloy 254 or Titanium.

### Gaskets

Nitrile or EPDM

## TECHNICAL DATA

### Mechanical design pressure (g) / temperature

FM	pvcALSTM	1.0 MPa / 150°C
FG	PED	1.6 MPa / 180°C
FG	ASME	150 psig / 350°F
FD	PED	2.5 MPa / 180°C
FD	ASME	300 psig / 350°F

## CONNECTION STANDARD

Size: DN500 / NPS 20

FM	pvcALSTM	EN 1092-1 PN10 ASME B16.5 Class. 150
FG	PED	EN 1092-1 PN10, EN 1092-1 PN16 ASME B16.5 Class 150
FG	ASME	ASME B16.5 Class 150
FD	PED	EN 1092-1 PN25 ASME B16.5 Class 300
FD	ASME	ASME B16.5 Class 150, ASME B16.5 Class 300

Standard EN 1092-1 corresponds to GOST 12815-80 and GB/T 9115.

### Maximum heat transfer surface

2880 m<sup>2</sup> (31018 sq. ft)

## Dimensions

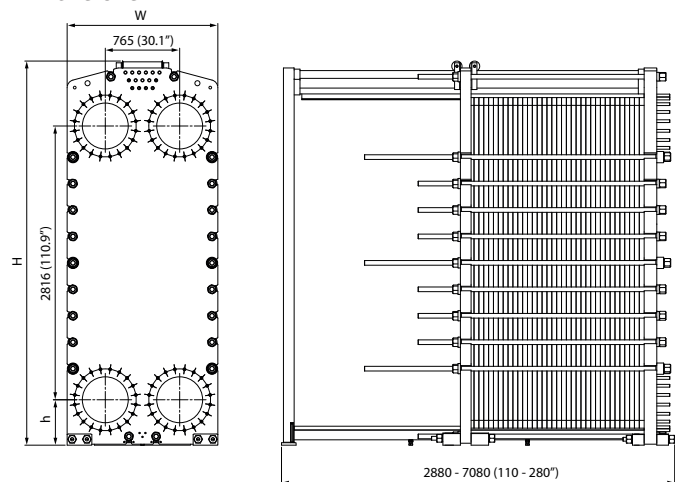

## Measurements mm (inch)

Type	H	W	h
AQ20-FM	4095(161 <sup>7</sup> / <sub>8</sub> "	1550 (61")	467(18 <sup>3</sup> / <sub>8</sub> "
AQ20-FG	3951(155 <sup>9</sup> / <sub>16</sub> "	1550 (61")	467(18 <sup>3</sup> / <sub>8</sub> "
AQ20-FD	3951(155 <sup>9</sup> / <sub>16</sub> "	1550 (61")	467(18 <sup>3</sup> / <sub>8</sub> "

The number of tightening bolts may vary depending on pressure rating.

## Particulars required for quotation

- Flow rates or heat load
- Temperature program
- Physical properties of liquids in question
- Desired working pressure
- Maximum permitted pressure drop
- Available steam pressure

The thermal performance is third party certified through the AHRI Liquid to Liquid Heat Exchangers certification program



### How to contact Alfa Laval

Up-to-date AlfaLaval contact details for all countries are always available on our website on [www.alfalaval.com](http://www.alfalaval.com)



# Plate heat exchanger

## Heating insulation

### Standard design

The Alfa Laval heating insulation is designed to insulate the heat exchanger at operating temperatures up to 180°C. It is delivered in sections (panels) in a separate box along with the heat exchanger. The system of panels ensures simple assembly and disassembly. Most insulation types are equipped with connecting spring locks in galvanized steel.

### Benefits

The insulation saves energy and provides protection against the heat of the plate pack. It also assures a dry and comfortable working climate in the operating room. The graph below shows the effect (W) lost to the environment for un-insulated plate heat exchangers as function of the difference ( $\Delta t$ ) between the temperature inside the plate heat exchanger and the ambient temperature.

### Availability

Heating insulations are available for most of the Alfa Laval plate heat exchangers. The table on the next page shows measurements for standard types.



- A** = M3 60 plts
- B** = M6 100 plts
- C** = M10 200 plts
- D** = M15 150 plts
- E** = MX25 300 plts
- W** = Heat released from different sizes of Alfa Laval plate heat exchangers.
- $\Delta t$**  = The difference between the average temperature inside the plate heat exchanger and the environment.

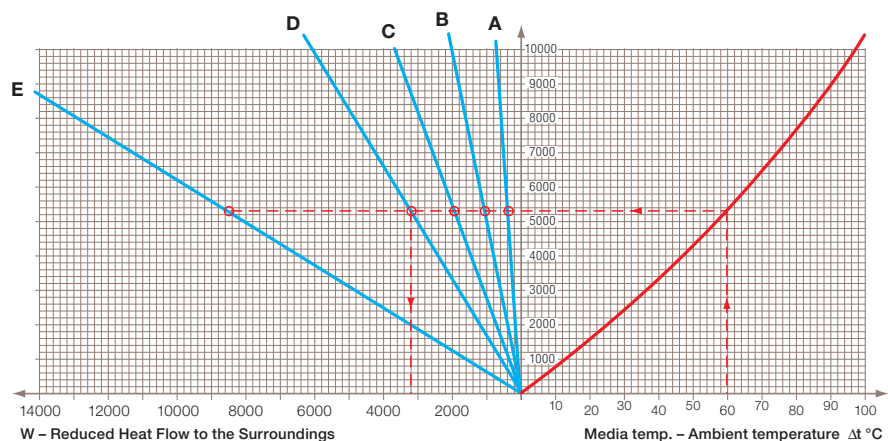

### Example: M15-BFG 150 plates

1\*M15-B Alloy 316 0.50 mm  
 Load = 12927 LMTD = 19,9 k = 7045  
 Water T = 110,0->70,0 1\*75 L S1->S2  
 Water T = 90,2<-50,0 1\*75 L S4<-S3  
 Average temperature inside the PHE (110 + 70 + 50 + 90) / 4 = 80°C.

Ambient temperature 20°C.  
 $\Delta t = 80 - 20 = 60^\circ\text{C}$   
 The heat released will then be 3200 W or 3.2 kW.  
 This is less than 0,3 promille of the total heat exchanged in the PHE.



## Dimensions

Measurements in mm (inch)\*.

PHE type	L <sub>min-max</sub>	W <sub>max</sub>	H <sub>max</sub>
T2	240-350 (9.45-13.78)	220 (8.66)	380 (14.96)
M3	380-640 (14.96-25.20)	260 (10.24)	520 (20.47)
TL3	440-890 (17.32-35.04)	270 (10.63)	830 (32.68)
T5	300-480 (11.81-18.90)	380 (14.96)	800 (31.50)
TS6	360-825 (14.17-32.48)	545 (21.46)	760 (29.92)
M6	300-850 (11.81-33.46)	450 (17.72)	1005 (39.57)
TL6	300-850 (11.81-33.46)	450 (17.72)	1315 (51.78)
M10	450-1160 (17.72-45.67)	600 (23.62)	1095 (43.11)
TL10	450-1960 (17.72-77.16)	640 (25.20)	2100 (82.67)
M15	450-1960 (17.72-77.16)	820 (32.28)	2250 (88.58)
TL15	500-2900 (19.68-114.17)	820 (32.28)	2880 (113.39)
TS20	500-1850 (19.68-72.83)	930 (36.61)	1600 (62.99)
T20	530-2560 (20.87-100.79)	920 (36.22)	2400 (94.49)
MX25	550-2580 (21.65-101.57)	1070 (45.13)	3200 (125.98)
TL35	950-4120 (37.40-162.20)	1320 (51.97)	3300 (129.92)

\*) For exact dimensions frame type including A-measurement must be specified.

## Technical specification

Item	All PHE types excl. type	PHE type
	T2, M3, TL3, T5	T2, M3, TL3, T5
	Alustucco	Alustucco
Plating	1 mm (0.039 in)	1 mm (0.039 in)
Insulation material	Mineral wool 65 mm (2.56 in)	Mineral wool 40 mm (1.57 in)
Inside layer	Aluminum folie 0.05 mm (0.002 in)	Aluminum folie 0.05 mm (0.002 in)
Panel fixation	Snap locks galvanized	Screws

## Particulars required for quotation

- Frame type
- A-measurement
- Tightening bolt length
- Type of connections
- Connection positions

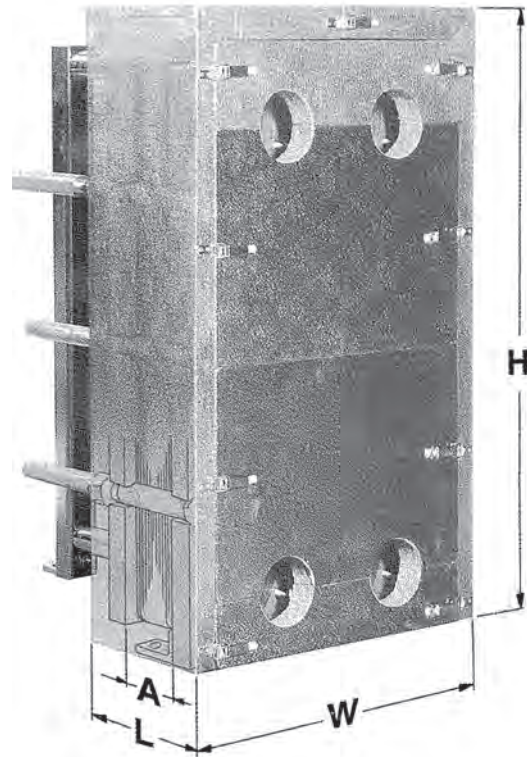

## How to contact Alfa Laval

Up-to-date AlfaLaval contact details for all countries are always available on our website on [www.alfalaval.com](http://www.alfalaval.com)



# Bolt protection sleeves

## Genuine spare parts

Extending the working life of a heat exchanger means taking care of every single part, and making sure that they serve their function efficiently.

Plastic sleeves that slide over the tightening bolts keep the threads free from dirt and other deposits, and make it easier to open and close the heat exchanger for maintenance and cleaning, all of which ensures less downtime.

The bright red colour makes the sleeves easily visible, aids checks and helps prevent accidents. When ordering, please specify the bolt dimensions and total length.

Bolt sleeves are available by specified length in meters.

### Benefits

Using Alfa Laval genuine spare parts means you can be sure that the plastic bolt protection sleeves fit perfectly, and work exactly as intended.

### Ordering information

Part number	Size	Measurements
1995-101-097	M20	18 x 20 mm
1995-101-096	M24	24 x 22 mm
1995-101-086	M24	26 x 28 mm
1995-101-082	M30	32 x 34 mm
1995-101-079	M39	41 x 43 mm
1995-101-081	M48	51 x 53 mm

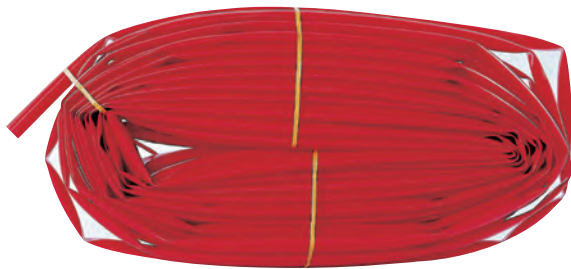

**How to contact Alfa Laval**

Up-to-date AlfaLaval contact details for all countries are always available on our website on [www.alfalaval.com](http://www.alfalaval.com)



## Pneumatic tightening device – PHETD80

### Maintenance tools

The Alfa Laval PHETD80 is an automatic two-speed pneumatic tightening device designed to make it easy to open and close plate heat exchangers. Available in both single and twin models, this device spins the nut down at high speed, while the final tightening is automatically geared down to low speed.

The PHETD80 is easy to handle and work with, and ensures excellent operator safety. It works from both the nut side and the head side of the bolt. The handle of the drive unit can be rotated freely, in order to ensure that the user can use it while in the operating position that is most comfortable. Another operator safety feature is the low level of vibration.

The air connectors are of the ErgoQIC type, which limits energy loss and makes it easy to disconnect the hose, with no air blow out.

The PHETD80 is delivered complete with an air handling unit that includes a water separator, mist lubricator and air flow regulator, with a 5-metre length of air hose connecting the air handling unit and tightening device. All the components are packed in a sturdy wooden case for transporting and storing the device safely.

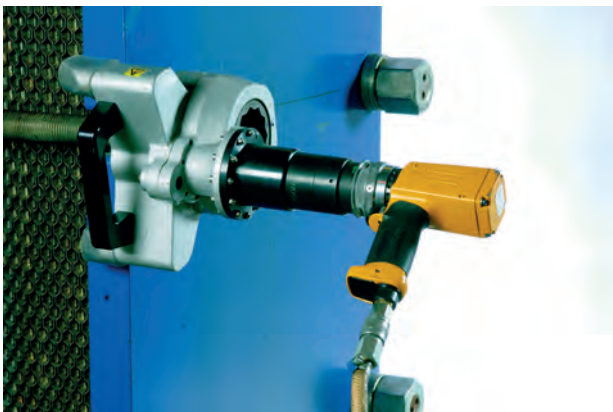

#### Features

- Purpose-built for plate heat exchangers
- Modular design with variable socket keys
- Continuous twin motor operation with automatic changeover
- Sturdy design
- Easy to operate, and low level of vibration
- Optional extras: socket keys in different sizes (NW36, 46, 50, 55, 60, 65 and 75)

#### Benefits

- Can be used on bolt head or nut at either end of plate heat exchanger
- One single tool for all bolt sizes
- No hammering effect avoids damaging equipment and bolts
- Reliable operation
- Reduced downtime



## Technical specifications

Socket key size	NW80 (with inserts for smaller sizes)
Maximum torque	3,270 Nm (2390 ftlb)
Maximum air pressure	6.3 barg (91.4 psig)
Minimum air pressure	3.0 barg (43.5 psig)
Air consumption at free speed	19 l/s (40 cfm)
Oil volume mist lubricator	0.2 l (12 in <sup>3</sup> )
Weight	17 kg (37 lbs)
L x W	54 x 25 cm (21 x 10 in)
Measured sound pressure level	79 dB(A)
Measured vibration value	<2.5 m/s <sup>2</sup>
Air hose length	5 m (16 ft)

## Ordering information

Art. no.	Component
32840-421-01	Tightening device PHETD80, complete*
32840-433-01	Tightening device PHETD80, double, complete

## Socket keys

32840-004-01	Socket key reducer 80/75
32840-004-02	Socket key reducer 80/60
32840-004-03	Socket key reducer 80/46
32840-004-04	Socket key reducer 80/36
32840-004-05	Socket key reducer 80/65
32840-004-06	Socket key reducer 80/55

\* Complete unit includes: Atlas Copco pneumatic wrench unit, fitted with special Alfa Laval gearbox air handling unit with regulator, filter and mist lubricator, 5-metre air hose with ErgoQIC connectors, socket key NW80, 1 litre lubricating oil, packing and storage box, fitted with carrying handles.



The handle of the drive unit can be rotated freely to ensure the most comfortable operating position.

### How to contact Alfa Laval

Up-to-date AlfaLaval contact details for all countries are always available on our website on [www.alfalaval.com](http://www.alfalaval.com)



## Electric tightening device – PHE-ETD80

### Maintenance tools



The Plate Heat Exchanger Electric Tightening Device unit, type PHE-ETD80 is an all-current appliance designed for easy opening and closing of plate heat exchangers. The high safety factor of IP 54 and the multi voltage and frequency motor ensures a safe and versatile tool that can operate on most mains net work or generators.

Its ease of handle includes the choice of free or fixed joint between the motor drive unit and the gear unit. By this feature the most comfortable handle position can be selected depending on which side of the plate heat exchanger the opening or tightening takes place.

Rotation direction is selected by the double function trigger; there is no need to change the hand grip. This together with a power supply switch ensures a high operator safety. The tightening device is equipped with an automatic safety monitoring function to protect the motor against damages in case of a possible overload.

#### Features

- Purpose-built for plate heat exchangers
- Modular design with variable socket keys
- Free joint or fixed connection between drive and gear box
- Double function trigger for clock wise or counter clock wise rotation
- Automatic temperature controlled overload protection
- Continual rotational speed
- Optional extras: Socket inserts in various sizes

#### Benefits

- Can be used on bolt head or nut at either end of plate heat exchanger
- One tool for all sizes of tightening bolts
- Easy and comfortable operation
- No hammering effect avoids damaging equipment and bolts
- Comfortable operation
- Reduced downtime

## Technical specification

Socket key size	NW80 mm (inserts for smaller sizes)
Maximum torque	3300 Nm (2430 lbft)
Current	10 Amps
Electrical connection	100-250 V; 45-66 Hz
Protection	IP 54
Idle speed	6 rpm
Weight	21 kg (46 lb)
LxW	62x32 cm (25x13 in)
Sound pressure level	max. 86 dB(A)



## Ordering data

Art no	Component
32840435-01	Electric Tightening Device PHE-ETD80
32840004-01	Socket key reducer NW 80/75
32840004-02	Socket key reducer NW 80/60
32840004-03	Socket key reducer NW 80/46
32840004-04	Socket key reducer NW 46/36
32840004-05	Socket key reducer NW 80/65
32840004-06	Socket key reducer NW 80/55

PPS00016EN 0603

Alfa Laval reserves the right to change specifications without prior notification.

### How to contact Alfa Laval

Up-to-date AlfaLaval contact details for all countries are always available on our website on [www.alfalaval.com](http://www.alfalaval.com)



## Pneumatic nutrunner & thread cleaner - PHENR80

### Maintenance tools



Pneumatic tool for improved service efficiency of plate heat exchangers

The Alfa Laval Nutrunner & Thread Cleaner is a compressed air powered service tool designed to transport nuts on long threads and to efficiently clean bolt threads from rust and dirt.

When opening and tightening a PHE that has been in service for some time it is a common problem that the threads on the tightening bolts have been attacked by corrosion or that dirt deposits have been formed. Bolts have to be cleaned from this before the nuts can be loosened, a very time-consuming manual work. With large plate packs fitted, the loosened nuts must be moved long distances, a tiring and time-consuming work.

The Thread Cleaner has knives that effectively clean the bolt threads in a fraction of the time it takes to do the job manually. Keeping threads clean and free from surface rust minimizes wear and tear on the bolts during the tightening operation, thus prolonging bolt lifetimes. The thread cleaner can handle bolt sizes from M30 to M52.

For increased safety and ease of handle, the Nutrunner is equipped with a safety ring to which a balancing block may be connected.

#### Features

- Transport nuts on long threads
- Efficiently cleans bolt threads
- Excellent ergonomics
- Fit bolt sizes M30-M52

#### Benefits

- Increased service efficiency
- Lower service cost
- Lower tool costs
- Longer life time of tightening bolts

The PHENR80 is the ideal complement to the Pneumatic Tightening Device PHETD80.



## Technical specification

Socket key size	NW 80 for M39, M48 and M52 bolt size
Socket key insert sizes	NW 65 for M42 bolt size
	NW 46 for M30 bolt size
Air consumption at free speed	10 l/s free air
Max air pressure	7 bar
Connection compressed air	¼" female
Nut runner speed	Max 210 rpm
Thread cleaning capacity cutting edge A	M38-M52
Thread cleaning capacity cutting edge B	M30-M38
Mechanical connection drive unit	½" square
Weight complete with drive unit	3.7 kg
Material housing	Alumina and stainless steel
Material cutting edges	Steel
Air motor	Steel

## Ordering information

Art. No.	Component
32840468-01	Kit Nut Runner, Thread Cleaner & Drive Unit
32840468-02	Kit Nut Runner & Drive Unit
32840468-08	Spare kit washers and o-rings for thread cleaner
32840468-09	Spare kit cutting edges for thread cleaner
32840468-12	Socket key 80/46
32840468-14	Socket key 80/65

PPS00106EN 1202

Alfa Laval reserves the right to change specifications without prior notification.

### How to contact Alfa Laval

Up-to-date AlfaLaval contact details for all countries are always available on our website on [www.alfalaval.com](http://www.alfalaval.com)



# Chapter 7

1. The Alfa Laval Group
2. Heating and cooling solutions from Alfa Laval
3. Applications
4. The theory behind heat transfer
5. Product range
6. Gasketed plate heat exchangers
- 7. Brazed plate heat exchangers**
8. Fusion-bonded plate heat exchangers, AlfaNova
9. Air heat exchangers
10. All-welded heat exchangers
11. Filters





# Brazed plate heat exchangers (BHE)

Alfa Laval's first plate heat exchanger was introduced to the dairy industry in 1931. As a development from the traditional gasketed plate heat exchanger, Alfa Laval introduced the world's first brazed plate heat exchanger in 1977. Since then, continuous developments have been made to optimize its performance and reliability.

Brazed plate heat exchangers offer multiple benefits. The brazing technology eliminates the need for seals and thick frame plates and the design offers excellent resistance to pressure and thermal fatigue in a wide range of heating and cooling applications.

Brazed plate heat exchangers from Alfa Laval are frequently a natural first alternative all over the world.





Alfa Laval invented the world's first BHE in 1977 and since then, continuous developments have been made to optimise its performance and reliability.

## Five reasons to buy your BHEs from the market leader

### 1. Designed to withstand exhausting conditions

As the world-leading BHE manufacturer, Alfa Laval has long experience in designing BHEs that will withstand exhausting pressure and temperature fatigue conditions. Years of R&D, unique patented solutions and innovative product design, coupled with an extensive testing program, ensure that the durability and lifetime of an Alfa Laval BHE will be hard to match.

### 2. A wide range of solutions

Alfa Laval BHEs come in a wide range of sizes and capacities. Different plate patterns and connections are available for various duties and performance specifications, and the BHE can be designed as a one-pass, two-pass or multipass unit. We have the ideal solution for every specific need. You can choose a standard configuration BHE, or a unit designed according to your own specific needs. The choice is entirely yours.

### 3. Full compliance with PED

All Alfa Laval BHEs comply with the European Pressure Vessel Safety Directive, PED, in terms of mechanical and materials specifications. They can also be delivered according to other relevant standards. Various national codes are also available.

### 4. Fast deliveries and service worldwide

Alfa Laval is truly a global company. Our regional distribution centres serve Alfa Laval facilities and distributors worldwide, ensuring fast delivery to customers. Wherever you are, talk to us, we're only a phone call away.

### 5. A partner you can trust

Genuine application know-how and long experience make Alfa Laval the ideal business partner for heating and cooling. Rely on us to supply the most cost-effective solution for your specific needs – we won't let you down.

Choosing Alfa Laval makes sound financial sense!







## A few benefits of using brazed plate heat exchangers

### **Low capital investments**

Thanks to the high heat-transfer coefficients, the required plate surface area can be quite small. Reducing the amount of material used makes for significant savings.

### **Small footprint**

With its compact design, the brazed plate heat exchanger has a smaller footprint than any other comparable solution.

### **Low installation costs**

Parallel and counter-current flow connections make installation easy, reducing costs for pipes and valves.

### **Minimum downtime**

Thanks to a perfect plate corrugation design, high turbulence inside the heat exchanger optimizes the self-cleaning effect and thus reduces scaling. As there are no gaskets, the risk of leakage is virtually non-existent.

### **Maximum reliability**

The brazed plate heat exchangers are individually leak- and pressure-tested to ensure first-class quality and Alfa Laval has approvals from all major certification bodies.



Save energy!  
Save time!  
Save money!

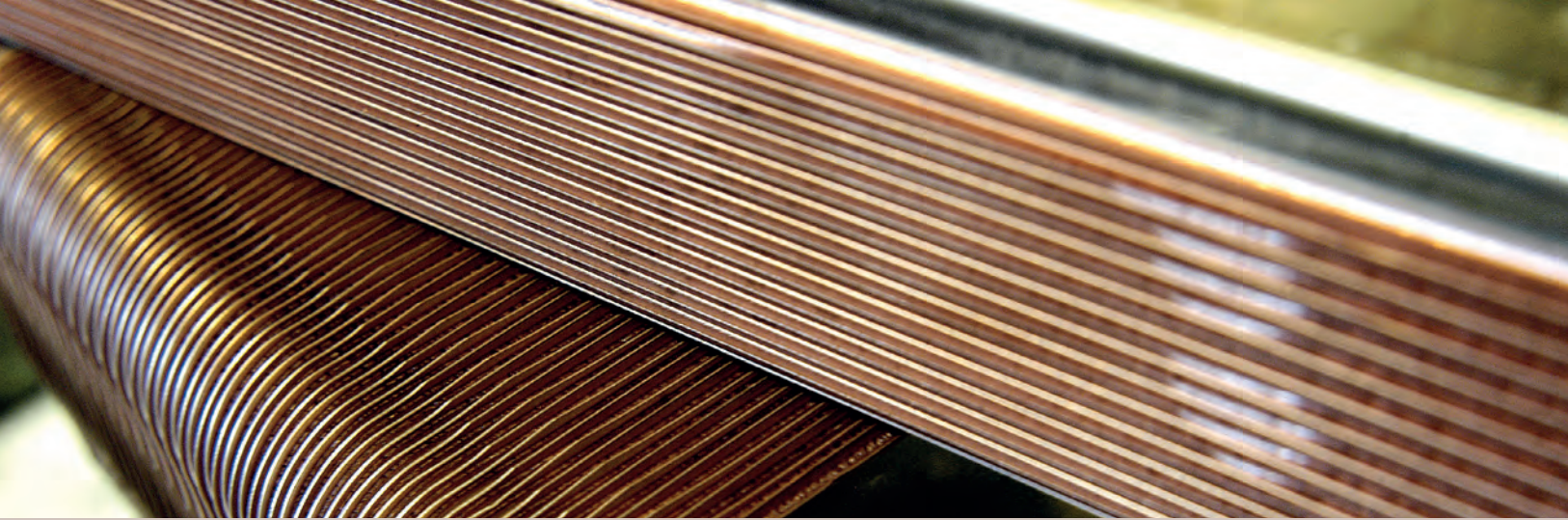

- Fouling is minimized by the turbulent flow, resulting in a self-cleaning effect
- All BHEs are leak- and pressure-tested before delivery
- 75 years of heat-transfer technology experience included in each BHE

#### **Design**

The brazed plate heat exchanger consists of thin corrugated stainless steel plates (AISI 316) which are vacuum-brazed together using copper as the brazing material.

Brazing the stainless-steel plates together eliminates the need for sealing gaskets and thick frame plates.

The brazing material seals as well as holds the plates together at the contact points. Alfa Laval's brazed plate heat exchangers are always brazed at all contact points, which ensures optimal heat-transfer efficiency and pressure resistance.

The plates are designed to achieve maximum possible lifetime.

Since virtually all the material is used for heat transfer, the BHE is very compact in size, has low weight and a small hold-up volume.

Compact, reliable  
and cost efficient

#### **Focus on fatigue**

The expected lifetime of the heat exchanger is influenced by many factors, especially temperature and pressure variations in load conditions. In the case of high loads (pressure peaks, fast temperature changes), this can lead to fatigue failures, with a leaking BHE as the consequence.

Alfa Laval has extensive test facilities for pressure and temperature fatigue. The fatigue characteristics of each model are measured and analysed over and over again. With the help of the statistical data from our Fatigue Analysis Program we can estimate the lifetime of a BHE in a certain application.

The plate material in the heat exchanger is designed to match the demands on pressability as well as "brazability" and fatigue durability. Metallurgical and design factors influencing fatigue are areas of constant focus for Alfa Laval's R&D engineers when developing BHEs.

Years of continuing studies of the fatigue phenomena has put Alfa Laval in the forefront when it comes to developing and producing long lasting BHEs.

#### **Production**

Alfa Laval leads the development towards top quality. We do it by advanced production technology in high volumes. We do it with new technology, through constant research and development. We do it in delivery and service. As a leading global manufacturer we do it by offering a complete product range of heat exchangers. Our knowledge gives you the best solutions, products with higher technical performance and a focus on energy savings.

Quality must prevail through the whole chain from development to after sales. The brazed plate heat exchangers are individually leak- and pressure-tested to ensure first-class quality, and Alfa Laval has approvals from all major certification bodies.





- Small footprint and low weight, 10-20% of a traditional shell & tube
- High temperature and pressure durability
- Excellent fatigue resistance

#### Design options

The design options of the brazed heat exchanger are extensive. Different plate patterns are available for various duties and performance specifications. The BHE can be designed as a one-pass, two-pass or multi-pass unit. A wide range of connections are available, and there is also the option of choosing the placement of the connection.

Alfa Laval offers a wide range of standard heat exchanger models and sizes, tailor-made for industrial applications and district heating, that are available from stock. Customer-specific designs can be offered when requested.

#### Flow principle

The basic flow principle in a brazed heat exchanger for industrial applications is parallel and counter-current to achieve the most efficient heat-transfer process. In a standard single-pass design all connections are located on one side of the heat exchanger, making installation very easy.

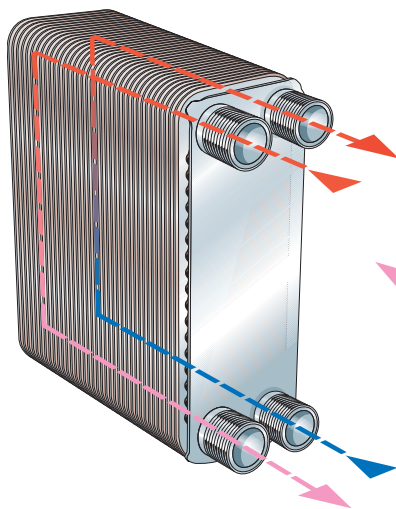

One-pass

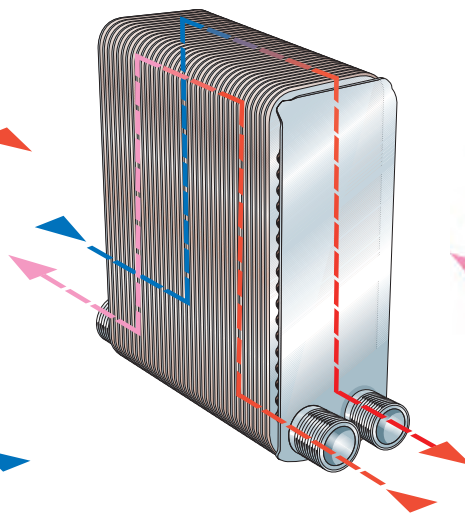

Two-pass

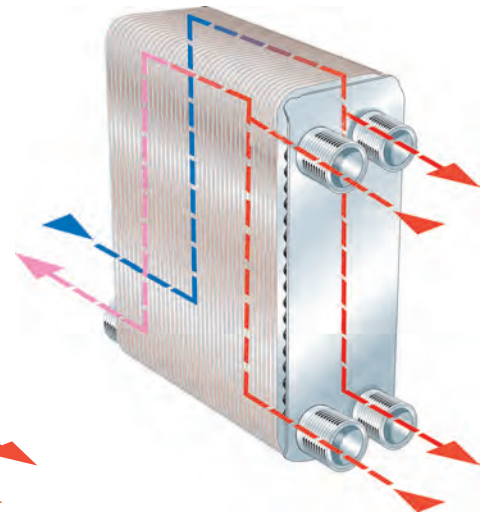

Pre/post heater



# Accessories



## Cleaning-In-Place (CIP)

All types of heat exchangers need to be cleaned regularly to remove deposits such as scale, sludge and microorganisms. Alfa Laval CIP is a convenient solution that carefully removes the deposit on all heat transfer surfaces in the heat exchanger. Alfa Laval CIP 200L and CIP 400L are manufactured in stainless steel using high-quality components (pumps, valves etc.) according to ISO 9001 and with the CE-mark. The smaller units, Alfa Laval CIP 20 and CIP 40, are made of industrial-grade plastic. Alfa Laval CIP is mobile due to its compact design. The units have reversible flow, and Alfa Laval CIP 200L and CIP 400L also have a built-in heater. All cleaning detergents used by Alfa Laval are environmentally friendly and do not damage the equipment.



## Insulation

The heat exchanger insulation is easily assembled and dismantled. The Alfa Laval insulation provides protection from the heat pack and the climate in the operating room will be dry and not too hot. Alfa Laval insulations are available for both heating and cooling applications as well as for various temperature requirements.

## Feet and mounting brackets

Larger units can be delivered with feet or mounting brackets. These make the installation work easier and minimize stresses in the connected pipes. The unit can also be bolted to the floor. CB30 and CB60 can be wall-mounted using the standard feet frame. CB200, CB300 and CB400 are always supplied with feet and a lifting hook to ensure safe and functional installation.

## Couplings for welding or soldering

The couplings fit on the threaded connections of the units. Future service is then facilitated by dismantling the heat exchanger from the pipes via the couplings. This connection is approved in most countries when weld or flange connection is required. A flat washer is used as sealing between the coupling and the connections.



Insulation



Feet and mounting brackets

# Instructions for use



## Start-up procedure

1. Before starting any pump, check whether instructions exist stating which pump should be started first.
2. Check that the valve between the pump and the heat exchanger is closed.
3. Check that the valve at the exit, if there is one, is fully open.
4. Open the ventilation.
5. Start the pump.
6. Open the valve slowly.
7. When all the air is out, close the ventilation.
8. Repeat the procedure for the other side.

## Shut-down procedure

1. First establish whether instructions exist as to which side should be stopped first.
2. Slowly close the valve controlling the flow rate of the pump you are about to stop.
3. When the valve is closed, stop the pump.
4. Repeat the procedure for the other side.

## Installation instructions

In industrial applications it is, from a performance point of view, recommended to install the heat exchanger so that a counter-current flow is obtained. It does not matter if the heat exchanger is mounted vertically or horizontally, as long as no change of phase takes place (evaporation/condensation). If drainage of the heat exchanger is needed for some reason, please take this into consideration when positioning the heat exchanger. The heat exchanger can be mounted with brackets or standing on feet supplied by Alfa Laval. It is important to minimize vibrations or pulsations from the pipes to the heat exchanger. The usage of flexible hoses is one way of reducing stresses caused by vibrations, and stresses from the piping system.

## Operation

Adjustments in flow rates to maintain correct temperatures or pressure drops should be made slowly in order to prevent pressure shocks to the system. Therefore fast-closing valves should not be used unless the pipes in the system are very short. Problems with keeping the performance of the heat exchanger may be caused by changing temperature conditions, changing flow rates or by fouling.

## Service efficiency

The heat transfer through the plates can be seriously reduced by the formation of deposits of various kinds on the plate surfaces. Even if the highly turbulent flow gives a strong resistance to the formation of deposits the turbulence can not completely eliminate fouling. Thanks to CIP (Cleaning In Place) it is possible to remove calcium deposits and other forms of scaling from the plate surfaces in an easy and effective way. Different cleaning solutions can be used depending on the type of deposits. Alfa Laval has a worldwide service organisation. Service is available in 130 countries at 15 major service centres and a network of service stations around the globe.





# Technical specifications

## Brazed plate heat exchanger (BHE) data and dimensions

	CBH16	CBH18	CB20	CB30	CB60
Channel type	H, A	H, A	H	H, M, L	H, M, L
Max./min. design temperature (°C)	225/-160	150/-50	225/-196	225/-196	175/-196
Max. design pressure at 150° C (S3-S4/S1-S2) (bar) *	32/32	32/32	16/16	36/36	36/36
Volume/channel (S3-S4/S1-S2) (litres)	0.027 (H) <sup>4)</sup>	0.038 (H) <sup>5)</sup>	0.028	0.054	0.103 (H) <sup>6)</sup>
Max. flowrate (S3-S4/S1-S2) (m <sup>3</sup> /h) **	3.6	3.6	8.9	14.5	14.5
Height, a (mm)	211	316	324	313	527
Width, b (mm)	74	74	94	113	113
Vertical connection distance, c (mm)	172	278	270	250	466
Horizontal connection distance, d (mm)	40	40	46	50	50
Plate pack length, A (mm)	(n x 2.16) + 8	(n x 2.16) + 8	(n x 1.5) + 8	(n x 2.31) + 13	(n x 2.35) + 13
Weight empty (kg) ***	(n x 0.04) + 0.27	(n x 0.07) + 0.4	(n x 0.08) + 0.6	(n x 0.1) + 1.2	(n x 0.18) + 2.1
Standard connection, external thread (in)	3/4"	3/4"	1"	1 1/4" / 1"	1 1/4" / 1"
Plate material	AISI 316	AISI 316	AISI 316	AISI 316	AISI 316
Connection material	AISI 316	AISI 316	AISI 316	AISI 316	AISI 316
Brazing material	Copper	Copper	Copper	Copper	Copper
Max. number of plates	60	60	110	150	150

	CB110 <sup>8)</sup>	CB112	CB200 (CBH200)	CB300	CB400
Channel type	H, L, M	H, L, M, AM, AH	H, L, M	H, L, M	H, L
Max./min. design temperature (°C)	225/-196	225/-196	225/-196	225/-196	225/-196
Max. design pressure at 150° C (S3-S4/S1-S2) (bar) *	32/32	32/32	26/26	27/16	32/27
Volume/channel (S3-S4/S1-S2) (litres)	0.21	0.18 <sup>7)</sup>	0.51	0.58/0.69	0.74
Max. flowrate (S3-S4/S1-S2) (m <sup>3</sup> /h) **	51	34/63	128	200	200
Height, a (mm)	491	618	740	990	990
Width, b (mm)	250	191	323	365	390
Vertical connection distance, c (mm)	378	519	622	816/861	825
Horizontal connection distance, d (mm)	138	92	205	213.5	225
Plate pack length, A (mm)	(n x 2.2) + 12	(n x 2.05) + 15	(n x 2.7) + 11 / (n x 2.7) + 14	(n x 2.62) + 11	(n x 2.56) + 14
Weight empty (kg) ***	(n x 0.38) + 13	(n x 0.35) + 4.8	(n x 0.6) + 12 / (n x 0.6) + 14	(n x 1.26) + 21	(n x 1.35) + 24
Standard connection, external thread (in)	ISO G2" / 2 1/2"	3" weld/2"	3"	4" / 2 1/2"	4"
Plate material	AISI 316	AISI 316	AISI 316	AISI 316	AISI 316
Connection material	AISI 316	AISI 316	AISI 316	AISI 316	AISI 316
Brazing material	Copper	Copper	Copper	Copper	Copper
Max. number of plates	300	300	230	250	270

## Dedicated oil cooler (DOC) data and dimensions

	DOC16	DOC20	DOC30	DOC60	DOC110	DOC112	DOC112HF
Channel type	H, A	H	H	H, L	H, M, L	H, L	H, AH, AM
Max/Min design temperature (°C)	225/-160	225/-196	225/-196	225/-196	225/-196	225/-196	225/-196
Max design pressure at 150° C (S3-S4/S1-S2) (bar) *	32/32	16/16	36/36	36/36	32/32	32/32	32/32
Volume/channel (S3-S4/S1-S2) (litres)	0,027 (H) <sup>4)</sup>	0,028	0,054	0,103	0,21	0,18	0,2/0,16 <sup>2)</sup>
Max flowrate (S3-S4/S1-S2) (m <sup>3</sup> /h) **	4,1	8,9	14,5	14,5	51	51	51
Height, a (mm)	210	324	313	527	616	616	616
Width, b (mm)	74	94	113	113	191	191	191
Vertical connections distance, c (mm)	172	270	250	466	519	519	519
Horizontal connections distance, d (mm)	42	46	50	50	92	92	92
Plate pack length, A (mm)	(n x 2,16) + 8,5	(n x 1,5) + 8	(n x 2,31) + 13	(n x 2,32) + 13	(n x 2,56) + 15	(n x 2,07) + 16	(n x 2,06) + 16 <sup>3)</sup>
Weight empty (kg) ***	(n x 0,04) + 0,27	(n x 0,08) + 0,6	(n x 0,1) + 1,2	(n x 0,18) + 2,1	(n x 0,32) + 4,82	(n x 0,35) + 4,8	(n x 0,35) + 4,8
Standard connections, flange with internal thread (in)	3/4"	3/4" / 1"	3/4" / 1 1/4"	3/4" / 1 1/4"	1" / 1 1/2"	1" / 1 1/2"	1 1/4" / 2 1/2"
Plate material	AISI 316	AISI 316	AISI 316	AISI 316	AISI 316	AISI 316	AISI 316
Connection material	AISI 304	AISI 304	AISI 304	AISI 304	AISI 304	AISI 304	AISI 304
Brazing material	Copper	Copper	Copper	Copper	Copper	Copper	Copper
Max. number of plates	60	110	100	120	240	300	300

\*) According to PED

\*\*) Water at 5 m/s (connection velocity)

\*\*) excluding connections n = number of plates

1) M and L channels 29/28 bar

2) E channel 0.18/0.18; A channel 0.18/0.25

3) A channels (n x 2.5) + 10, E channels (n x 2.2) + 10

4) A channel (0.030/0.024)

5) A channel (0.042/0.035)

6) L and M channels 0.13

7) AH and AM channels 0.20/0.16

8) Released during 2012







## Brazed plate heat exchangers range

<p><b>DOC16</b></p>	<p><b>DOC30</b></p>	<p><b>DOC60</b></p>	<p><b>DOC110</b></p>
<p>Read all about it on page 7:13</p>	<p>Read all about it on page 7:15</p>	<p>Read all about it on page 7:17</p>	<p>Read all about it on page 7:19</p>
			
<p><b>DOC112</b></p>	<p><b>DOC112HF</b></p>	<p><b>CB16/CBH16</b></p>	<p><b>CB18/CBH18</b></p>
<p>Read all about it on page 7:21</p>	<p>Read all about it on page 7:23</p>	<p>Read all about it on page 7:25</p>	<p>Read all about it on page 7:27</p>
			
<p><b>CB20</b></p>	<p><b>CB30/CBH30</b></p>	<p><b>CB60/CBH60</b></p>	<p><b>CB110/CBH110</b></p>
<p>Read all about it on page 7:29</p>	<p>Read all about it on page 7:31</p>	<p>Read all about it on page 7:33</p>	<p>Read all about it on page 7:35</p>
			





CB112/CBH112	CB200/CBH200	CB300/CBH300	CB400
Read all about it on page 7:37	Read all about it on page 7:39	Read all about it on page 7:41	Read all about it on page 7:43
 A vertical, rectangular heat exchanger with a silver-colored metal body and a reddish-brown copper-colored top and bottom section. It has two ports on the top and two on the bottom.	 A vertical, rectangular heat exchanger similar to the CB112 model, but with a four-legged stainless steel support base. It has two ports on the top and two on the bottom.	 A vertical, rectangular heat exchanger similar to the CB200 model, but with a four-legged stainless steel support base. It has two ports on the top and two on the bottom.	 A vertical, rectangular heat exchanger similar to the CB300 model, but with a four-legged stainless steel support base. It has two ports on the top and two on the bottom.



## DOC16

### Brazed plate heat exchanger for oil cooling

#### General information

Alfa Laval introduced its first brazed plate heat exchanger in 1977 and has since continuously developed and optimized its performance and reliability.

Brazing the stainless steel plates together eliminates the need for gaskets and thick frame plates, which makes the heat exchanger compact and saves material. The brazing material seals and holds the plates together at the contact points ensuring optimal heat transfer efficiency and pressure resistance. Using advanced design technologies and extensive verification guarantees the highest performance and longest possible service lifetime.

The Dedicated Oil Cooler (DOC) brazed plate heat exchangers are specifically designed for hydraulic oil cooling applications. The connection flanges give a robust construction that can withstand tough operating conditions.

#### Typical applications

Hydraulic oil cooling

#### Capacity range

DOC16 cover capacities from 10 up to 16 kW. Based on standard components and a modular concept, each unit is custom-designed for each specific installation.

#### Particulars required for quotation

To enable Alfa Laval's representative to make a specific quotation, specify the following particulars in your enquiry:

- Required flow rates or heat load
- Temperature program
- Physical properties of liquids in question
- Desired working pressure
- Maximum permitted pressure drop



DOC16 - PED approval pressure/temperature graph

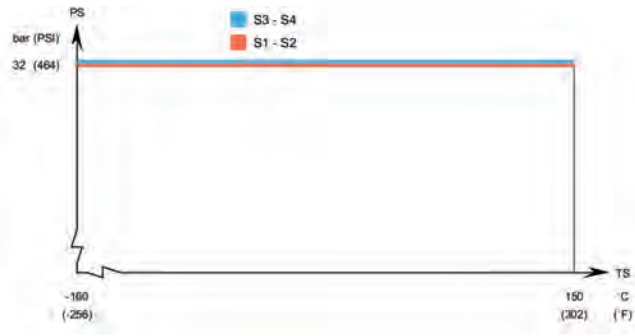

Standard dimensions and weight

A measure mm =  $8.5 + (2.16 * n)$  ( $\pm 2$  mm or  $\pm 2.5$  %)  
 A measure inch =  $0.33 + (0.09 * n)$  ( $\pm 0.08$  inch or  $\pm 2.5$  %)  
 Weight\*\* kg =  $0.27 + (0.04 * n)$   
 Weight\*\* lb =  $0.59 + (0.09 * n)$   
 (n = number of plates)  
 \*\* Excluding connections

Standard data

Min. working temperature	see graph
Max. working temperature	see graph
Min. working pressure	vacuum
Max. working pressure	see graph
Volume per channel, litres (ga)	0.027 (0.007)
Max. particle size mm (inch)	1.1 (0.04)
Max. flowrate* m <sup>3</sup> /h (gpm)	4.1 (18.04)
Min. nbr of plates	4
Max. nbr of plates	60

\* Water at 5 m/s (16.4 ft/s) (connection velocity)

Standard materials

Cover plates	Stainless steel
Connections	Stainless steel
Plates	Stainless steel
Brazing filler	Copper

Standard dimensions  
mm (inch)

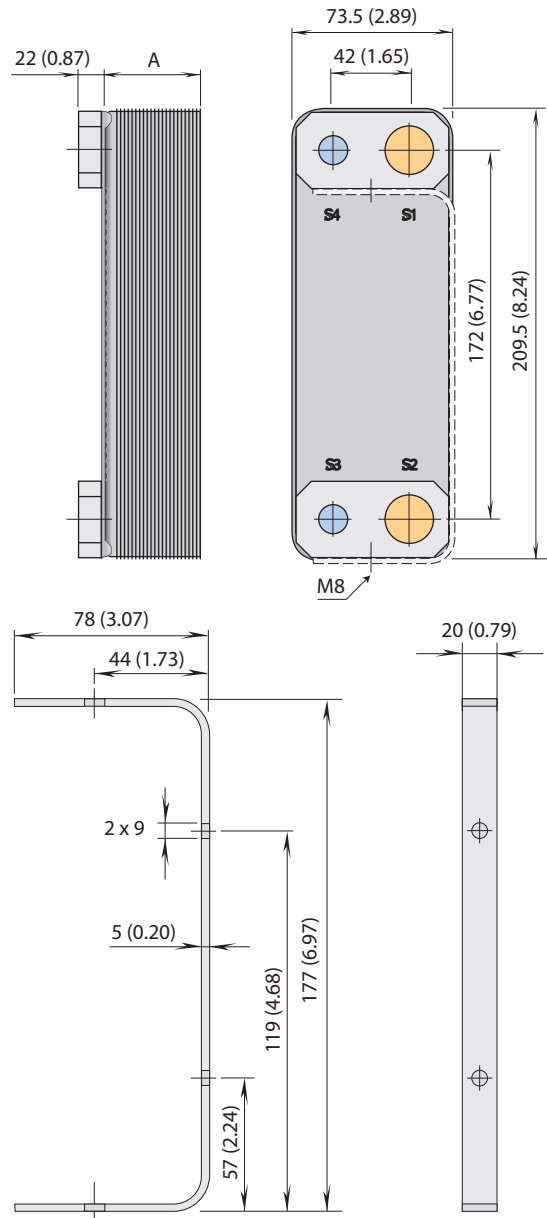

For exact values please contact your local Alfa Laval representative

How to contact Alfa Laval

Up-to-date AlfaLaval contact details for all countries are always available on our website on [www.alfalaval.com](http://www.alfalaval.com)



## DOC30

### Brazed plate heat exchanger for oil cooling

#### General information

Alfa Laval introduced its first brazed plate heat exchanger in 1977 and has since continuously developed and optimized its performance and reliability.

Brazing the stainless steel plates together eliminates the need for gaskets and thick frame plates, which makes the heat exchanger compact and saves material. The brazing material seals and holds the plates together at the contact points ensuring optimal heat transfer efficiency and pressure resistance. Using advanced design technologies and extensive verification guarantees the highest performance and longest possible service lifetime.

The Dedicated Oil Cooler (DOC) brazed plate heat exchangers are specifically designed for hydraulic oil cooling applications. The connection flanges give a robust construction that can withstand tough operating conditions.

#### Typical applications

Hydraulic oil cooling

#### Capacity range

DOC30 cover capacities from 10 up to 100 kW. Based on standard components and a modular concept, each unit is custom-designed for each specific installation.

#### Particulars required for quotation

To enable Alfa Laval's representative to make a specific quotation, specify the following particulars in your enquiry:

- Required flow rates or heat load
- Temperature program
- Physical properties of liquids in question
- Desired working pressure
- Maximum permitted pressure drop





**DOC30 - PED approval pressure/temperature graph\***

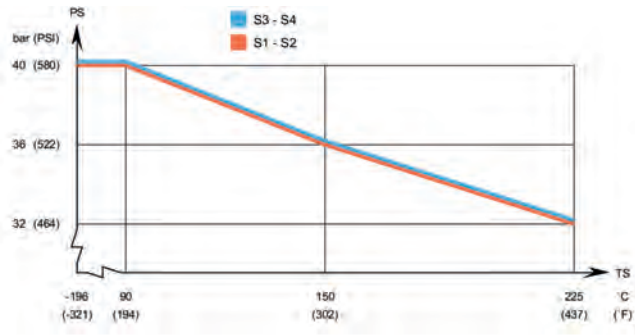

**DOC30 - UL approval pressure/temperature graph\***



**Standard dimensions and weight\***

- A measure mm =  $13 + (2.31 * n)$  ( $\pm 2$  mm or  $\pm 1.5$  %)
- A measure inch =  $0.51 + (0.09 * n)$  ( $\pm 0.08$  inch or  $\pm 1.5$  %)
- Weight\*\* kg =  $1.2 + (0.11 * n)$
- Weight\*\* lb =  $2.65 + (0.24 * n)$

(n = number of plates)  
 \* Excluding connections

**Standard data**

Min. working temperature	see graph
Max. working temperature	see graph
Min. working pressure	vacuum
Max. working pressure	see graph
Volume per channel, litres (ga)	0.054 (0.01)
Max. particle size mm (inch)	1 (0.04)
Max. flowrate* m <sup>3</sup> /h (gpm)	8.8 (38.72)
Min. nbr of plates	8
Max. nbr of plates	100

\* Water at 5 m/s (16.4 ft/s) (connection velocity)

**Standard materials**

Cover plates	Stainless steel
Connections	Stainless steel
Plates	Stainless steel
Brazing filler	Copper

**Standard dimensions**  
mm (inch)

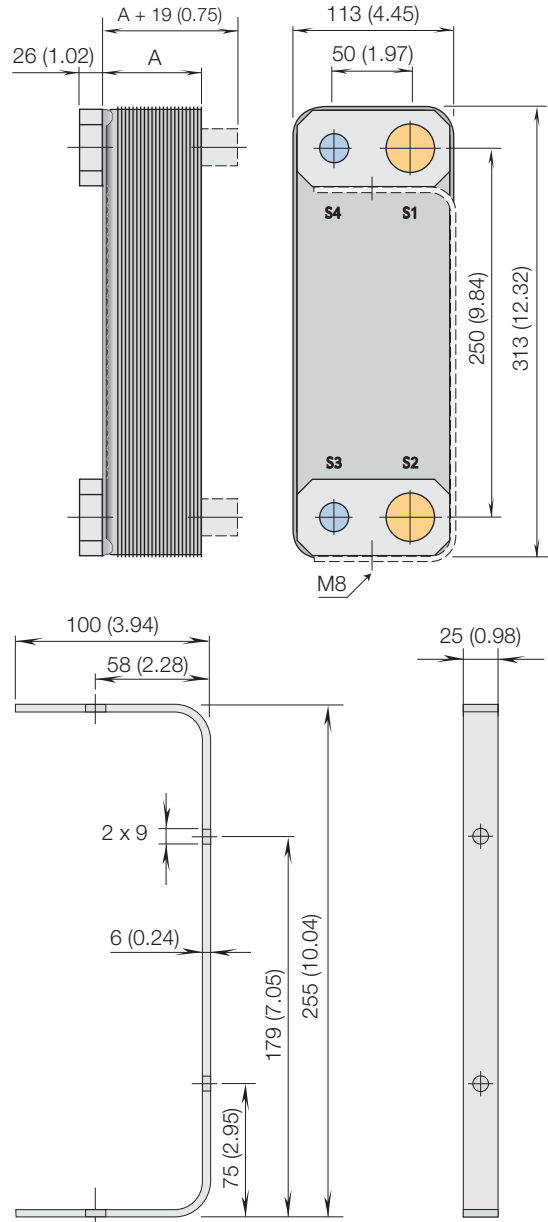

For exact values please contact your local Alfa Laval representative

**How to contact Alfa Laval**

Up-to-date AlfaLaval contact details for all countries are always available on our website on [www.alfalaval.com](http://www.alfalaval.com)



## DOC60

### Brazed plate heat exchanger for oil cooling

#### General information

Alfa Laval introduced its first brazed plate heat exchanger in 1977 and has since continuously developed and optimized its performance and reliability.

Brazing the stainless steel plates together eliminates the need for gaskets and thick frame plates, which makes the heat exchanger compact and saves material. The brazing material seals and holds the plates together at the contact points ensuring optimal heat transfer efficiency and pressure resistance. Using advanced design technologies and extensive verification guarantees the highest performance and longest possible service lifetime.

The Dedicated Oil Cooler (DOC) brazed plate heat exchangers are specifically designed for hydraulic oil cooling applications. The connection flanges give a robust construction that can withstand tough operating conditions.

#### Typical applications

Hydraulic oil cooling

#### Capacity range

DOC60 cover capacities from 20 up to 140 kW. Based on standard components and a modular concept, each unit is custom-designed for each specific installation.

#### Particulars required for quotation

To enable Alfa Laval's representative to make a specific quotation, specify the following particulars in your enquiry:

- Required flow rates or heat load
- Temperature program
- Physical properties of liquids in question
- Desired working pressure
- Maximum permitted pressure drop



**DOC60 - PED approval pressure/temperature graph\***

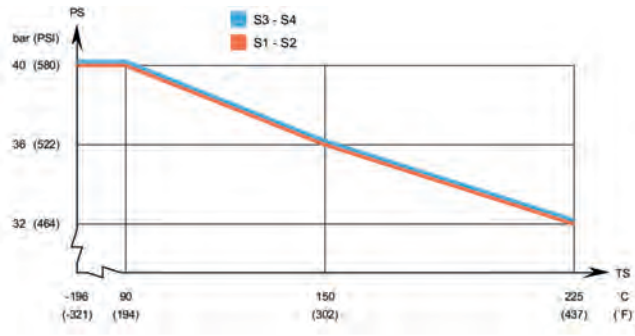

**DOC60 - UL approval pressure/temperature graph\***



**Standard dimensions and weight\***

- A measure mm =  $13 + (2.35 * n) \pm 1.5 \%$
- A measure inch =  $0.51 + (0.09 * n) \pm 0.06 \%$
- Weight\*\* kg =  $2.1 + (0.18 * n)$
- Weight\*\* lb =  $4.63 + (0.4 * n)$

(n = number of plates)  
 \* Excluding connections

**Standard data**

Min. working temperature	see graph
Max. working temperature	see graph
Min. working pressure	vacuum
Max. working pressure	see graph
Volume per channel, litres (ga)	0.10 (0.03)
Max. particle size mm (inch)	1 (0.04)
Max. flowrate* m <sup>3</sup> /h (gpm)	8.8 (38.72)
Min. nbr of plates	10
Max. nbr of plates	100

\* Water at 5 m/s (16.4 ft/s) (connection velocity)

**Standard materials**

Cover plates	Stainless steel
Connections	Stainless steel
Plates	Stainless steel
Brazing filler	Copper

**Standard dimensions**  
mm (inch)

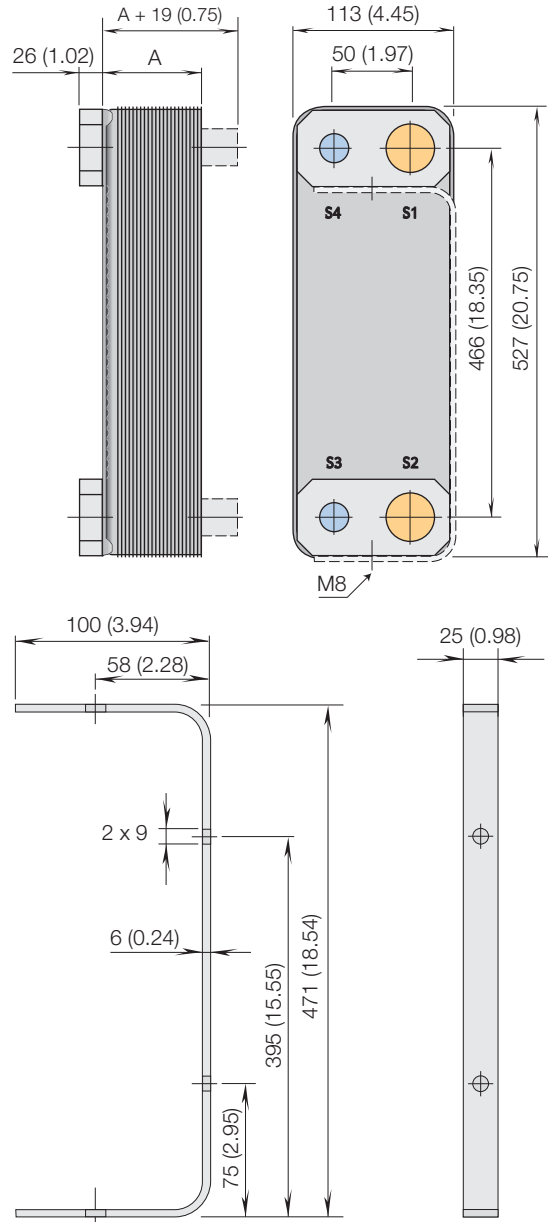

For exact values please contact your local Alfa Laval representative

**How to contact Alfa Laval**

Up-to-date AlfaLaval contact details for all countries are always available on our website on [www.alfalaval.com](http://www.alfalaval.com)



## DOC110

### Brazed plate heat exchanger for Oil Cooling

#### General information

Alfa Laval introduced its first brazed plate heat exchanger in 1977 and has since continuously developed and optimized its performance and reliability.

Brazing the stainless steel plates together eliminates the need for gaskets and thick frame plates, which makes the heat exchanger compact and saves material. The brazing material seals and holds the plates together at the contact points ensuring optimal heat transfer efficiency and pressure resistance. Using advanced design technologies and extensive verification guarantees the highest performance and longest possible service lifetime.

The Dedicated Oil Cooler (DOC) brazed plate heat exchangers are specifically designed for hydraulic oil cooling applications. The connection flanges give a robust construction that can withstand tough operating conditions.

#### Typical applications

Hydraulic oil cooling

#### Capacity range

DOC110 cover capacities from 40 up to 170 kW. Based on standard components and a modular concept, each unit is custom-designed for each specific installation.

#### Particulars required for quotation

To enable Alfa Laval's representative to make a specific quotation, specify the following particulars in your enquiry:

- Required flow rates or heat load
- Temperature program
- Physical properties of liquids in question
- Desired working pressure
- Maximum permitted pressure drop





DOC110 - PED approval pressure/temperature graph

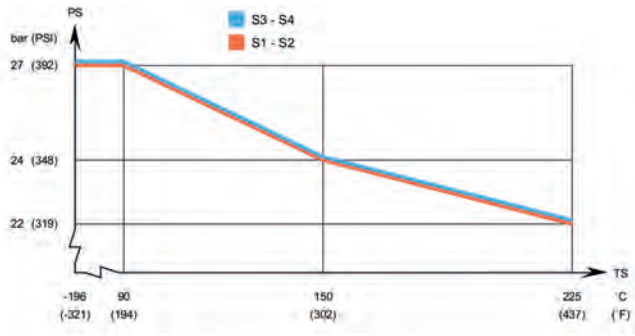

Standard dimensions and weight

- A measure mm = 15 + (2.56 \* n) (±2 mm or ±1.5 %)
- A measure inch = 0.59 + (0.1 \* n) (±0.08 inch or ±1.5 %)
- Weight\*\* kg = 4.82 + (0.32 \* n)
- Weight\*\* lb = 10.63 + (0.71 \* n)

(n = number of plates)  
 \*\* Excluding connections

Standard data

Min. working temperature	see graph
Max. working temperature	see graph
Min. working pressure	vacuum
Max. working pressure	see graph
Volume per channel, litres (ga)	0.21 (0.054)
Max. particle size mm (inch)	1.2 (0.05)
Max. flowrate* m <sup>3</sup> /h (gpm)	37 (162.8)
Min. nbr of plates	10
Max. nbr of plates	240

\* Water at 5 m/s (16.4 ft/s) (connection velocity)

Standard materials

Cover plates	Stainless steel
Connections	Stainless steel
Plates	Stainless steel
Brazing filler	Copper

Standard dimensions  
mm (inch)

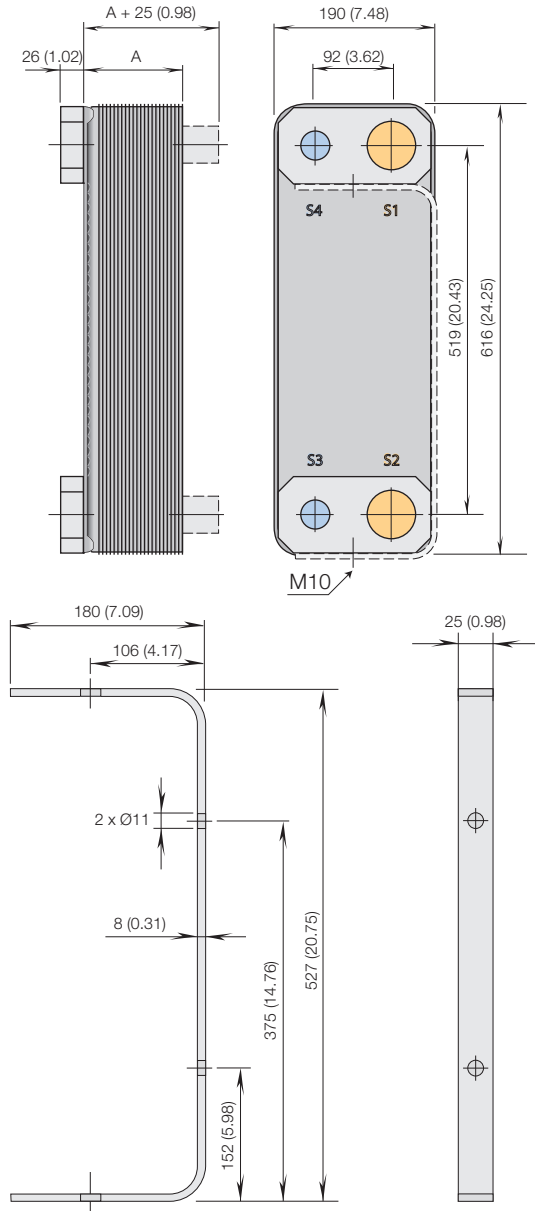

For exact values please contact your local Alfa Laval representative

How to contact Alfa Laval

Up-to-date AlfaLaval contact details for all countries are always available on our website on [www.alfalaval.com](http://www.alfalaval.com)



## DOC112

### Brazed plate heat exchanger for oil cooling

#### General information

Alfa Laval introduced its first brazed plate heat exchanger in 1977 and has since continuously developed and optimized its performance and reliability.

Brazing the stainless steel plates together eliminates the need for gaskets and thick frame plates, which makes the heat exchanger compact and saves material. The brazing material seals and holds the plates together at the contact points ensuring optimal heat transfer efficiency and pressure resistance. Using advanced design technologies and extensive verification guarantees the highest performance and longest possible service lifetime.

The Dedicated Oil Cooler (DOC) brazed plate heat exchangers are specifically designed for hydraulic oil cooling applications. The connection flanges give a robust construction that can withstand tough operating conditions.

#### Typical applications

Hydraulic oil cooling

#### Capacity range

DOC112 cover capacities from 40 up to 170 kW. Based on standard components and a modular concept, each unit is custom-designed for each specific installation.

#### Particulars required for quotation

To enable Alfa Laval's representative to make a specific quotation, specify the following particulars in your enquiry:

- Required flow rates or heat load
- Temperature program
- Physical properties of liquids in question
- Desired working pressure
- Maximum permitted pressure drop



DOC112 - PED approval pressure/temperature graph

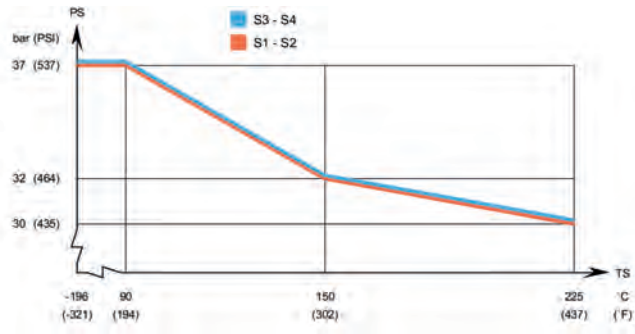

DOC112 - UL approval pressure/temperature graph

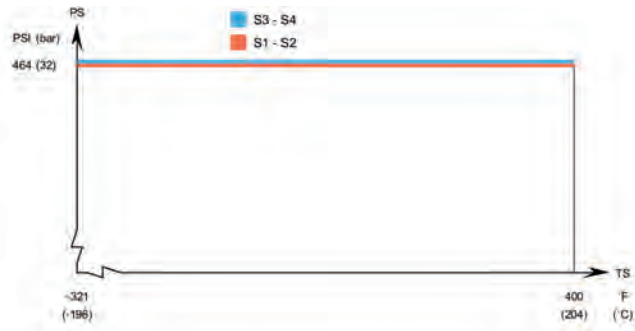

**Standard dimensions and weight\***

- A measure mm =  $16 + (2.07 * n) (\pm 3 \text{ mm or } \pm 1.5 \%)$
- A measure inch =  $0.63 + (0.08 * n) (\pm 0.12 \text{ inch or } \pm 1.5 \%)$
- Weight\* kg =  $4.82 + (0.35 * n)$
- Weight\* lb =  $10.63 + (0.77 * n)$

(n = number of plates)  
 \* Excluding connections

**Standard data**

Min. working temperature	see graph
Max. working temperature	see graph
Min. working pressure	vacuum
Max. working pressure	see graph
Volume per channel, litres (ga)	0.18 (0.046)
Max. particle size mm (inch)	1 (0.04)
Max. flowrate* m <sup>3</sup> /h (gpm)	37 (163)
Min. nbr of plates	10
Max. nbr of plates	300

\* Water at 5 m/s (16.4 ft/s) (connection velocity)

**Standard materials**

Cover plates	Stainless steel
Connections	Stainless steel
Plates	Stainless steel
Brazing filler	Copper

**Standard dimensions**  
mm (inch)

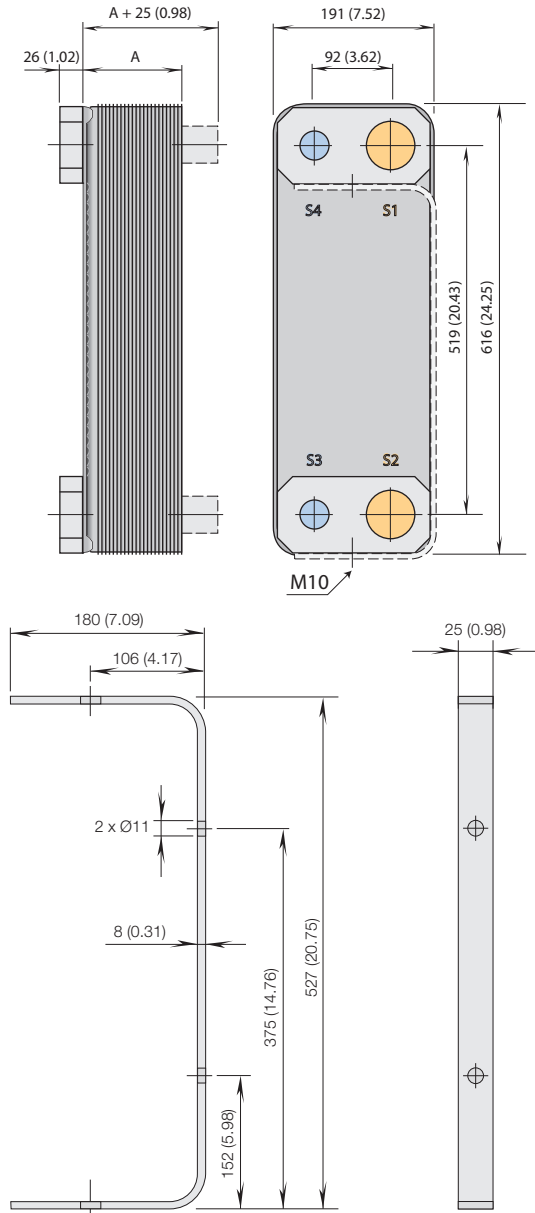

For exact values please contact your local Alfa Laval representative

**How to contact Alfa Laval**

Up-to-date AlfaLaval contact details for all countries are always available on our website on [www.alfalaval.com](http://www.alfalaval.com)



## DOC112HF

### Brazed plate heat exchanger for oil cooling

#### General information

Alfa Laval introduced its first brazed plate heat exchanger in 1977 and has since continuously developed and optimized its performance and reliability.

Brazing the stainless steel plates together eliminates the need for gaskets and thick frame plates, which makes the heat exchanger compact and saves material. The brazing material seals and holds the plates together at the contact points ensuring optimal heat transfer efficiency and pressure resistance. Using advanced design technologies and extensive verification guarantees the highest performance and longest possible service lifetime.

The Dedicated Oil Cooler (DOC) brazed plate heat exchangers are specifically designed for hydraulic oil cooling applications. The connection flanges give a robust construction that can withstand tough operating conditions.

#### Typical applications

Hydraulic oil cooling

#### Capacity range

DOC112HF cover capacities from 120 up to 360 kW. Based on standard components and a modular concept, each unit is custom-designed for each specific installation.

#### Request for quotation

To receive a quotation for brazed plate heat exchangers that meet your requirements, please provide Alfa Laval representatives with:

- Required flow rates or heat load
- Temperature program
- Physical properties of liquids in question
- Desired working pressure
- Maximum permitted pressure drop



**DOC112HF - PED approval pressure/temperature graph**

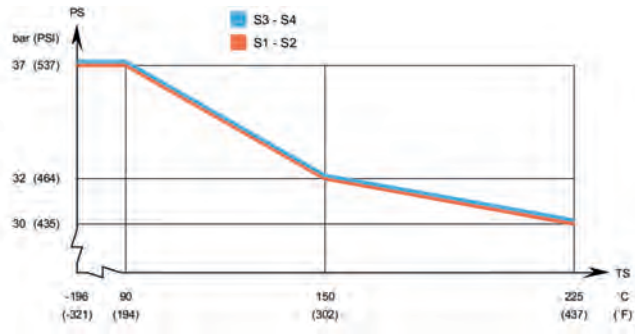

**DOC112HF - UL approval pressure/temperature graph**

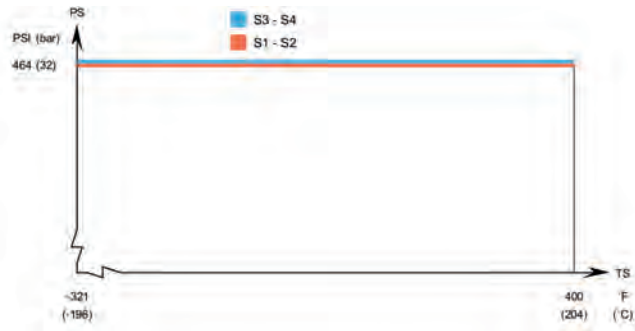

**Standard dimensions and weight\***

- A measure mm =  $16 + (2.06 * n)$  ( $\pm 3$  mm or  $\pm 1.5$  %)
- A measure inch =  $0.63 + (0.08 * n)$  ( $\pm 0.12$  inch or  $\pm 1.5$  %)
- Weight\* kg =  $4.82 + (0.35 * n)$
- Weight\* lb =  $10.63 + (0.77 * n)$

(n = number of plates)  
 \* Excluding connections

**Standard data**

Min. working temperature	see graph
Max. working temperature	see graph
Min. working pressure	vacuum
Max. working pressure	see graph
Volume per channel, litres (ga) AH	0.20 (0.052)
Volume per channel, litres (ga) H	0.16 (0.041)
Volume per channel, litres (ga) H	0.18 (0.046)
Max. particle size mm (inch)	1 (0.04)
Max. flowrate* m <sup>3</sup> /h (gpm)	51 (224)
Min. nbr of plates	10
Max. nbr of plates	300

\* Water at 5 m/s (16.4 ft/s) (connection velocity)

**Standard materials**

Cover plates	Stainless steel
Connections	Stainless steel
Plates	Stainless steel
Brazing filler	Copper

PCT00162EN 1303

Alfa Laval reserves the right to change specifications without prior notification.

**Standard dimensions**  
mm (inch)

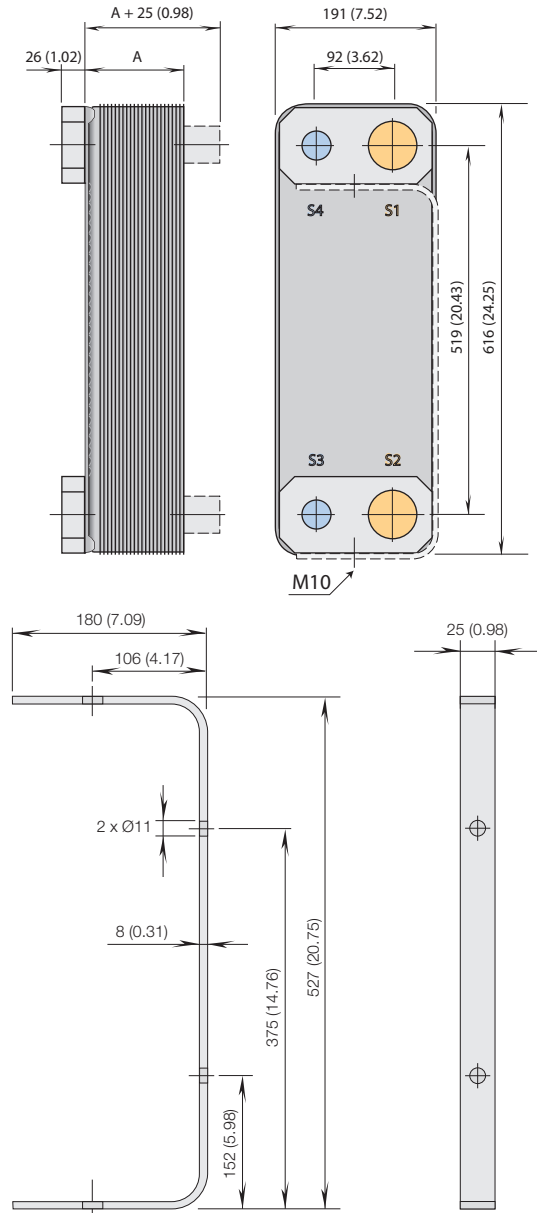

For exact values please contact your local Alfa Laval representative

**How to contact Alfa Laval**

Up-to-date AlfaLaval contact details for all countries are always available on our website on [www.alfalaval.com](http://www.alfalaval.com)





## CB16 / CBH16

### Brazed plate heat exchanger

#### General information

Alfa Laval introduced its first brazed plate heat exchanger (BHE) in 1977 and has since continuously developed and optimized its performance and reliability.

Brazing the stainless steel plates together eliminates the need for gaskets and thick frame plates. The brazing material seals and holds the plates together at the contact points ensuring optimal heat transfer efficiency and pressure resistance. The plate design guarantees the longest possible life.

The design options of the brazed heat exchanger are extensive. Different plate patterns are available for various duties and performance specifications. You can choose a standard configuration BHE, or a unit designed according to your own specific needs. The choice is entirely yours.

#### Typical applications

- HVAC heating/cooling
- Refrigerant applications
- Industrial cooling/heating
- Oil cooling

#### Working principles

The heating surface consists of thin corrugated metal plates stacked on top of each other. Channels are formed between the plates and corner ports are arranged so that the two media flow through alternate channels, usually in countercurrent flow for the most efficient heat transfer process.

#### Standard design

The plate pack is covered by cover plates. Connections are located in the front or rear cover plate. To improve the heat transfer design, the channel plates are corrugated.

#### Particulars required for quotation

To enable Alfa Laval's representative to make a specific quotation, specify the following particulars in your enquiry:

- Required flow rates or heat load
- Temperature program
- Physical properties of liquids in question
- Desired working pressure
- Maximum permitted pressure drop



#### Examples of connections\*

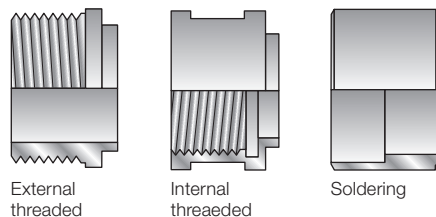

\* More connections are available on request.

CB16 - PED approval pressure/temperature graph

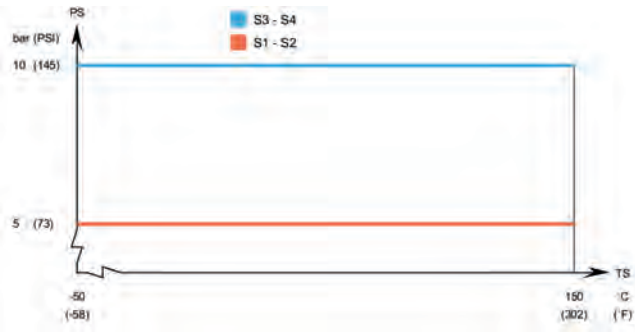

CBH16 - PED approval pressure/temperature graph

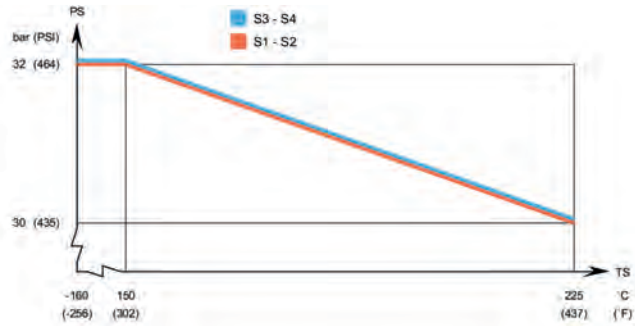

CB16 / CBH16 - UL approval pressure/temperature graph



CB16 / CBH16 - CRN approval pressure/temperature graph

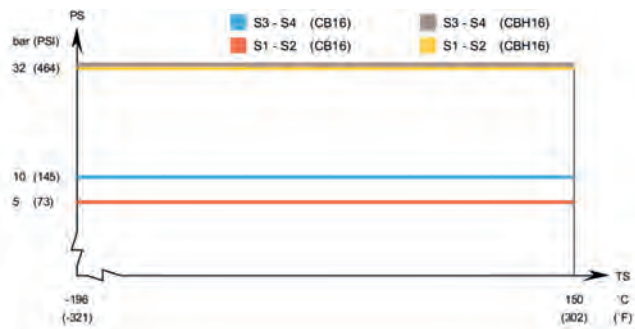

## Standard dimensions and weight

### CB16

A measure mm =  $6.25 + (2.16 * n)$  ( $\pm 3$  mm or  $\pm 3.5$  %)  
 A measure inch =  $0.25 + (0.09 * n)$  ( $\pm 0.12$  inch or  $\pm 3.5$  %)  
 Weight\*\* kg =  $0.14 + (0.04 * n)$   
 Weight\*\* lb =  $0.3 + (0.09 * n)$

### CBH16

A measure mm =  $5.7 + (2.16 * n)$  ( $\pm 3$  mm or  $\pm 3.5$  %)  
 A measure inch =  $0.22 + (0.09 * n)$  ( $\pm 0.12$  inch or  $\pm 3.5$  %)  
 Weight\*\* kg =  $0.27 + (0.04 * n)$   
 Weight\*\* lb =  $0.59 + (0.09 * n)$

(n = number of plates)

\*\* Excluding connections

## Standard data

Min. working temperature	see graph
Max. working temperature	see graph
Min. working pressure	vacuum
Max. working pressure	see graph
Volume per channel H, litres (ga)	0.027 (0.0070)
Volume per channel A, litres (ga)	0.030 (0.0078)
	0.024 (0.0063)
Max. flowrate* m <sup>3</sup> /h (gpm)	4.1 (18.04)
Min. nbr of plates	4
Max. nbr of plates	60

\* Water at 5 m/s (16.4 ft/s) (connection velocity)

## Standard materials

Cover plates	Stainless steel
Connections	Stainless steel
Plates	Stainless steel
Brazing filler	Copper

## Standard dimensions

mm (inch)

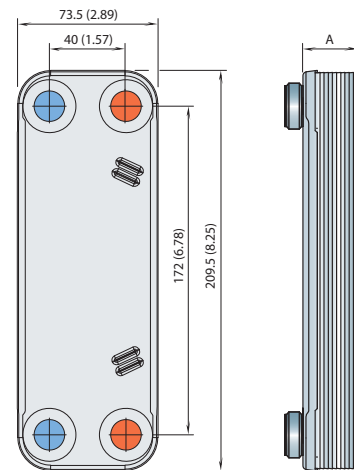

For exact values please contact your local Alfa Laval representative

### How to contact Alfa Laval

Up-to-date AlfaLaval contact details for all countries are always available on our website on [www.alfalaval.com](http://www.alfalaval.com)



## CB18 / CBH18

### Brazed plate heat exchanger

#### General information

Alfa Laval introduced its first brazed plate heat exchanger (BHE) in 1977 and has since continuously developed and optimized its performance and reliability.

Brazing the stainless steel plates together eliminates the need for gaskets and thick frame plates. The brazing material seals and holds the plates together at the contact points ensuring optimal heat transfer efficiency and pressure resistance. The plate design guarantees the longest possible life.

The design options of the brazed heat exchanger are extensive. Different plate patterns are available for various duties and performance specifications. You can choose a standard configuration BHE, or a unit designed according to your own specific needs. The choice is entirely yours.

#### Typical applications

- HVAC heating/cooling
- Refrigerant applications
- Industrial cooling/heating
- Oil cooling

#### Working principles

The heating surface consists of thin corrugated metal plates stacked on top of each other. Channels are formed between the plates and corner ports are arranged so that the two media flow through alternate channels, usually in countercurrent flow for the most efficient heat transfer process.

#### Standard design

The plate pack is covered by cover plates. Connections are located in the front or rear cover plate. To improve the heat transfer design, the channel plates are corrugated.

#### Particulars required for quotation

To enable Alfa Laval's representative to make a specific quotation, specify the following particulars in your enquiry:

- Required flow rates or heat load
- Temperature program
- Physical properties of liquids in question
- Desired working pressure
- Maximum permitted pressure drop



#### Examples of connections\*

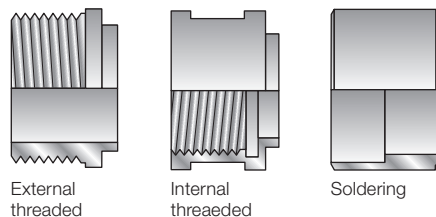

\* More connections are available on request.

CB18 / CBH18 - PED approval pressure/temperature graph H, A



CBH18 - PED approval pressure/temperature graph H

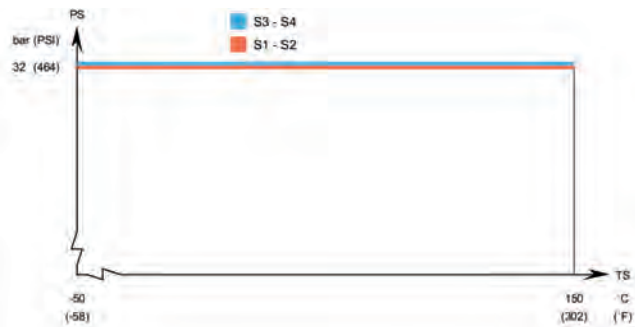

CB18 / CBH18 - UL approval pressure/temperature graph

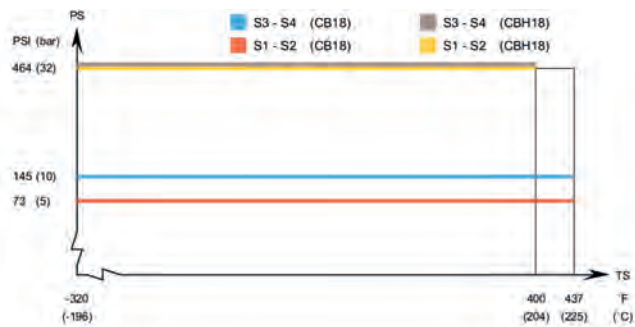

CB18 / CBH18 - CRN approval pressure/temperature graph

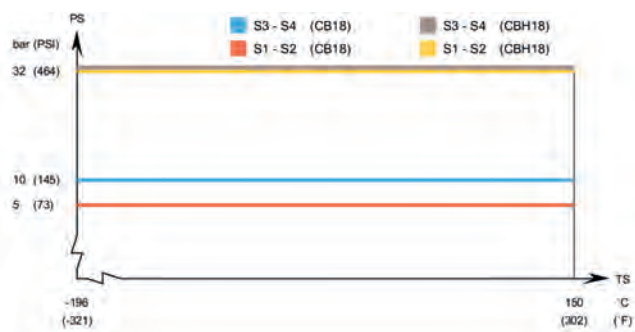

## Standard dimensions and weight

### CB18

A measure mm =  $6.25 + (2.16 * n) (\pm 3 \text{ mm or } \pm 3.5 \%)$   
 A measure inch =  $0.25 + (0.09 * n) (\pm 0.12 \text{ inch or } \pm 3.5 \%)$   
 Weight\*\* kg =  $0.22 + (0.07 * n)$   
 Weight\*\* lb =  $0.48 + (0.15 * n)$

### CBH18

A measure mm =  $5.7 + (2.16 * n) (\pm 3 \text{ mm or } \pm 3.5 \%)$   
 A measure inch =  $0.22 + (0.09 * n) (\pm 0.12 \text{ inch or } \pm 3.5 \%)$   
 Weight\*\* kg =  $0.4 + (0.07 * n)$   
 Weight\*\* lb =  $0.88 + (0.15 * n)$

(n = number of plates)

\*\* Excluding connections

## Standard data

Min. working temperature	see graph
Max. working temperature	see graph
Min. working pressure	vacuum
Max. working pressure	see graph
Volume per channel H, litres (ga)	0.038 (0.010)
Volume per channel A, litres (ga)	0.042 (0.011)
	0.035 (0.009)
Max. particle size mm (inch)	1.1 (0.04)
Max. flowrate* m <sup>3</sup> /h (gpm)	4.1 (18.04)
Min. nbr of plates	4
Max. nbr of plates	60

\* Water at 5 m/s (16.4 ft/s) (connection velocity)

## Standard materials

Cover plates	Stainless steel
Connections	Stainless steel
Plates	Stainless steel
Brazing filler	Copper

## Standard dimensions

mm (inch)

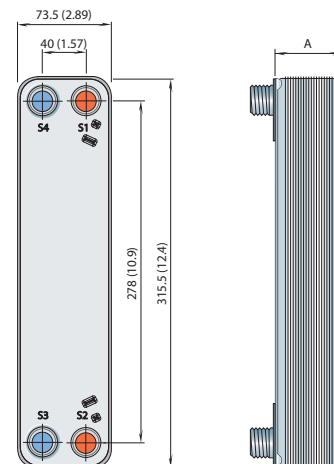

For exact values please contact your local Alfa Laval representative

### How to contact Alfa Laval

Up-to-date AlfaLaval contact details for all countries are always available on our website on [www.alfalaval.com](http://www.alfalaval.com)



# CB20

## Brazed plate heat exchanger

### General information

Alfa Laval introduced its first brazed plate heat exchanger (BHE) in 1977 and has since continuously developed and optimized its performance and reliability.

Brazing the stainless steel plates together eliminates the need for gaskets and thick frame plates. The brazing material seals and holds the plates together at the contact points ensuring optimal heat transfer efficiency and pressure resistance. The plate design guarantees the longest possible life.

The design options of the brazed heat exchanger are extensive. Different plate patterns are available for various duties and performance specifications. You can choose a standard configuration BHE, or a unit designed according to your own specific needs. The choice is entirely yours.

### Typical applications

- HVAC heating/cooling
- Refrigerant applications
- Industrial cooling/heating
- Oil cooling

### Working principles

The heating surface consists of thin corrugated metal plates stacked on top of each other. Channels are formed between the plates and corner ports are arranged so that the two media flow through alternate channels, usually in countercurrent flow for the most efficient heat transfer process.

### Standard design

The plate pack is covered by cover plates. Connections are located in the front or rear cover plate. To improve the heat transfer design, the channel plates are corrugated.

### Particulars required for quotation

To enable Alfa Laval's representative to make a specific quotation, specify the following particulars in your enquiry:

- Required flow rates or heat load
- Temperature program
- Physical properties of liquids in question
- Desired working pressure
- Maximum permitted pressure drop



### Examples of connections

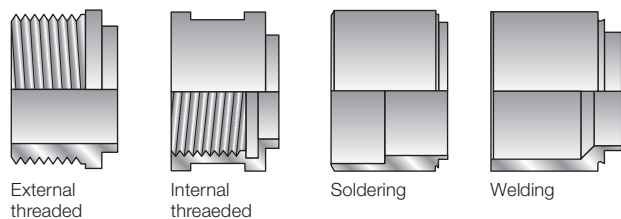

\* More connections are available on request.



**CB20 - PED approval pressure/temperature graph\***

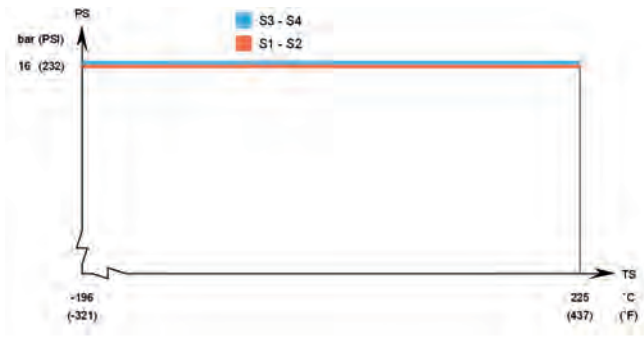

**Standard dimensions and weight\***

A measure mm =  $8 + (1.5 * n)$  (+/-3 mm)  
 A measure inch =  $0.31 + (0.06 * n)$  (+/-0.12 inch)  
 Weight\*\* kg =  $0.6 + (0.08 * n)$   
 Weight\*\* lb =  $1.32 + (0.18 * n)$   
 (n = number of plates)  
 \* Excluding connections

**Standard data**

Min. working temperature	see graph
Max. working temperature	see graph
Min. working pressure	vacuum
Max. working pressure	see graph
Volume per channel, litres (ga)	0.028 (0.007)
Max. particle size mm (inch)	0.6 (0.02)
Max. flowrate* m <sup>3</sup> /h (gpm)	8.9 (39.16)
Min. nbr of plates	10
Max. nbr of plates	110

\* Water at 5 m/s (16.4 ft/s) (connection velocity)

**Standard materials**

Cover plates	Stainless steel
Connections	Stainless steel
Plates	Stainless steel
Brazing filler	Copper

**Standard dimensions**

mm (inch)

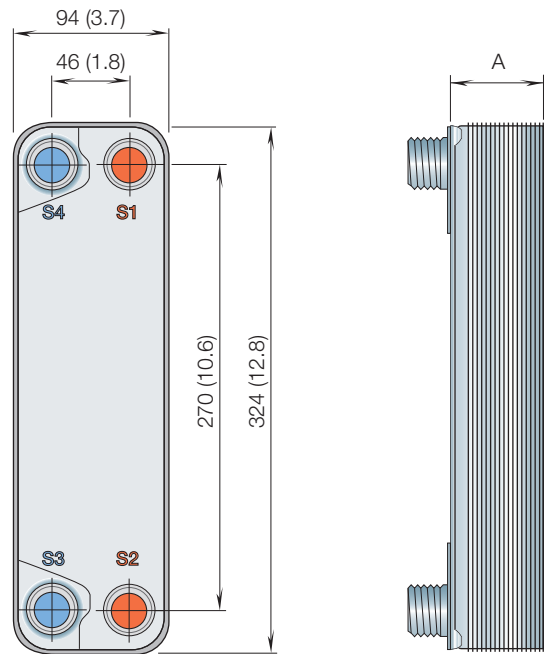

For exact values please contact your local Alfa Laval representative

**How to contact Alfa Laval**

Up-to-date AlfaLaval contact details for all countries are always available on our website on [www.alfalaval.com](http://www.alfalaval.com)



## CB30 / CBH30

### Brazed plate heat exchanger

#### General information

Alfa Laval introduced its first brazed plate heat exchanger (BHE) in 1977 and has since continuously developed and optimized its performance and reliability.

Brazing the stainless steel plates together eliminates the need for gaskets and thick frame plates. The brazing material seals and holds the plates together at the contact points ensuring optimal heat transfer efficiency and pressure resistance. The plate design guarantees the longest possible life.

The design options of the brazed heat exchanger are extensive. Different plate patterns are available for various duties and performance specifications. You can choose a standard configuration BHE, or a unit designed according to your own specific needs. The choice is entirely yours.

#### Typical applications

- HVAC heating/cooling
- Refrigerant applications
- Industrial cooling/heating
- Oil cooling

#### Working principles

The heating surface consists of thin corrugated metal plates stacked on top of each other. Channels are formed between the plates and corner ports are arranged so that the two media flow through alternate channels, usually in countercurrent flow for the most efficient heat transfer process.

#### Standard design

The plate pack is covered by cover plates. Connections are located in the front or rear cover plate. To improve the heat transfer design, the channel plates are corrugated.

#### Particulars required for quotation

To enable Alfa Laval's representative to make a specific quotation, specify the following particulars in your enquiry:

- Required flow rates or heat load
- Temperature program
- Physical properties of liquids in question
- Desired working pressure
- Maximum permitted pressure drop



#### Examples of connections

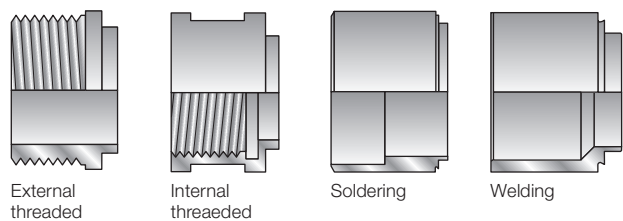

\* More connections are available on request.

CB30 / CBH30 - PED approval pressure/temperature graph

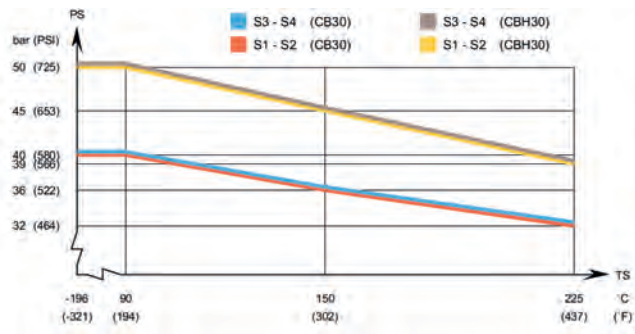

CB30 / CBH30 - UL approval pressure/temperature graph

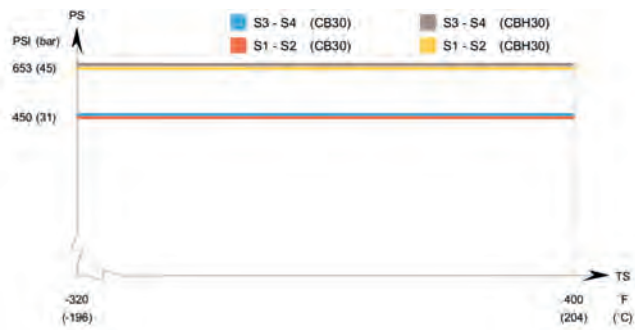

CB30 / CBH30 - KHK and KRA approval pressure/temperature graph

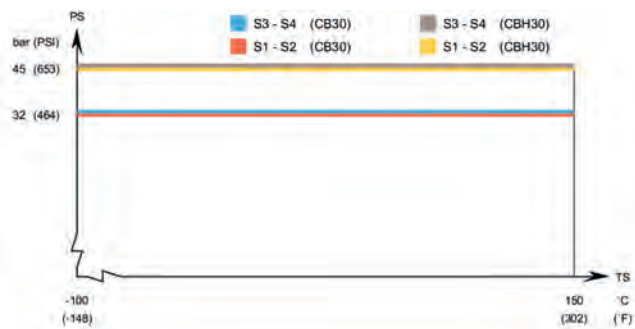

CB30 / CBH30 - CRN approval pressure/temperature graph

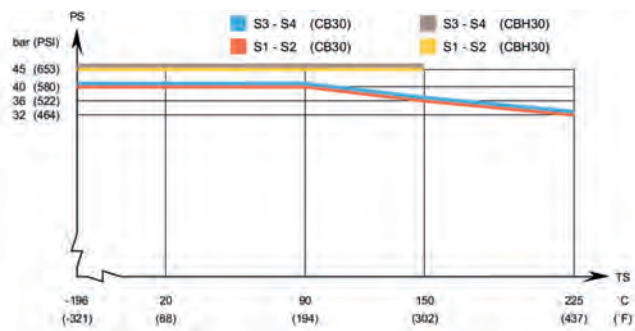

**Standard data**

Min. working temperature	see graph
Max. working temperature	see graph
Min. working pressure	vacuum
Max. working pressure	see graph
Volume per channel, litres (ga)	0.054 (0.014)
Max. particle size mm (inch)	1 (0.04)
Max. flowrate* m <sup>3</sup> /h (gpm)	14 (61.6)
Min. nbr of plates	4
Max. nbr of plates	150

\* Water at 5 m/s (16.4 ft/s) (connection velocity)

**Standard materials**

Cover plates	Stainless steel
Connections	Stainless steel
Plates	Stainless steel
Brazing filler	Copper

**Standard dimensions and weight**

**CB30**

A measure mm	=	13 + (2.31 * n) (±2 mm or ±1.5 %)
A measure inch	=	0.51 + (0.09 * n) (±0.08 inch or ±1.5 %)
Weight** kg	=	1.2 + (0.11 * n)
Weight** lb	=	2.65 + (0.24 * n)

**CBH30**

A measure mm	=	15 + (2.31 * n) ±1.5 %
A measure inch	=	0.59 + (0.09 * n) ±0.06 %
Weight** kg	=	1.35 + (0.11 * n)
Weight** lb	=	2.98 + (0.24 * n)

(n = number of plates)

\*\* Excluding connections

**Standard dimensions**

mm (inch) for exact values please contact your local Alfa laval representative

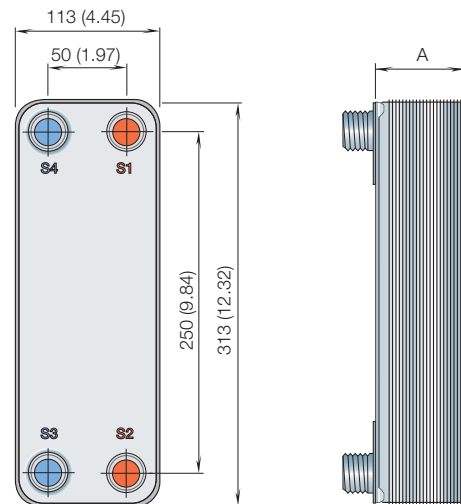

**Marine approvals**

CBM30 can be delivered with marine classification certificate (ABS, BV, CCS, Class NK, DNV, GL, LR, RINA, RMRS).

**How to contact Alfa Laval**

Up-to-date AlfaLaval contact details for all countries are always available on our website on [www.alfalaval.com](http://www.alfalaval.com)



## CB60 / CBH60

### Brazed plate heat exchanger

#### General information

Alfa Laval introduced its first brazed plate heat exchanger (BHE) in 1977 and has since continuously developed and optimized its performance and reliability.

Brazing the stainless steel plates together eliminates the need for gaskets and thick frame plates. The brazing material seals and holds the plates together at the contact points ensuring optimal heat transfer efficiency and pressure resistance. The plate design guarantees the longest possible life.

The design options of the brazed heat exchanger are extensive. Different plate patterns are available for various duties and performance specifications. You can choose a standard configuration BHE, or a unit designed according to your own specific needs. The choice is entirely yours.

#### Typical applications

- HVAC heating/cooling
- Refrigerant applications
- Industrial cooling/heating
- Oil cooling

#### Working principles

The heating surface consists of thin corrugated metal plates stacked on top of each other. Channels are formed between the plates and corner ports are arranged so that the two media flow through alternate channels, usually in countercurrent flow for the most efficient heat transfer process.

#### Standard design

The plate pack is covered by cover plates. Connections are located in the front or rear cover plate. To improve the heat transfer design, the channel plates are corrugated.

#### Particulars required for quotation

To enable Alfa Laval's representative to make a specific quotation, specify the following particulars in your enquiry:

- Required flow rates or heat load
- Temperature program
- Physical properties of liquids in question
- Desired working pressure
- Maximum permitted pressure drop



#### Examples of connections

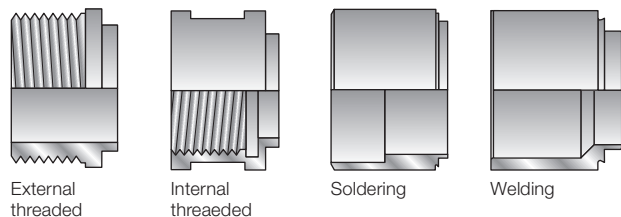

\* More connections are available on request.

CB60 and CBH60 - PED approval pressure/temperature graph\*

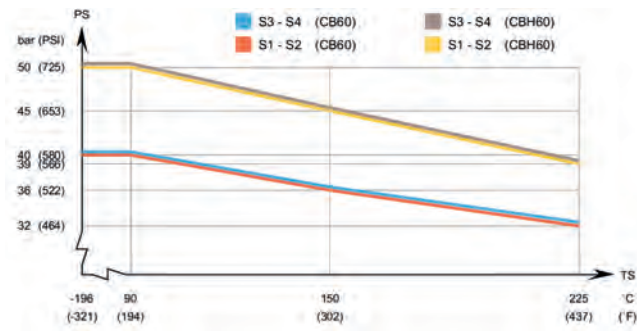

CB60 and CBH60 - UL approval pressure/temperature graph\*

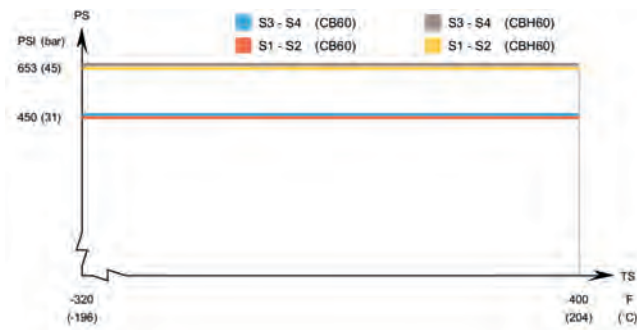

CB60 / CBH60 - KHK and KRA approval pressure/temperature graph\*

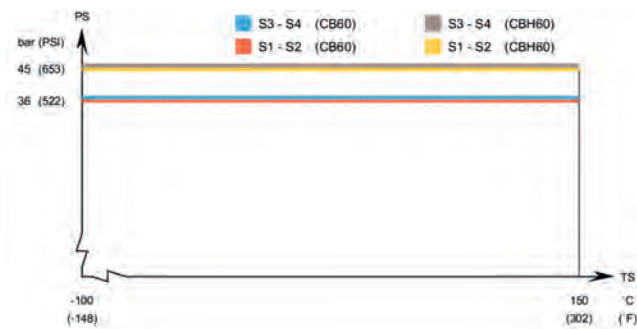

CB60 / CBH60 - CRN approval pressure/temperature graph\*

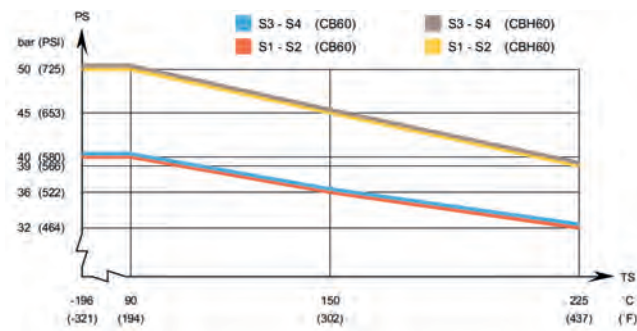

**Standard data**

Min. working temperature	see graph
Max. working temperature	see graph
Min. working pressure	vacuum
Max. working pressure	see graph
Volume per channel, litres (ga)	0.10 (0.027)
Max. particle size mm (inch)	1 (0.04)
Max. flowrate* m <sup>3</sup> /h (gpm)	14 (61.6)
Min. nbr of plates	4
Max. nbr of plates	150

\* Water at 5 m/s (16.4 ft/s) (connection velocity)

**Standard materials**

Cover plates	Stainless steel
Connections	Stainless steel
Plates	Stainless steel
Brazing filler	Copper

**Standard dimensions and weight\***

A measure mm	=	13 + (2.32 * n) (±2 mm or ±1.5 %)
A measure inch	=	0.51 + (0.09 * n) (±0.08 inch or ±1.5 %)
Weight** kg	=	2.1 + (0.18 * n)
Weight** lb	=	4.63 + (0.4 * n)

(n = number of plates)  
\* Excluding connections

**Standard dimensions**

mm (inch)

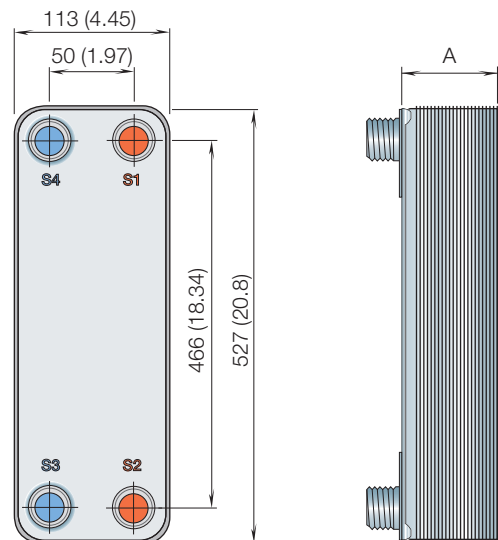

For exact values please contact your local Alfa Laval representative

**How to contact Alfa Laval**

Up-to-date AlfaLaval contact details for all countries are always available on our website on [www.alfalaval.com](http://www.alfalaval.com)





# CB110 / CBH110

## Brazed plate heat exchanger

### General information

Alfa Laval introduced its first brazed plate heat exchanger (BHE) in 1977 and has since continuously developed and optimized its performance and reliability.

Brazing the stainless steel plates together eliminates the need for gaskets and thick frame plates. The brazing material seals and holds the plates together at the contact points ensuring optimal heat transfer efficiency and pressure resistance. The plate design guarantees the longest possible life.

The design options of the brazed heat exchanger are extensive. Different plate patterns are available for various duties and performance specifications. You can choose a standard configuration BHE, or a unit designed according to your own specific needs. The choice is entirely yours.

### Typical applications

- HVAC heating/cooling
- Industrial heating/cooling
- Condensing
- Tap water
- Oil cooling
- Air dryer
- Solar heating

### Working principles

The heating surface consists of thin corrugated metal plates stacked on top of each other. Channels are formed between the plates and corner ports are arranged so that the two media flow through alternate channels, usually in countercurrent flow for the most efficient heat transfer process.

### Standard design

The plate pack is covered by cover plates. Connections are located in the front or rear cover plate. To improve the heat transfer design, the channel plates are corrugated.

### Particulars required for quotation

To enable Alfa Laval's representative to make a specific quotation, specify the following particulars in your enquiry:

- Required flow rates or heat load
- Temperature program
- Physical properties of liquids in question
- Desired working pressure
- Maximum permitted pressure drop



### Examples of connections\*

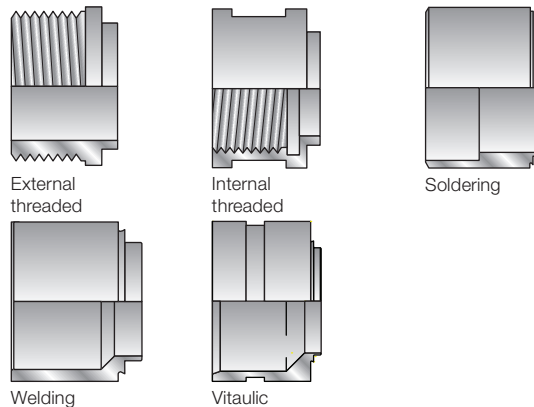

\* More connections are available on request.

CB110 - PED approval pressure/temperature graph

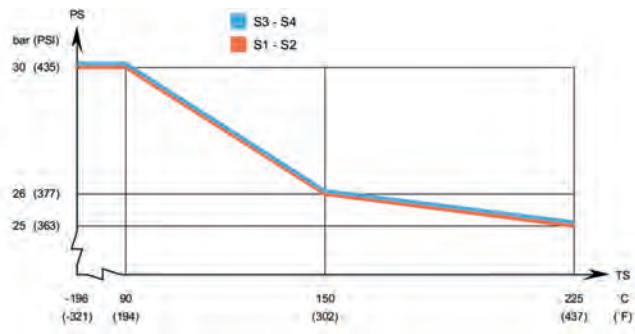

CBH110 - PED approval pressure/temperature graph  
TO BE DEFINED

**Standard dimensions and weight\***

**CB110**

- A measure mm = 15 + (2.56 \* n) (±2 mm or ±1.5 %)
- A measure inch = 0.59 + (0.1 \* n) (±0.08 inch or ±1.5 %)
- Weight\*\* kg = 4.82 + (0.32 \* n)
- Weight\*\* lb = 10.63 + (0.71 \* n)

**CBH110**

- A measure mm = 15 + (2.56 \* n) (±2 mm or ±1.5 %)
- A measure inch = 0.59 + (0.1 \* n) (±0.08 inch or ±1.5 %)
- Weight\*\* kg = 5.68 + (0.32 \* n)
- Weight\*\* lb = 12.52 + (0.71 \* n)

(n = number of plates)  
\* Excluding connections

**Standard data**

Min. working temperature	see graph
Max. working temperature	see graph
Min. working pressure	vacuum
Max. working pressure	see graph
Volume per channel H, L, M, litres (ga)	0.21 (0.05)
Max. particle size mm (inch)	1.2 (0.05)
Max. flowrate* m <sup>3</sup> /h (gpm)	51 (224)
Min. nbr of plates	10
Max. nbr of plates	240

\* Water at 5 m/s (16.4 ft/s) (connection velocity)

**Standard materials**

Cover plates	Stainless steel
Connections	Stainless steel
Plates	Stainless steel
Brazing filler	Copper

**Standard dimensions**  
mm (inch)

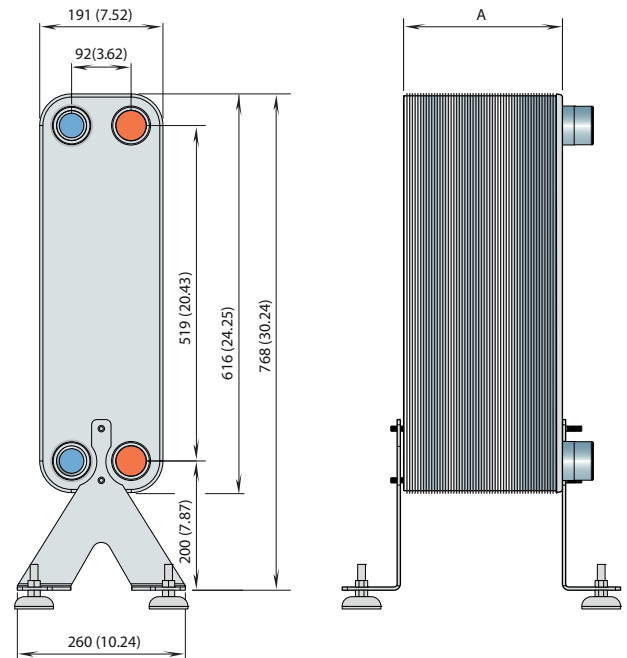

For exact values please contact your local Alfa Laval representative

**Marine approvals**

CBM110 can be delivered with marine classification certificate (ABS, BV, CCS, Class NK, DNV, GL, LR, RINA, RMRS).

**How to contact Alfa Laval**

Up-to-date AlfaLaval contact details for all countries are always available on our website on [www.alfalaval.com](http://www.alfalaval.com)



## CB112 / CBH112

### Brazed plate heat exchanger

#### General information

Alfa Laval introduced its first brazed plate heat exchanger (BHE) in 1977 and has since continuously developed and optimized its performance and reliability.

Brazing the stainless steel plates together eliminates the need for gaskets and thick frame plates. The brazing material seals and holds the plates together at the contact points ensuring optimal heat transfer efficiency and pressure resistance. The plate design guarantees the longest possible life.

The design options of the brazed heat exchanger are extensive. Different plate patterns are available for various duties and performance specifications. You can choose a standard configuration BHE, or a unit designed according to your own specific needs. The choice is entirely yours.

#### Typical applications

- HVAC heating/cooling
- Industrial heating/cooling
- Condensing
- Tap water
- Oil cooling
- Air dryer
- Solar heating

#### Working principles

The heating surface consists of thin corrugated metal plates stacked on top of each other. Channels are formed between the plates and corner ports are arranged so that the two media flow through alternate channels, usually in countercurrent flow for the most efficient heat transfer process.

#### Standard design

The plate pack is covered by cover plates. Connections are located in the front or rear cover plate. To improve the heat transfer design, the channel plates are corrugated.

#### Particulars required for quotation

To enable Alfa Laval's representative to make a specific quotation, specify the following particulars in your enquiry:

- Required flow rates or heat load
- Temperature program
- Physical properties of liquids in question
- Desired working pressure
- Maximum permitted pressure drop



#### Examples of connections\*

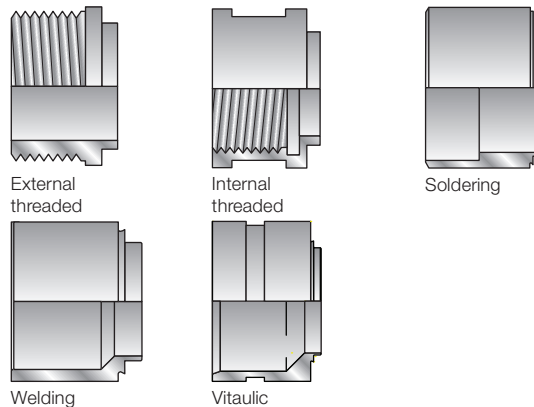

\* More connections are available on request.

**CBH112 / CBH112 - PED approval pressure/temperature graph**

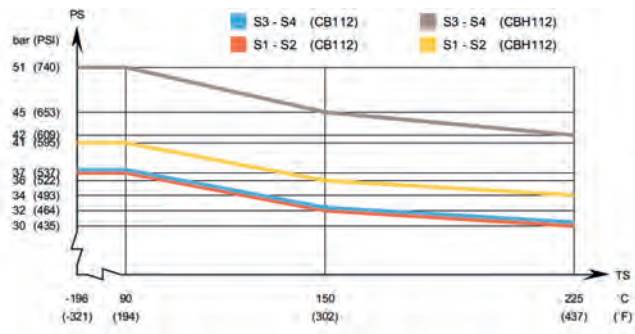

**CBH112 / CBH112 - UL approval pressure/temperature graph**

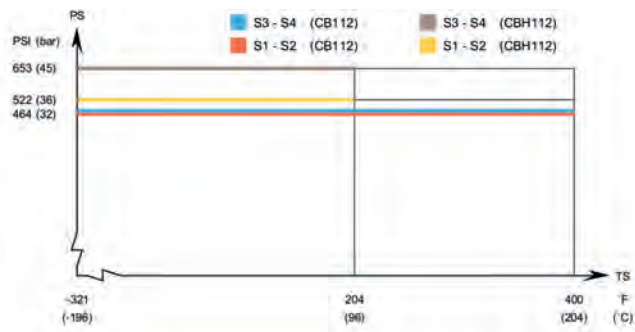

**CBH112 / CBH112 - KHK approval pressure/temperature graph**

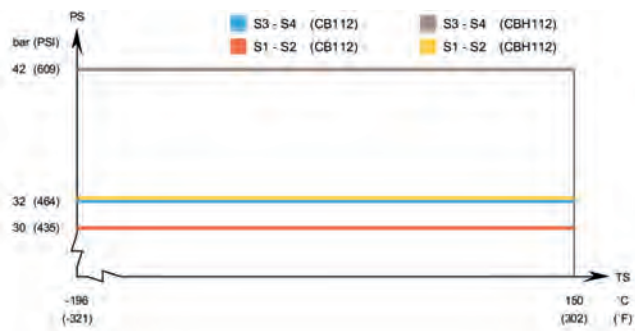

**Standard dimensions and weight\***

**CB112**

- A measure mm = 16 + (2.07 \* n) (±3 mm or ±1.5 %)
- A measure inch = 0.63 + (0.08 \* n) (±0.12 inch or ±1.5 %)
- Weight\* kg = 4.82 + (0.35 \* n)
- Weight\* lb = 10.63 + (0.77 \* n)

**CBH112**

- A measure mm = 16 + (2.07 \* n) (±3 mm or ±1.5 %)
- A measure inch = 0.63 + (0.08 \* n) (±0.12 inch or ±1.5 %)
- Weight\* kg = 5.68 + (0.35 \* n)
- Weight\* lb = 12.52 + (0.77 \* n)

(n = number of plates)

\* Excluding connections and reinforcements

**Standard data**

Min. working temperature	see graph
Max. working temperature	see graph
Min. working pressure	vacuum
Max. working pressure	see graph
Volume per channel H, L, M, litres (ga)	0.18 (0.046)
	0.20 (0.052)
Volume per channel AH, AM, litres (ga)	0.16 (0.041)
Max. particle size mm (inch)	1 (0.04)
Max. flowrate* m <sup>3</sup> /h (gpm)	51 (224.4)
Min. nbr of plates	10
Max. nbr of plates	300
* Water at 5 m/s (16.4 ft/s) (connection velocity)	

**Standard materials**

Cover plates	Stainless steel
Connections	Stainless steel
Plates	Stainless steel
Brazing filler	Copper

**Standard dimensions**

mm (inch)

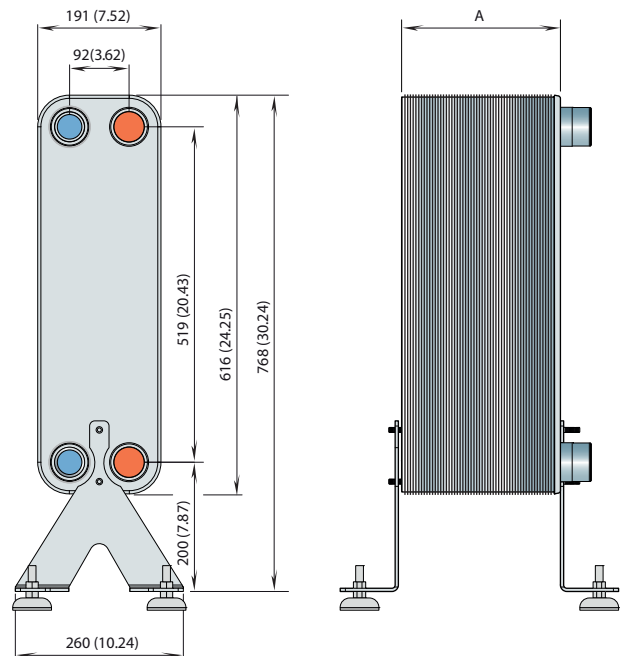

For exact values please contact your local Alfa Laval representative

**How to contact Alfa Laval**

Up-to-date AlfaLaval contact details for all countries are always available on our website on [www.alfalaval.com](http://www.alfalaval.com)



## CB200 / CBH200

### Brazed plate heat exchanger

#### General information

Alfa Laval introduced its first brazed plate heat exchanger (BHE) in 1977 and has since continuously developed and optimized its performance and reliability.

Brazing the stainless steel plates together eliminates the need for gaskets and thick frame plates. The brazing material seals and holds the plates together at the contact points ensuring optimal heat transfer efficiency and pressure resistance. The plate design guarantees the longest possible life.

The design options of the brazed heat exchanger are extensive. Different plate patterns are available for various duties and performance specifications. You can choose a standard configuration BHE, or a unit designed according to your own specific needs. The choice is entirely yours.

#### Typical applications

- Liquid/liquid applications:
- HVAC heating/cooling
  - Process heating/cooling
  - Hydraulic oil cooling
  - Oil cooling

#### Working principles

The heating surface consists of thin corrugated metal plates stacked on top of each other. Channels are formed between the plates and corner ports are arranged so that the two media flow through alternate channels, usually in countercurrent flow for the most efficient heat transfer process.

#### Standard design

The plate pack is covered by cover plates. Connections are located in the front or rear cover plate. To improve the heat transfer design, the channel plates are corrugated.

#### Particulars required for quotation

To enable Alfa Laval's representative to make a specific quotation, specify the following particulars in your enquiry:

- Required flow rates or heat load
- Temperature program
- Physical properties of liquids in question
- Desired working pressure
- Maximum permitted pressure drop



#### Examples of connections

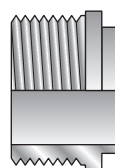

External threaded

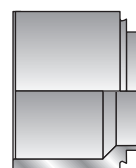

Welding

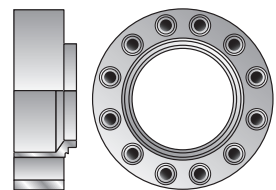

Compact flanges



CB200 - PED approval pressure/temperature graph\*

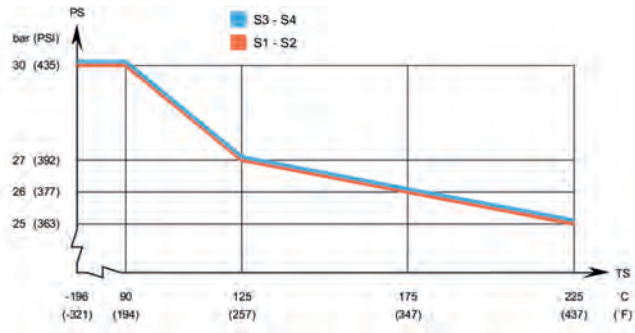

CBH200 - PED approval pressure/temperature graph\*

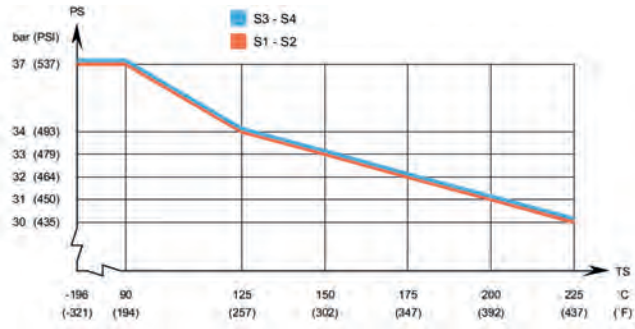

CB200 / CBH200 - ASME approval pressure/temperature graph\*

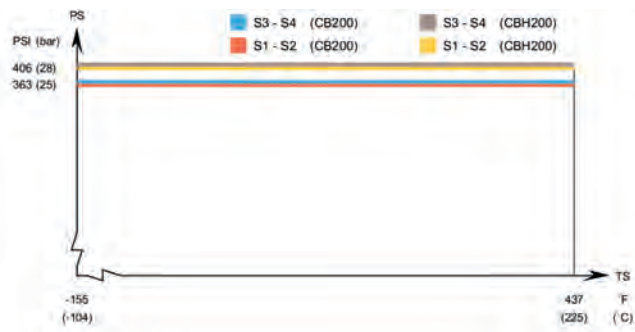

CB200 / CBH200 - CRN approval pressure/temperature graph\*

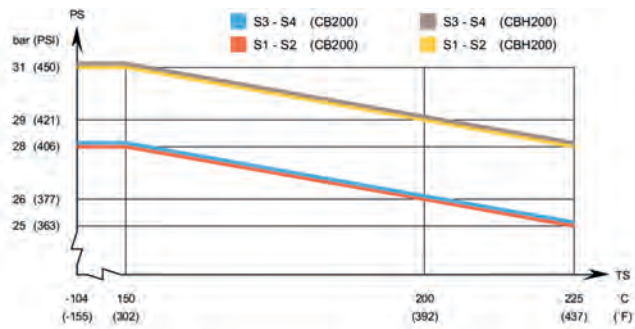

**Standard dimensions and weight\***

**CB200**  
 A measure mm = 11 + (2.7 \* n) (+/-10 mm)  
 A measure inch = 0.43 + (0.11 \* n) (+/-0.39 inch)  
 Weight\* kg = 12 + (0.6 \* n)  
 Weight\* lb = 26.46 + (1.32 \* n)

**CBH200**  
 A measure mm = 14 + (2.7 \* n) (+/-10 mm)  
 A measure inch = 0.55 + (0.11 \* n) (+/-0.39 inch)  
 Weight\* kg = 14 + (0.6 \* n)  
 Weight\* lb = 30.86 + (1.32 \* n)

(n = number of plates)  
 \* Excluding connections

**Standard data**

Min. working temperature	see graph
Max. working temperature	see graph
Min. working pressure	vacuum
Max. working pressure	see graph
Volume per channel, litres (ga)	0.51 (0.13)
Max. particle size mm (inch)	1.8 (0.07)
Max. flowrate* m <sup>3</sup> /h (gpm)	128 (561)
Min. nbr of plates	10
Max. nbr of plates	230

\* Water at 5 m/s (16.4 ft/s) (connection velocity)

**Standard materials**

Cover plates	Stainless steel
Connections	Stainless steel
Plates	Stainless steel
Brazing material	Copper

**Standard dimensions**

mm (inch)

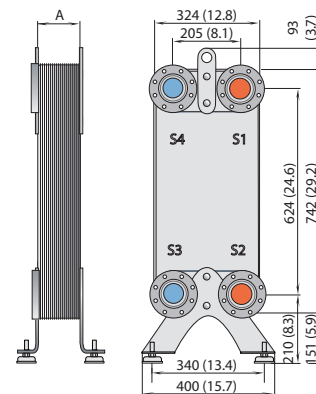

**Marine approvals**

CBM200 can be delivered with marine classification certificate (ABS, BV, CCS, Class NK, DNV, GL, LR, RINA, RMRS).

For exact values please contact your local Alfa Laval representative

**How to contact Alfa Laval**

Up-to-date AlfaLaval contact details for all countries are always available on our website on [www.alfalaval.com](http://www.alfalaval.com)



## CB300 / CBH300

### Brazed plate heat exchanger

#### General information

Alfa Laval introduced its first brazed plate heat exchanger (BHE) in 1977 and has since continuously developed and optimized its performance and reliability.

Brazing the stainless steel plates together eliminates the need for gaskets and thick frame plates. The brazing material seals and holds the plates together at the contact points ensuring optimal heat transfer efficiency and pressure resistance. The plate design guarantees the longest possible life.

The design options of the brazed heat exchanger are extensive. Different plate patterns are available for various duties and performance specifications. You can choose a standard configuration BHE, or a unit designed according to your own specific needs. The choice is entirely yours.

#### Applications

Liquid/liquid applications:

- HVAC heating/cooling
- Process heating/cooling
- Hydraulic oil cooling
- Oil cooling

#### Working principles

The heating surface consists of thin corrugated metal plates stacked on top of each other. Channels are formed between the plates and corner ports are arranged so that the two media flow through alternate channels, usually in countercurrent flow for the most efficient heat transfer process.

#### Standard design

The plate pack is covered by cover plates. Connections are located in the front or rear cover plate. To improve the heat transfer design, the channel plates are corrugated.

#### Particulars required for quotation

To enable Alfa Laval's representative to make a specific quotation, specify the following particulars in your enquiry:

- Required flow rates or heat load
- Temperature program
- Physical properties of liquids in question
- Desired working pressure
- Maximum permitted pressure drop



#### Examples of connections

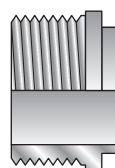

External threaded

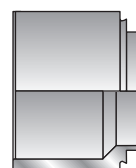

Welding

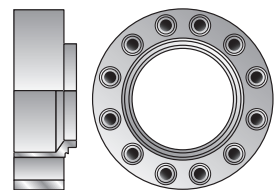

Compact flanges

CB300 / CBH300 - PED approval pressure/temperature graph\*

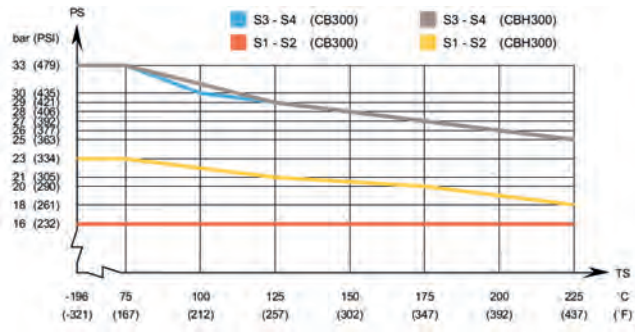

CB300 - ASME approval pressure/temperature graph\*

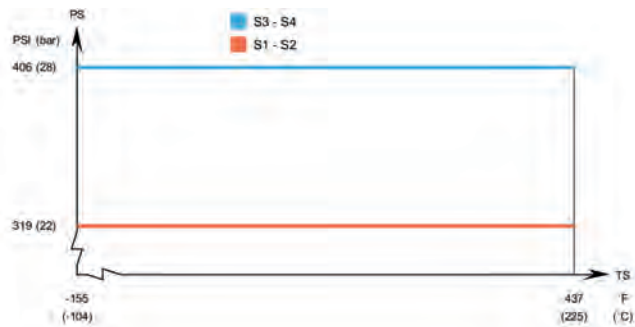

CB300 - UL approval pressure/temperature graph\*

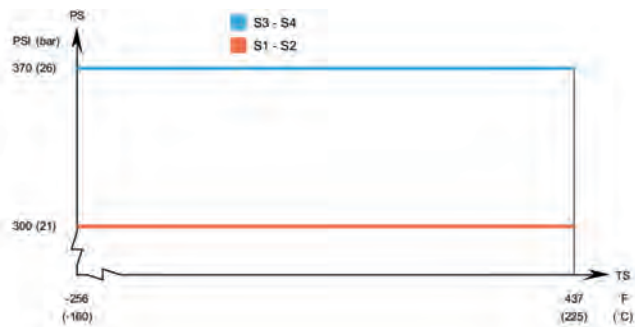

CB300 - CRN approval pressure/temperature graph\*

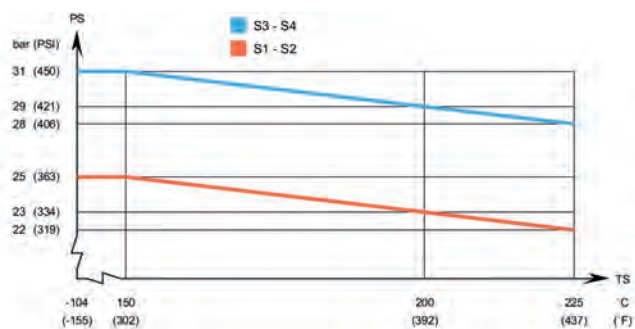

Standard data

Min. working temperature	see graph
Max. working temperature	see graph
Min. working pressure	vacuum
Max. working pressure	see graph
Volume per channel S1/S2, litres (ga)	0.69 (0.18)
Volume per channel S3/S4, litres (ga)	0.58 (0.15)
Max. particle size mm (inch)	1.8 (0.07)
Max. flowrate S1/S2 m <sup>3</sup> /h (gpm)*	200 (881)
Min. nbr of plates	10
Max. nbr of plates	250

\* Water at 5 m/s (16.4 ft/s) (connection velocity)

Standard materials

Cover plates	Stainless steel
Connections	Stainless steel
Plates	Stainless steel
Brazing material	Copper

Standard dimensions and weight\*

A measure mm	=	11 + (2.62 * n) (+/-10 mm)
A measure inch	=	0.43 + (0.1 * n) (+/-0.39 inch)
Weight* kg	=	21 + (1.26 * n)
Weight* lb	=	46.3 + (2.78 * n)

(n = number of plates)  
\* Excluding connections

Standard dimensions

mm (inch)

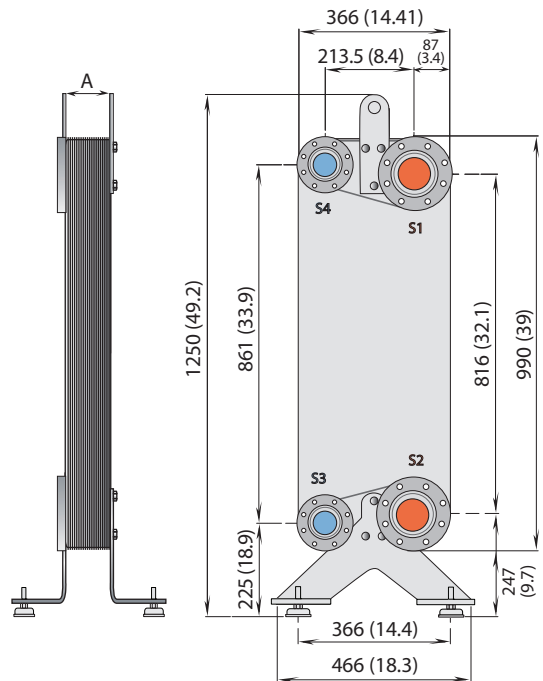

For exact values please contact your local Alfa Laval representative

How to contact Alfa Laval

Up-to-date AlfaLaval contact details for all countries are always available on our website on [www.alfalaval.com](http://www.alfalaval.com)



# CB400

## Brazed plate heat exchanger

### General information

Alfa Laval introduced its first brazed plate heat exchanger (BHE) in 1977 and has since continuously developed and optimized its performance and reliability.

Brazing the stainless steel plates together eliminates the need for gaskets and thick frame plates. The brazing material seals and holds the plates together at the contact points ensuring optimal heat transfer efficiency and pressure resistance. The plate design guarantees the longest possible life.

The design options of the brazed heat exchanger are extensive. Different plate patterns are available for various duties and performance specifications. You can choose a standard configuration BHE, or a unit designed according to your own specific needs. The choice is entirely yours.

### Typical applications

- HVAC heating/cooling
- Process heating/cooling
- Hydraulic oil cooling
- Oil cooling

### Working principles

The heating surface consists of thin corrugated metal plates stacked on top of each other. Channels are formed between the plates and corner ports are arranged so that the two media flow through alternate channels, usually in countercurrent flow for the most efficient heat transfer process.

### Standard design

The plate pack is covered by cover plates. Connections are located in the front or rear cover plate. To improve the heat transfer design, the channel plates are corrugated.

### Particulars required for quotation

To enable Alfa Laval's representative to make a specific quotation, specify the following particulars in your enquiry:

- Required flow rates or heat load
- Temperature program
- Physical properties of liquids in question
- Desired working pressure
- Maximum permitted pressure drop



### Examples of connections

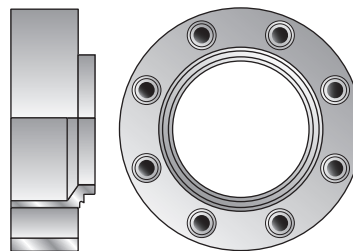

Compact flanges



Welding



Clamp

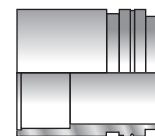

Soldering

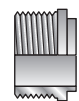

External threaded

CB400 - PED approval pressure/temperature graph\*

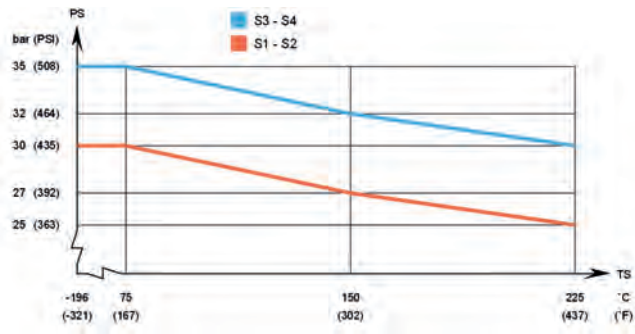

CB400 - ASME approval pressure/temperature graph\*

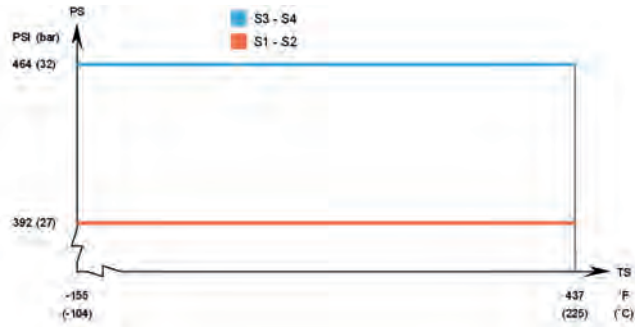

CB400 - UL approval pressure/temperature graph\*



CB400 - CRN approval pressure/temperature graph\*

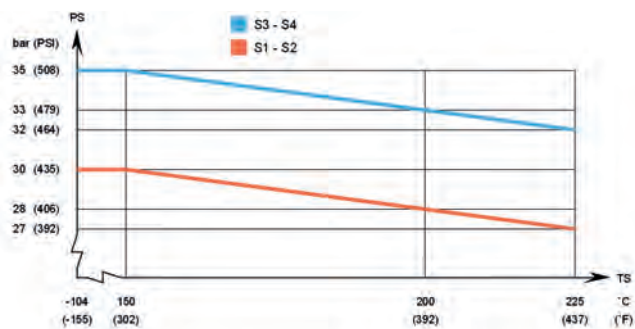

**Standard dimensions and weight\***

A measure mm = 14 + (2.56 \* n) (+/-10 mm)  
 A measure inch = 0.55 + (0.1 \* n) (+/-0.39 inch)  
 Weight\*\* kg = 24 + (1.35 \* n)  
 Weight\*\* lb = 52.91 + (2.98 \* n)

(n = number of plates)  
 \* Excluding connections

**Standard data**

Min. working temperature	see graph
Max. working temperature	see graph
Min. working pressure	vacuum
Max. working pressure	see graph
Volume per channel, litres (ga)	0.74 (0.19)
Max. particle size mm (inch)	1.8 (0.07)
Max. flowrate* m <sup>3</sup> /h (gpm)	200 (881)
Min. nbr of plates	10
Max. nbr of plates	270

\* Water at 5 m/s (16.4 ft/s) (connection velocity)

**Standard materials**

Cover plates	Stainless steel
Connections	Stainless steel
Plates	Stainless steel
Brazing filler	Copper

**Standard dimensions**

mm (inch)

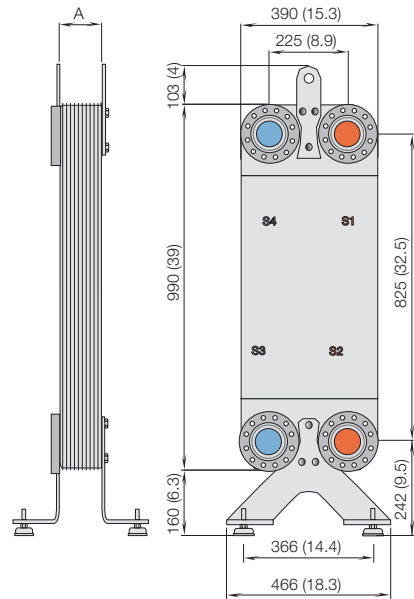

**Marine approvals**

CBM400 can be delivered with marine classification certificate (ABS, BV, CCS, Class NK, DNV, GL, LR, RINA, RMRS).

For exact values please contact your local Alfa Laval representative

**How to contact Alfa Laval**

Up-to-date AlfaLaval contact details for all countries are always available on our website on [www.alfalaval.com](http://www.alfalaval.com)





# Couplings and Counter Flanges

## Brazed and Fusion-bonded plate heat exchangers

Alfa Laval offers a wide range of accessories to brazed and fusion-bonded plate heat exchangers. This leaflet shows the couplings and counter compact flanges available directly from our stock.

The couplings are available in different standard dimensions and in different materials for welding or soldering installation.

The counter compact flanges fit our compact flanges and are available in different material for different applications.

### Coupling ISO G ¾"

Type	Nut material	Pipe material	Size	L (mm)	D (mm)	d (mm)	Item no. 2 pack	Item no. 50 pack
Welding	Carbon steel	Carbon steel	DN15	23	21.3	-	3456632401	3456632402
Soldering	Carbon steel	Brass	Cu18	16	18	15	3456634601	-
Welding	Carbon steel	Stainless steel	DN15	23	21.3	-	3456632801	-

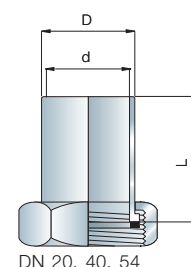

### Coupling ISO G 1"

Type	Nut material	Pipe material	Size	L (mm)	D (mm)	d (mm)	Item no. 2 pack	Item no. 50 pack
Welding	Carbon steel	Carbon steel	DN20	33	26.9	-	3456632201	3456632202
Welding	Carbon steel	Carbon steel	DN25	31	33.7	26.9	3456632701	3456632702
Soldering	Carbon steel	Brass	Cu22	20	25	22.1	3456634501	3456634502
Soldering	Carbon steel	Brass	Cu28 / Cu35	66	32	28	3456644001	-
Welding	Carbon steel	Stainless steel	DN20	33	26.9	-	3456632301	-

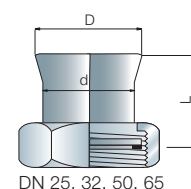

### Coupling ISO G 1¼"

Type	Nut material	Pipe material	Size	L (mm)	D (mm)	d (mm)	Item no. 2 pack	Item no. 50 pack
Welding	Carbon steel	Carbon steel	DN25	50	33.7	-	3456631901	3456631902
Welding	Carbon steel	Carbon steel	DN32	43	42.4	33.7	3456632601	3456632602
Soldering	Carbon steel	Brass	Cu28	50	31.9	28	3456632101	3456632102
Welding	Carbon steel	Stainless steel	DN25	50	33.7	-	3456632001	-
Welding	Carbon steel	Stainless steel	DN32	43	42.4	33.7	3456632901	-

### Coupling ISO G 2"

Type	Nut material	Pipe material	Size	L (mm)	D (mm)	d (mm)	Item no. 2 pack	Item no. 30 pack
Welding	Carbon steel	Carbon steel	DN40	50	48.3	-	3456632501	3456632502
Welding	Carbon steel	Carbon steel	DN50	50	60.3	52	3456631601	3456631602
Soldering	Carbon steel	Brass	Cu42	44	48	42.1	3456634401	-
Soldering	Carbon steel	Brass	Cu54	50	50.9	44.5	3456631801	-
Welding	Carbon steel	Stainless steel	DN40	50	48.3	-	3456631701	-
Welding	Carbon steel	Stainless steel	DN50	50	60.3	52	3456633001	-

### Coupling ISO G 2½"

Type	Nut material	Pipe material	Size	L (mm)	D (mm)	d (mm)	Item no. 2 pack	Item no. 30 pack
Welding	Carbon steel	Carbon steel	DN60	65	76.1	60.3	3456634801	-

Gaskets are included in all above couplings.

### Counter compact flange kit

Bolts and gaskets are included in below counter compact flange kits.

Size	Nut material	Flange material	L (mm)	D (mm)	d (mm)	e	Item no.
DN65	Stainless steel	Stainless steel	33.5	76.1	70.3	13.5	3456325101
DN65	Carbon steel	Stainless steel	33.5	76.1	70.3	13.5	3456325102
DN80	Stainless steel	Stainless steel	33.5	88.9	82.5	13.5	3456325103
DN80	Carbon steel	Stainless steel	33.5	88.9	82.5	13.5	3456325104
DN100	Stainless steel	Stainless steel	33.5	114.3	107.1	13.5	3456325105
DN100	Carbon steel	Stainless steel	33.5	114.3	107.1	13.5	3456325106

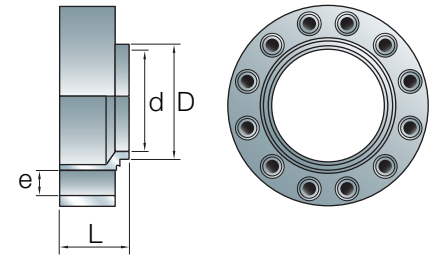

### Extra gasket fitting

Gaskets are included in all above couplings.

Size	Thickness	L (mm)	D (mm)	d (mm)	Item no. 2 pack	Item no. 50 pack
DN15	1.5	1.5	46	24	3456636101	-
DN20	1.5	1.5	30	23	3456636001	3456636002
DN25	1.5	1.5	39	30	3456635901	-
DN40	1.5	1.5	56.5	46	3456639901	3456639902
DN50	1.5	1.5	72	63	3456640001	-
DN65	1.5	1.5	90	70	3456287002	-
DN80	1.5	1.5	106	83	3456287003	-
DN100	1.5	1.5	132	107	3456287004	-

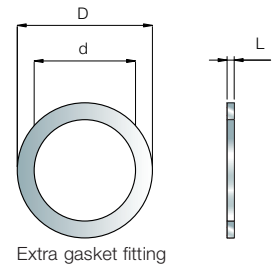

Extra gasket fitting

#### How to contact Alfa Laval

Up-to-date AlfaLaval contact details for all countries are always available on our website on [www.alfalaval.com](http://www.alfalaval.com)



# Feet

## Brazed and Fusion-bonded heat exchangers

Alfa Laval offers a wide range of accessories to our products. This leaflet shows the feet and floor support kits available from stock.

### Floor support kit, height adjustable

Material: Black painted steel

**CB30, CB60, AlfaNova 27** (Fits connections 1¼" and smaller)

Nbr. of plates	L	Item nbr.
10-60	45	3456089801
61-100	130	3456089802
101-150	200	3456089803

**CB76, CB110, CB112, AlfaNova 76** (Fits connections 2½" and smaller)

Nbr. of plates	L	Item nbr.
10-60	190	3456090801
61-90	260	3456090804
91-120	350	3456090802
121-150	350	3456090803

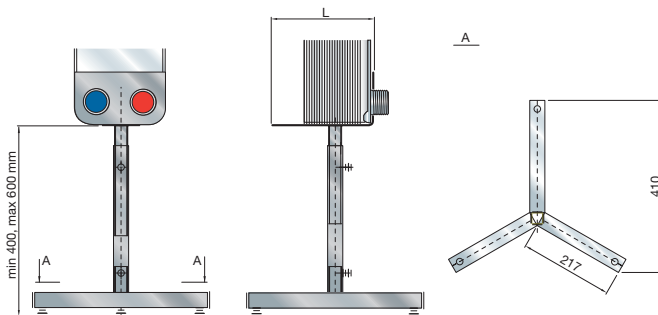

### Floor support kit

Material: Galvanized steel

**CB30, CB60, AlfaNova 27** (Fits connections 1" and smaller)

Nbr. of plates	L	Item nbr.
Max. 30 plates	55	162965401
Max. 150 plates	110	162965402

**CB76, CB110, CB112, AlfaNova 76**

Nbr. of plates	L	Item nbr.
Max. 30 plates	190	162965501
Max. 150 plates	190	162965502

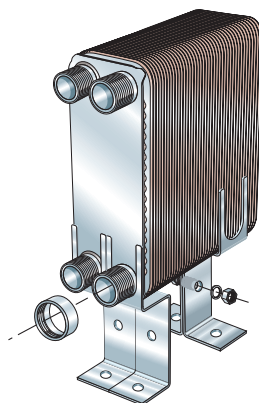

### Rigid feet

Require studbolts welded on the heat exchanger.

Material: Galvanized steel

Model	X	Y	Z	Item nbr.
CB76, AlfaNova 76				
CB110, CB112, AC112	199	269	A + 180	3456544501
CB200	178	400	A + 160	Incl. in the heat exchanger
CB300	217 (S2) / 194.5 (S3)	466	A + 260	Incl. in the heat exchanger
CB400, AlfaNova 400	242	466	A + 260	Incl. in the heat exchanger

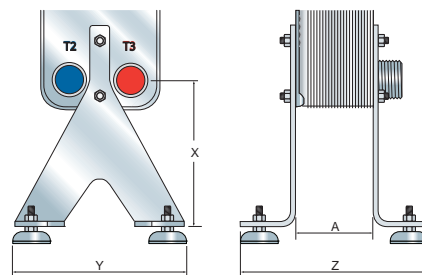

**How to contact Alfa Laval**

Up-to-date AlfaLaval contact details for all countries are always available on our website on [www.alfalaval.com](http://www.alfalaval.com)



## Heating insulation

### Brazed and Fusion-bonded plate heat exchangers

The Alfa Laval heating insulations for brazed and fusion bonded plate heat exchangers are easily assembled and dismantled. The heating insulation provides protection from the heat pack and keeps the climate in the operating room dry and not too hot.

For the smaller sizes, up to CB100, the insulations can only be ordered as extras. For the larger sizes, the insulations are customized and assembled at the factory and are therefore ordered as a part of the heat exchanger.

There are different types of heating insulations to fit each demand:

#### Type A Heating

- Blue plastic cover with CFC-free polyurethane foam
- Thickness 30 mm
- Thermal conductivity: 0.031 w/mK
- Max. temperature: 140°C
- Fire class rating: Class F, DIN 4102 B3

#### Type B Heating

- Black EPP - polypropylen (no cover)
- Thickness 20 mm
- Thermal conductivity: 0.039 w/mK
- Max. temperature: 110 °C

#### Type W Heating

- Insulation: 65 mm mineral wool covered with 0.05 mm alu foil on the inside
- Cladding sheet: 1 mm Alustucco
- Lock: Galvanized steel
- Thermal conductivity: 0.024 w/mK
- Max. temperature: 200°C
- Fire class rating: A1 acc. To RD 19/12/1997
- Class 1 according to BS 476 Part 7
- Class 1 according to FM approval Standard 4450
- Euroclass D according to EN 13501-1





### Type A Heating

Model	c	d	a	b	L
AC18/CB18/CB20	384	157	270	46	*)
CB30/AlfaNova 27	360	182	250	50	*)
CB60/AlfaNova 52	588	182	466	50	*)
CB110/CB112/AlfaNova 76	670	240	520	92	*)
CB100	555	315	378	138	*)
CB200	832	370	522	205	*)
CB300	1094	470	**)	213.5	*)
CB400/AlfaNova 400	1055	520	825	225	*)
AlfaNova 400					

\*) Sizes to fit all standard sizes

\*\*) Side S1, S2 = 816 mm. Side S3, S4 = 861 mm.

### Type B Heating

Model	c	d	a	b	L
CB14/CB16/AlfaNova 14	248	120	172	42	*)
CB18/CB20	366	137	272	46	*)
CB30/AlfaNova 27	354	156	250	50	*)
CB60/AlfaNova 52	570	156	466	50	*)

\*) Sizes to fit all standard item sizes

### Type W Heating

Model	c	d	a	b	L
CB400/AlfaNova 400	1055	570	825	255	*)

\*) Sizes to fit all standard item sizes

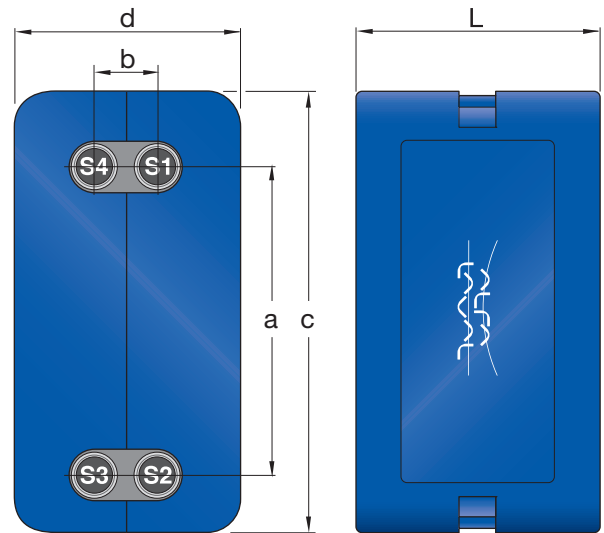

#### How to contact Alfa Laval

Up-to-date AlfaLaval contact details for all countries are always available on our website on [www.alfalaval.com](http://www.alfalaval.com)



## Cooling Insulation Type P

### Brazed and Fusion Bonded plate heat exchanger

Alfa Laval offers a wide range of accessories to our products. This leaflet describes the Type P cooling insulation. Type P is a flexible cooling insulation in soft material which is easy to install and adjust to your specific heat exchanger.

#### Description

Prefabricated insulation jacket with 19 mm thickness closed cell expanded elastomer and with 0.5 mm external PVC protection layer.

The diffusion tight insulation is intended for Alfa Laval brazed and fusion bonded plate heat exchangers and is suitable for cooling and low temperatures.

Max temperature: 100°C

Min temperature: -45°C

The insulation kit is composed by three parts: one lateral and two back and front pieces together with an installation manual.

#### Advantages

- Easy to install
- Can be mounted also after the connections have been mounted, thanks to the pre-cut S3 and S4 holes
- Available from stock
- Suitable for 6 connections thanks to the pre-cut T1 and T2 holes



Properties	Reference values	Reference regulation
<b>Density</b>		
	• 60 kg/m <sup>3</sup>	DIN 53420
<b>Working temperatures</b>		
Max. temperature	+100°C	
Min. temperature	-45°C	
<b>Thermal conductivity <math>\lambda</math></b>		
-40°C	0.028 W/(m•K)	DIN 56613
-20°C	0.030 W/(m•K)	DIN 56613
0°C	0.033 W/(m•K)	DIN 56613
+20°C	0.036 W/(m•K)	DIN 56613
+50°C	0.040 W/(m•K)	DIN 56613
<b>Permeability</b>		
Resistance to the steam diffusion $\mu$	> 7000	DIN 52616
<b>Fire resistance</b>		
Italy	Class 1	UNI 9174 - UNI 8457
France	Class M1	AFNOR NF P92 501
Sweden	Klass II	NTF 036
Norway	Klass II	NTF 036
Finland	Klass II	NTF 036
Finland	Klass 1	NTF002
Switzerland	BKZ	-
<b>Ozone resistance</b>		
	Excellent	UNI 4905
<b>Dimensional stability</b>		
	0.3 - 0.5% shrinkage	

### Complete insulation Type P set

An installation manual is also included in the set.

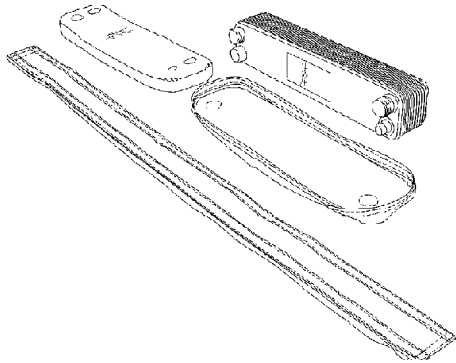

### Easy to install

It is not needed to use special tools.

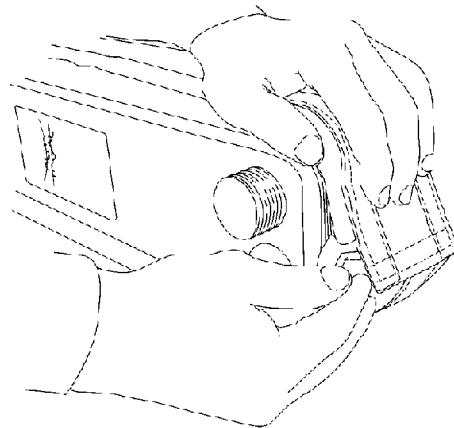

### How to contact Alfa Laval

Up-to-date AlfaLaval contact details for all countries are always available on our website on [www.alfalaval.com](http://www.alfalaval.com)



## Alfa Laval CIP 20 and Alfa Laval CIP 40

### Cleaning in place unit for heat exchangers

A problem frequently encountered in almost all applications is the build-up of deposits on heat transfer surfaces. Alfa Laval supplies a wide range of cleaning agents suitable for removing most of these troublesome deposits and restoring performance to optimal levels. The time-consuming work of opening plate heat exchangers can thus often be avoided by using an Alfa Laval Cleaning in Place (CIP) unit.

Alfa Laval CIP units are available in a wide range of standard sizes, with optional extras that include reversible flow and explosion-proof capabilities. Alfa Laval CIP units can be used for all types of heat exchangers, including spiral heat exchangers, shell-and-tube heat exchangers and gasketed, welded and brazed plate heat exchangers.

#### Concept

Alfa Laval CIP units are simplicity itself:

- Connect the Alfa Laval CIP unit to the heat exchanger
- Mix the cleaning agent with water in the tank
- Circulate the cleaning solution a couple of hours
- Drain and rinse
- Disconnect the CIP unit
- The heat exchanger is back to full performance capacity



Alfa CIP 40



Alfa CIP 20

Alfa Laval CIP units are a cost-effective way to achieve better performance, and the cleaning agents used are, of course, environmentally friendly.

In addition to boosting the performance of all kinds of heat exchangers, Alfa Laval cleaning agents extend the operating time between cleaning cycles as well as prolonging the overall lifetime of the heat exchangers, without damaging the plates or gaskets.

#### Features & benefits

- Connected directly to inlet and outlet. This avoids any need to open the heat exchanger, which in turn minimizes downtime and prolongs the working life of the gasket.
- High-quality equipment that is CE marked.
- Valves for reversible flow direction. This makes it possible to remove the solid particles rapidly, and is easy to operate without needing to rearrange the connection hoses.

## Technical specifications

	Alfa Laval CIP 20	Alfa Laval CIP 40/50 Hz	Alfa Laval CIP 40/60 Hz
Pump	Centrifugal	Centrifugal	Centrifugal
Max. flow rate	2.1 m <sup>3</sup> /h (8.7 gpm)	2.4 m <sup>3</sup> /h (10.6 gpm)	2.1 m <sup>3</sup> /h (8.7 gpm)
At pumping head	8 m	15 m	15 m
Motor power	170 W	400 W	400 W
Voltage	230 V/1 phase/50 Hz	230 V/1 phase/50 Hz	110 V/1 phase/60 Hz
Max. operating temp	60°C (140°F)	60°C (140°F)	60°C (140°F)
Volume	20 litres (5.3 US gallons)	40 litres (10.6 US gallons)	40 litres (10.6 US gallons)
Weight	8 kg	15 kg	15 kg
Length	500 mm	730 mm	730 mm
Width	250 mm	320 mm	320 mm
Height	350 mm	530 mm	530 mm
Number of hoses	2	2	2
Hose length	2.6 m	2.6 m	2.6 m
Hose material	PVC reinforced	PVC reinforced	PVC reinforced
Connection	ISO 228 ¾"	ISO 228 ¾"	ISO 228 ¾"
Pump wetted parts	PP (Polypropylene)	PP (Polypropylene)	PP (Polypropylene)
Pump gaskets	NBR	NBR	NBR
Hose connection gaskets	EPDM	EPDM	EPDM
Material for wetted parts	PE (Polyethylene)	PE (Polyethylene)	PE (Polyethylene)
Protection class	IP54	IP54	IP54
Eexd (explosion-proof)	No	No	No
Art. no.	32840005-01	32840000-01	32840436-01

### How to contact Alfa Laval

Up-to-date AlfaLaval contact details for all countries are always available on our website on [www.alfalaval.com](http://www.alfalaval.com)





## Alfa Laval CIP 200L and CIP 400L

Stainless steel cleaning in place units for heat exchangers



A problem frequently encountered in almost all applications is the build-up of deposits on heat transfer surfaces. Alfa Laval supplies a wide range of cleaning agents suitable for removing most of these troublesome deposits and restoring performance to optimal levels. The time-consuming work of opening plate heat exchangers can thus often be avoided by using an Alfa Laval Cleaning in Place (CIP) unit. These are available in a wide range of standard sizes that include reversible flow capability. Alfa Laval CIP units can be used for all types of heat exchangers, including spiral heat exchangers, shell-and-tube heat exchangers and gasketed welded and brazed plate heat exchangers.

### Concept

Alfa Laval CIP units are simplicity itself:

- Connect the Alfa Laval CIP unit to the heat exchanger
- Mix the cleaning agent with water in the tank and heat it up
- Circulate the cleaning solution a few of hours
- Drain and rinse
- Disconnect the CIP unit
- The heat exchanger is back to full performance capacity

Alfa Laval CIP units are a cost-effective way to achieve better performance, and the cleaning agents used are, of course, environmentally friendly.

In addition to boosting the performance of all kinds of heat exchangers, Alfa Laval cleaning agents extend the operating time between cleaning cycles as well as prolonging the overall lifetime of the heat exchangers, without damaging the plates or gaskets.

### Features and benefits

- Connected directly to inlet and outlet. This avoids any need to open the heat exchanger, which in turn minimizes downtime and prolongs the working life of the gasket.
- Wetted parts in the operating unit, as well as the pump and valves, are made of AISI 304 or AISI 316 stainless steel to ensure maximum working life.
- Rapid cleaning at optimal temperatures, due to built-in electric heater.
- Valve arrangement for reversible flow direction. This makes it possible to remove the solid particles rapidly, and is easy to operate without the need to rearrange the connection hoses.

## Technical specifications

	Alfa Laval CIP 200L	Alfa Laval CIP 400L
Circulation pump	Centrifugal stainless steel	Centrifugal stainless steel
Pump capacity max. at 3.2 bar head	10 m <sup>3</sup> /h	10 m <sup>3</sup> /h
Voltage	380–440V/3-phase/50 Hz	380–420V/3-phase/50 Hz
	440–480V/3-phase/60 Hz	440–480V/3-phase/60 Hz
Pump motor size (50/60Hz)	2.3/4.2 kW	2.3/4.2 kW
Total heating power	6 alt. 12 kW	12 kW
Max. operating temp	85°C	85°C
	(185°F)	(185°F)
Volume	200 litres	400 litres
	(53 US gallons)	(106 US gallons)
Modules	1 pump + 1 tank	1 pump + 2 tanks
Weight empty module, pump + tank(s)	55+90 kg = 145 kg	55+90+90 kg = 235 kg
Size pump module (H x W x L)	1345 x 475 x 775 mm	1345 x 475 x 775 mm
Size per each tank module (H x W x L)	1345 x 475 x 1035 mm	1345 x 475 x 1035 mm
Number of hoses	4	6
Hose length	4 m	4 m
Hose material inside/outside	UPE/EPDM	UPE/EPDM
Connection standard	DIN 11851/DN 40	DIN 11851/DN 40
Material for wetted parts	Stainless steel AISI 304/316	Stainless steel AISI 304/316
Pump gaskets	EPDM	EPDM
Pump seal	C/SiC	C/SiC
Hose connection gaskets	EPDM	EPDM
Eexd (explosion-proof)	On request	On request

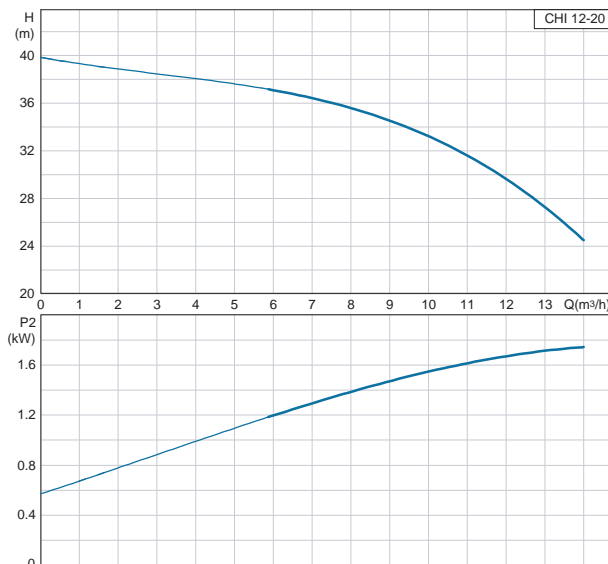

Pump graph (50 Hz).

## Optionals

Item no

- 96994900-03 Welding piece for CIP connection to PHE pipe <DN40
- 96994900-04 Welding piece for CIP connection to PHE pipe >=DN40
- 96995110-14 Spanner DN40
- 96995110-16 Adapter DN40/BSP 1 1/2"
- 96995110-17 Isolation valve at PHE pipe connection DN40 butterfly valve AISI 304
- 96995110-18 Manometer 0–10 bar
- 96995110-19 Thermometer 0–200°C
- 96995110-20 96995110-20 Hose DN40, 6 m

PPS00065EN 1202

Alfa Laval reserves the right to change specifications without prior notification.

## How to contact Alfa Laval

Up-to-date AlfaLaval contact details for all countries are always available on our website on [www.alfalaval.com](http://www.alfalaval.com)



## Alfa Laval CIP 800L

Stainless steel cleaning in place unit for heat exchangers



A problem frequently encountered in almost all applications is the build-up of deposits on heat transfer surfaces. Alfa Laval supplies a wide range of cleaning agents suitable for removing most of these troublesome deposits and restoring performance to optimal levels. The time-consuming work of opening plate heat exchangers can thus often be avoided by using an Alfa Laval Cleaning in Place (CIP) unit. These are available in a wide range of standard sizes that include reversible flow capability. Alfa Laval CIP units can be used for all types of heat exchangers, including spiral heat exchangers, shell-and-tube heat exchangers and gasketed, welded and brazed plate heat exchangers.

### Concept

Alfa Laval CIP units are simplicity itself:

- Connect the Alfa Laval CIP unit to the heat exchanger
- Mix the cleaning agent with water in the tank and heat it up
- Circulate the cleaning solution a couple of hours
- Drain and rinse
- Disconnect the CIP unit
- The heat exchanger is back to full performance capacity

Alfa Laval CIP units are a cost-effective way to achieve better performance, and the cleaning agents used are, of course, environmentally friendly.

In addition to boosting the performance of all kinds of heat exchangers, Alfa Laval cleaning agents extend the operating time between cleaning cycles as well as prolonging the overall lifetime of the heat exchangers, without damaging the plates or gaskets.

### Features and benefits

- Connected directly to inlet and outlet. This avoids any need to open the heat exchanger, which in turn minimizes downtime and prolongs the working life of the gasket.
- Wetted parts in the operating unit, as well as the pump and valves, are made of AISI 316 stainless steel to ensure maximum working life.
- Rapid cleaning at optimal temperatures, due to built-in electric heaters.
- Valve arrangement for reversible flow direction. This makes it possible to remove the solid particles rapidly, and is easy to operate without needing to rearrange the connection hoses.

## Technical specifications

<b>Alfa Laval CIP 800</b>	
Circulation pump	Centrifugal sanitary
Pump capacity max. at 3.2 bar head	40 m <sup>3</sup> /h
Voltage	380–420V/3-phase/50 Hz 440–480V/3-phase/60 Hz
Pump motor size (50/60Hz)	7.5/8.6 kW
Total heating power	12 kW alt. 24 kW
Heating time in tank, approx.	12 kW/4 h alt. 24 kW/2 h
Max. operating temperature	85°C (185°F)
Volume	800 litres (212 US gallons)
Weight empty module	300 kg
Size module (H x W x L)	1735 x 2160 x 1260 mm
Number of hoses	2
Hose length	4 m
Hose material inside/outside	UPE/EPDM
Connection standard	DIN 11851/DN 65
Material for wetted parts	Stainless steel AISI 304/316
Pump gaskets	EPDM
Pump seal	C/SIC
Hose connection gaskets	EPDM
Eexd (explosion-proof)	On request

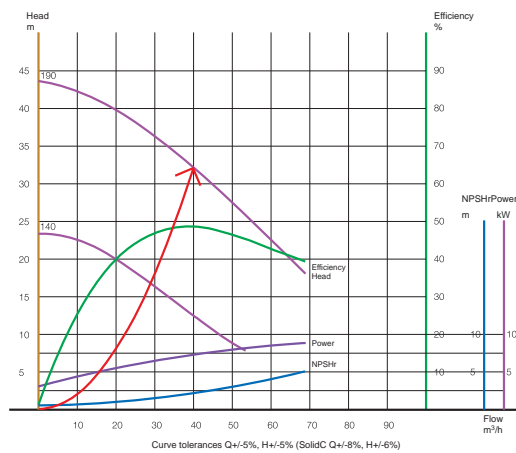

Pump graph (50 Hz).

## Optionals

Item no

- 96994900-05 Welding piece for CIP connection to PHE pipe  $\geq$ DN65
- 96995310-14 Spanner DN 65 DIN union
- 96995310-16 Adapter DN 65/BSP 21/2"
- 96995310-17 Isolation valve at PHE pipe connection DN65 butterfly valve AISI 304
- 96995310-18 Manometer 0-10 bar
- 96995310-19 Thermometer 0-200°C
- 96995310-20 Hose DN65, 6 m

PPS 00066EN 1202

Alfa Laval reserves the right to change specifications without prior notification.

### How to contact Alfa Laval

Up-to-date AlfaLaval contact details for all countries are always available on our website on [www.alfalaval.com](http://www.alfalaval.com)



## Alfa Laval CIP 1800L and CIP 2800L

Stainless steel cleaning in place units for heat exchangers



A problem frequently encountered in almost all applications is the build-up of deposits on heat transfer surfaces. Alfa Laval supplies a wide range of cleaning agents suitable for removing most of these troublesome deposits and restoring performance to optimal levels. The time-consuming work of opening plate heat exchangers can thus often be avoided by using an Alfa Laval Cleaning in Place (CIP) unit. These are available in a wide range of standard sizes that include reversible flow capability. Alfa Laval CIP units can be used for all types of heat exchangers, including spiral heat exchangers, shell-and-tube heat exchangers and gasketed, welded and brazed plate heat exchangers.

### Concept

Alfa Laval CIP units are simplicity itself:

- Connect the Alfa Laval CIP unit to the heat exchanger
- Mix the cleaning agent with water in the tank and heat it up
- Circulate the cleaning solution a couple of hours
- Drain and rinse
- Disconnect the CIP unit
- The heat exchanger is back to full performance capacity

Alfa Laval CIP units are a cost-effective way to achieve better performance, and the cleaning agents used are, of course, environmentally friendly.

In addition to boosting the performance of all kinds of heat exchangers, Alfa Laval cleaning agents extend the operating time between cleaning cycles as well as prolonging the overall lifetime of the heat exchangers, without damaging the plates or gaskets.

### Features and benefits

- Connected directly to inlet and outlet. This avoids any need to open the heat exchanger, which in turn minimizes downtime and prolongs the working life of the gasket.
- Wetted parts in the operating unit, as well as the pump and valves, are made of AISI 304 or AISI 316 stainless steel to ensure maximum working life.
- Rapid cleaning at optimal temperatures, due to built-in electric heaters.
- Valve arrangement for reversible flow direction. This makes it possible to remove the solid particles rapidly, and is easy to operate without the need to rearrange the connection hoses.



## Technical specifications

	Alfa Laval CIP 1800L	Alfa Laval CIP 2800L
Circulation pump	Centrifugal sanitary	Centrifugal sanitary
Voltage	380–420 V/3-phase/50 Hz 440–480 V/3-phase/60 Hz	380–420 V/3-phase/50 Hz 440–480 V/3-phase/60 Hz
Pump motor size (50/60 Hz)	7.5/8.6 kW	7.5/8.6 kW
Total heating power	24 kW alt. 48 kW	48 kW
Heating time in tank, approx.	24 kW/4 h alt. 48 kW/2 h	48 kW/3.5 h
Max. operating temp	85°C (185°F)	85°C (185°F)
Volume	1800 litres (477 US gallons)	2800 liters (742 US gallons)
Modules	1 pump/tank + 1 tank	1 pump/tank + 2 tanks
Weight empty module, pump + tank(s)	300+150 kg = 450 kg	300+150+150 kg = 600 kg
Size module incl. tank (H x W x L)	1735 x 2160 x 1260 mm	1735 x 2160 x 1260 mm
Size per each additional tank module (H x W x L)	1483 x 960 x 960 mm	1483 x 960 x 960 mm
Number of hoses	4	6
Hose length	4 m	4 m
Hose material inside/outside	UPE/EPDM	UPE/EPDM
Connection standard	DIN 11851/DN 65	DIN 11851/DN 65
Material for wetted parts	Stainless steel AISI 304/316	Stainless steel AISI 304/316
Pump gaskets	EPDM	EPDM
Pump seal	C/SiC	C/SiC
Hose connection gaskets	EPDM	EPDM
Eexd (explosion-proof)	On request	On request

\* See pump curve for flow rate and pumping head

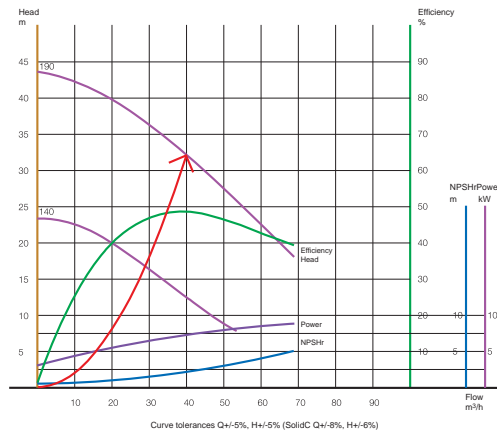

Pump graph (50 Hz).

### Optionals

Item no

96994900-05

Welding piece for CIP connection to PHE pipe  $\geq$ DN65

96995310-14

Spanner DN 65 DIN union

96995310-16

Adapter DN 65/BSP 21/2"

96995310-17

Isolation valve at PHE pipe connection DN65 butterfly valve AISI 304

96995310-18

Manometer 0–10 bar

96995310-19

Thermometer 0–200°C

96995310-20

Hose DN65, 6 m

PPS00064EN 1202

Alfa Laval reserves the right to change specifications without prior notification.

### How to contact Alfa Laval

Up-to-date AlfaLaval contact details for all countries are always available on our website on [www.alfalaval.com](http://www.alfalaval.com)



# Chapter 8

1. The Alfa Laval Group
2. Heating and cooling solutions from Alfa Laval
3. Applications
4. The theory behind heat transfer
5. Product range
6. Gasketed plate heat exchangers
7. Brazed plate heat exchangers
- 8. Fusion-bonded plate heat exchangers, AlfaNova**
9. Air heat exchangers
10. All-welded heat exchangers
11. Filters



# Fusion-bonded plate heat exchangers, AlfaNova

From the extreme heat in our furnaces comes AlfaNova, the world's first 100% stainless-steel plate heat exchanger.

The AlfaNova can handle high temperatures and has good resistance to pressure fatigue compared to a conventional brazed plate heat exchanger.

The secret is AlfaFusion, a unique bonding technology patented by Alfa Laval. Resulting in the world's first fusion-bonded plate heat exchanger, AlfaFusion has stunned specialists in the brazing field.

AlfaNova is a new class of plate heat exchangers, available only from Alfa Laval.







## AlfaNova takes heat-transfer technology to the extreme

100%  
stainless  
steel



AlfaNova consists of a number of corrugated stainless steel plates, a frame plate, a pressure plate and connections – all in stainless steel of type 316. All components are bonded together by AlfaFusion, a new technology patented by Alfa Laval.

The result is the fusion-bonded plate heat exchanger, a whole new class offering extremely high mechanical strength.

It is also hygienic, corrosion-resistant and fully recyclable.

### **Unbeatable reliability**

Years of research and testing have confirmed AlfaNova's high mechanical strength and unbeatable reliability.

The AlfaFusion technology creates a plate heat exchanger with possibilities to go much higher in temperature than conventional brazed units.

Its 100% stainless-steel design allows AlfaNova to withstand temperatures of up to 550°C (1,020°F).

### **Corrosion-resistant**

The AlfaNova's pure stainless-steel design also ensures high resistance to corrosion.

Thus, it represents a major breakthrough for refrigeration system builders using natural refrigerants such as ammonia.

It is also the perfect choice for district heating installations in areas with corrosive water or applications utilizing corrosive liquids.

### **Maximum purity**

Purity is the subject of increasingly stringent legislation in many countries.

Applications affected are clean-water chillers in refrigeration systems, tap water heating systems, and a long list of other hygienic areas.

For these applications, the 100% stainless-steel AlfaNova, with its clean, hygienic heat-transfer channels and high mechanical strength, will be the heat exchanger of the future, challenging other types of heat exchangers.

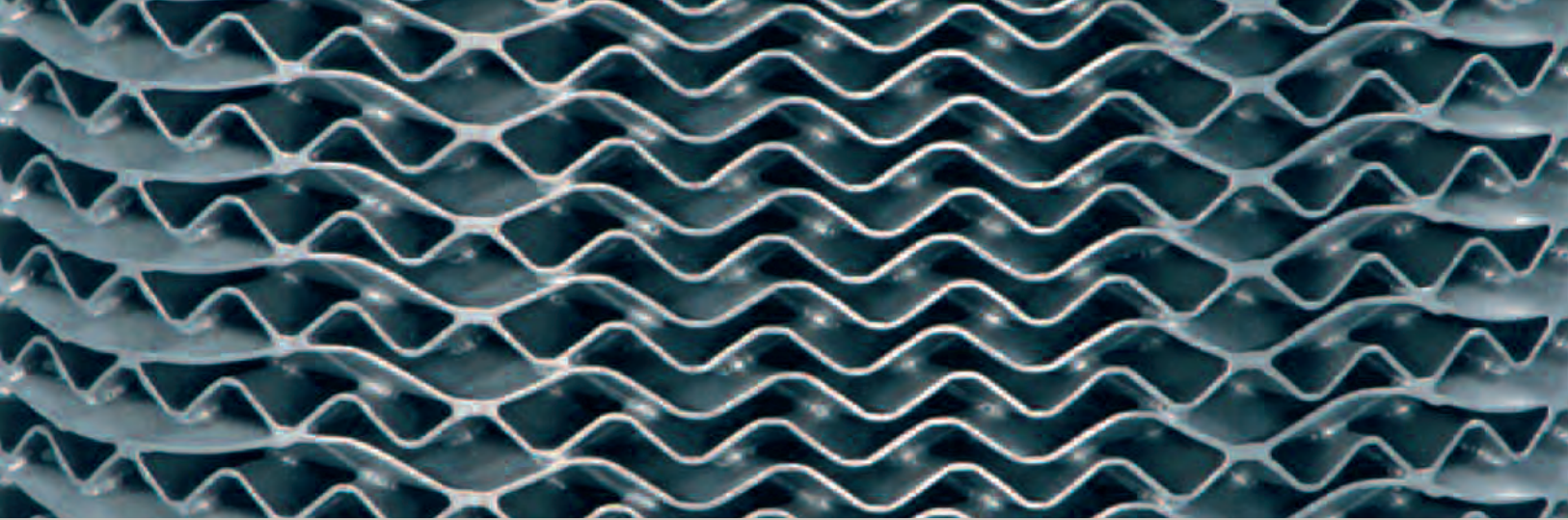

Three different technologies...

## AlfaFusion

Patented by Alfa Laval, AlfaFusion™ is a peak-performance, one-material process that results in an all-stainless steel, fusion-bonded plate heat exchanger.

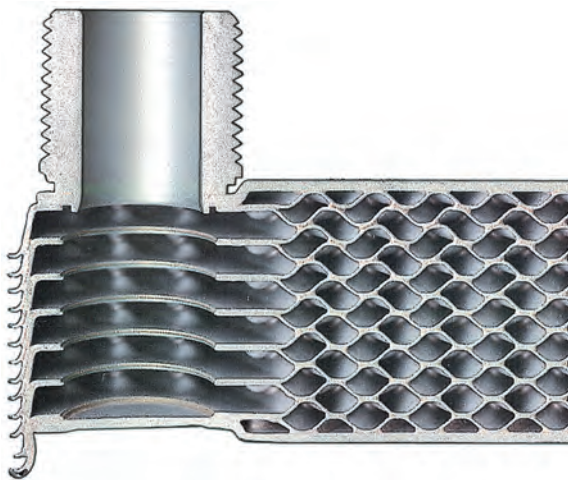

The result is closer to welding than brazing. It is based on Alfa Laval's new, revolutionary technology, AlfaFusion, the art of joining stainless-steel components together. The two stainless-steel components melt in the contact points between the corrugated plates, and a fusion zone is created.

This zone is also stainless steel and has properties similar to the plates in terms of corrosion resistance and durability. Success lies in precise temperature control to achieve the correct melting depth and to avoid melting through the plates.

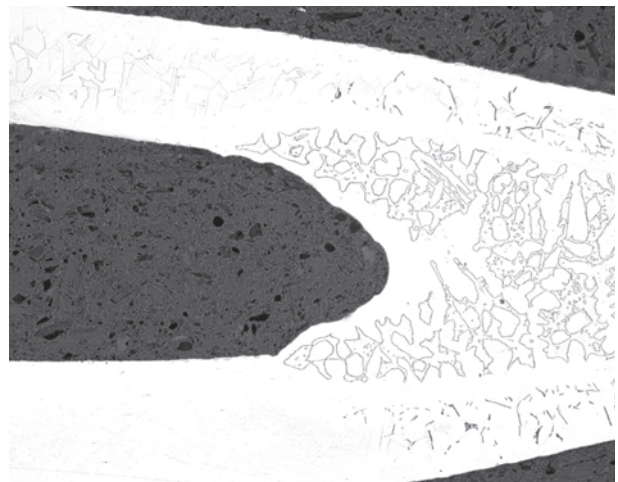

Due to the properties of the fusion zone, AlfaFusion gives a homogenous plate heat exchanger with a high level of corrosion resistance and higher resistance to mechanical and thermal fatigue than other technologies.



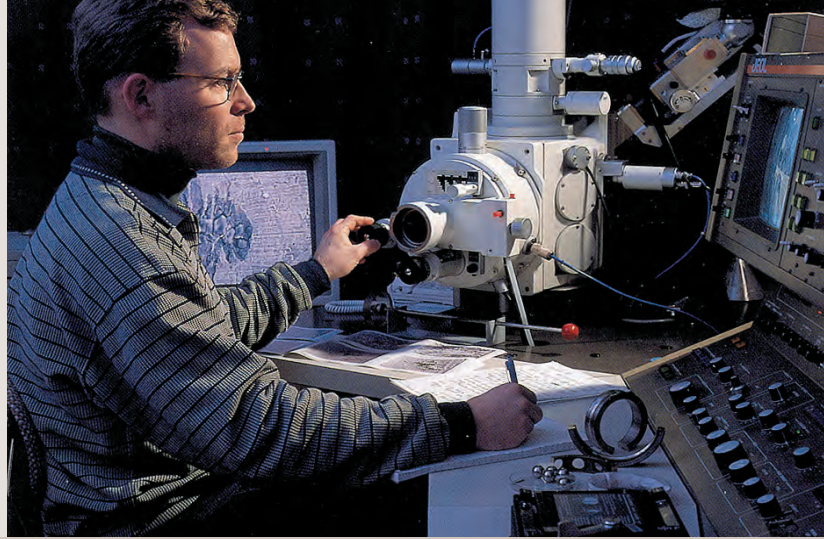

## Traditional copper brazing

A two-material process, copper brazing is an efficient, cost-effective method of manufacturing plate heat exchangers.

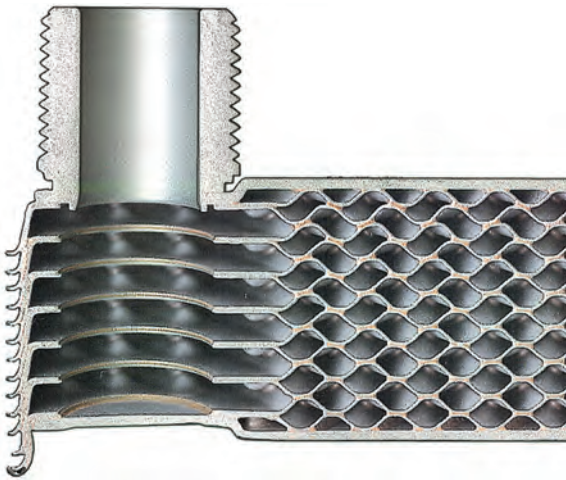

It involves using copper filler to join stainless steel plates together by brazing them in a furnace. At the contact points between the corrugated plates, a thin layer of copper is melted at high temperature. Since copper has good capillary action, i.e., good capability to wet the plate and fill crevices, the filler gathers where the plates have contact, thus sealing and strengthening the plate pack. Although copper brazing causes adhesion between the copper and the stainless steel, there is no surface reaction between the materials.

The combination of stainless steel and copper offers good ductility.

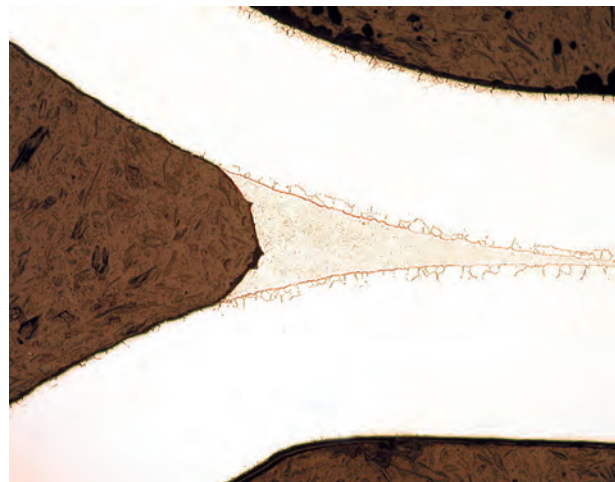

Under pressure, substantial material deformation can occur before splitting occurs. The build-up of stress in the material causes it to change direction, thus relieving the mechanical load. While copper brazing results in a high-quality plate heat exchanger, the brazing process must be carefully controlled, as copper may otherwise penetrate the stainless steel. This results in liquid metal embrittlement, a known metallurgical phenomenon which reduces the strength of the heat exchanger.



## Laser welding

Laser welding is an effective method of joining stainless steel plates together in the manufacture of plate heat exchangers.

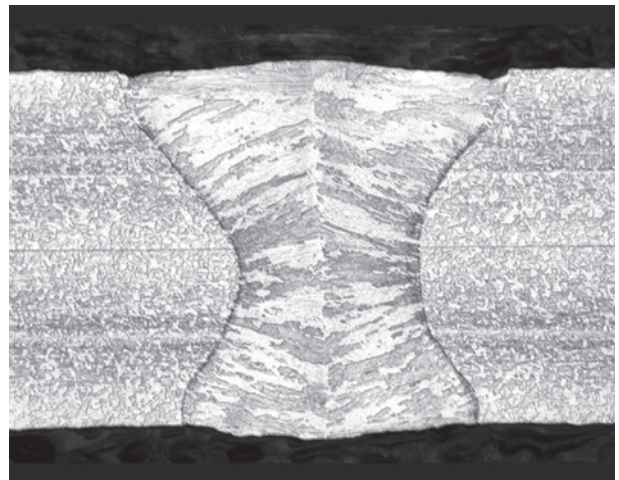
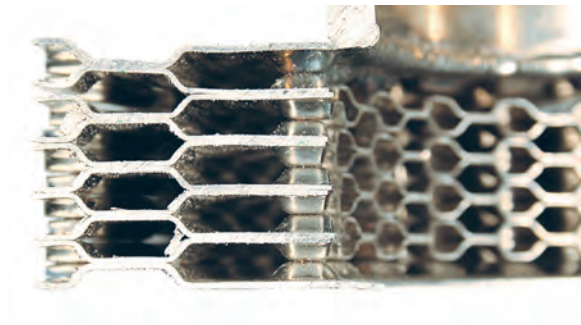

During the process, the corrugated stainless-steel plates are placed against each other and a laser is used to melt the material at the points of contact. As the stainless steel hardens there is diffusion of the metal on the plate surfaces. Since the stainless steel has gained a different micro-structure orientation during hardening, the resulting joints may be different in appearance. However, they possess the same properties as the rest of the plate material in terms of ductility and corrosion resistance.

A fully welded heat exchanger has good mechanical properties and can comfortably withstand high temperature, high pressure and aggressive media. A disadvantage is that it is sometimes necessary to adapt the design of the product to the limitations of the welding technique. It is also an expensive method. The process must take place in an inert atmosphere, otherwise it will react with the oxygen in the air, resulting in less successful welds. The equipment required for the process is also expensive.

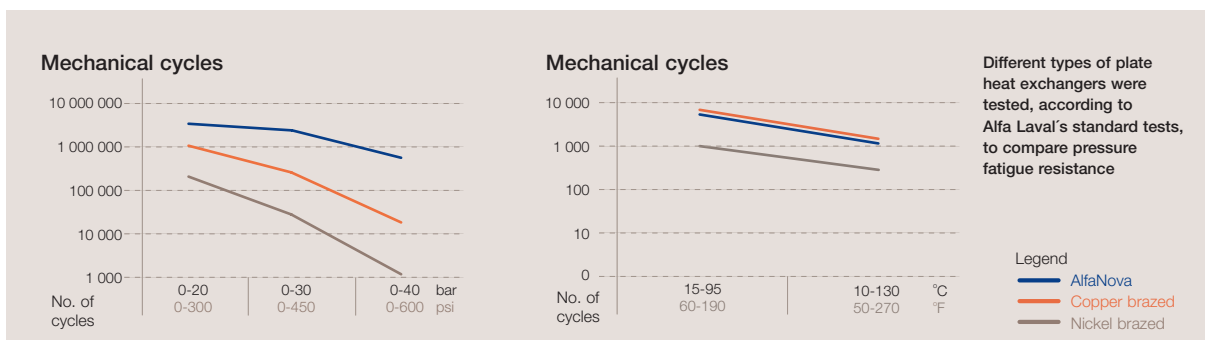





## Applications

### **Rectifier and frequency converter cooling**

The compact fusion-bonded AlfaNova in 100% stainless steel is particularly well suited for pure water when space is limited.

### **Paint temperature control**

The AlfaNova will keep sensitive coatings at the right viscosity in order for perfect adhesion without copper contamination.

### **Compressor cooling**

The AlfaNova has outstanding pressure fatigue resistance and is an excellent product for compressed air cooling when space is limited.

### **Ultrapure water cooling for Semiconductor industry**

Due to the high demands of cleanliness in the Semiconductor manufacturing process the 100% stainless steel AlfaNova is an excellent choice.

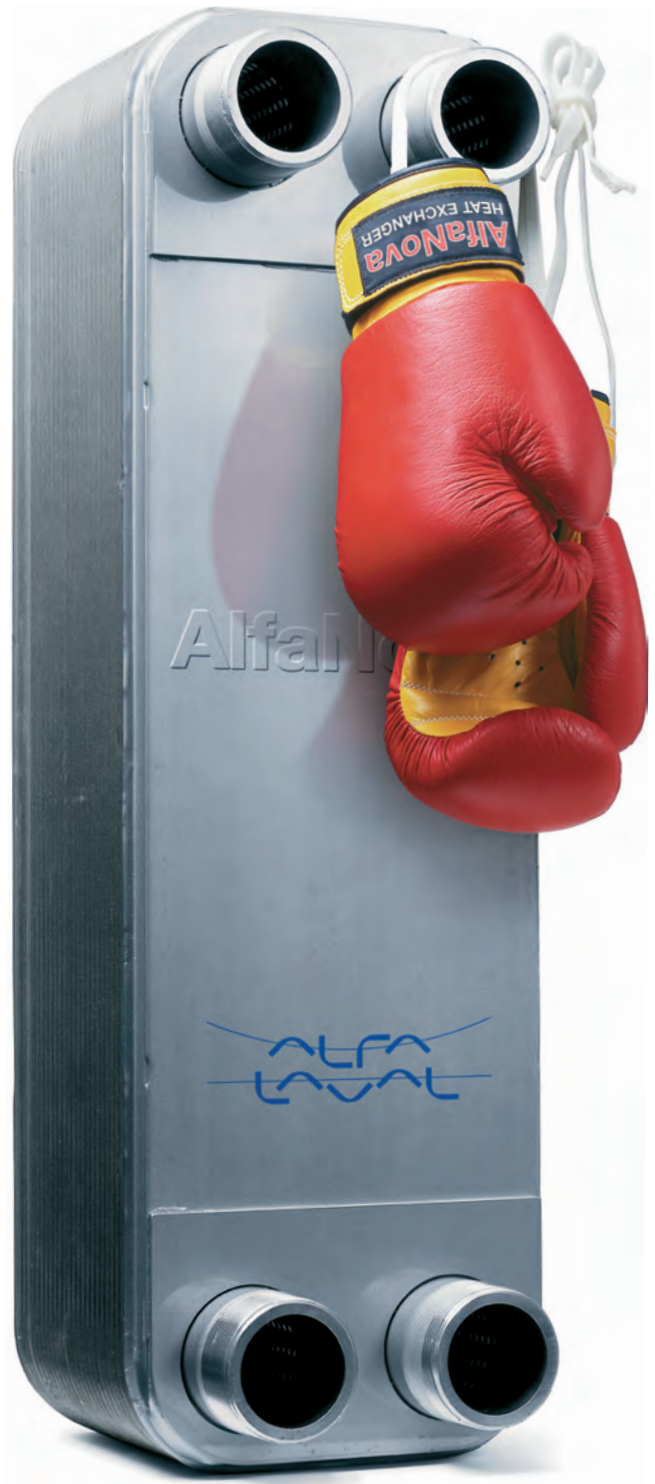





# Technical specifications

## Fusion-bonded plate heat exchangers, data and dimensions

	AlfaNova 14	AlfaNova 27	AlfaNova 52	AlfaNova 76	AlfaNova 400
Channel type	H	H, L	H, L	H, A, E, L	H, L
Max./min. design temperature (°C)	160/-175	160/-175	160/-175	160/-175	160/-175
Max. design pressure S3-S4/S1-S2 (bar) *)	21/21	27/22	27/22	27/22	17/17
Volume/channel (litres)	0.02	0.05	0.095	0.25/0.25	0.74
Max. flowrate (m <sup>3</sup> /h) **)	4.6	14	14	37	200
Height, a (mm)	207	310	526	618	990
Width, b (mm)	77	111	111	191	390
Vertical connection distance, c (mm)	172	250	466	519	825
Horizontal connection distance, d (mm)	42	50	50	92	225
Plate pack length, A (mm)	$n \times 2.48 + 8$	$(n \times 2.42) + 11$	$(n \times 2.48) + 11$	$(n \times 2.85) + 11$ ***	$(n \times 2.65) + 14$
Weight empty (kg)	$(n \times 0.07) + 0.4$	$(n \times 0.13) + 1$	$(n \times 0.22) + 1.9$	$(n \times 0.49) + 8$	$(n \times 1.4) + 22$
Standard connection, external thread (in)	3/4"	1 1/4"/1"	1 1/4"/1"	2"	4"
Plate material	Stainless steel	Stainless steel	Stainless steel	Stainless steel	Stainless steel
Connection material	Stainless steel	Stainless steel	Stainless steel	Stainless steel	Stainless steel
Bounding material	Stainless steel	Stainless steel	Stainless steel	Stainless steel	Stainless steel
Max. number of plates	50	100	150	150	270
Radiator heating, capacity (kW) <sup>2</sup>	90	400	500	1200	3300
Tap water heating, capacity (kW) <sup>2</sup>	60	180	380	700	2700

\*) According to PED \*\*\*) Water at 5 m/s (connection velocity) \*\*\*) H-channel n=number of plates

1) E channel 0.18/0.18; A channel 0.18/0.25

2) Varies from country to country depending on temperature duty. Given values are for typical district heating installations.

3) Valid for H-plate



## AlfaNova plate heat exchangers range

AlfaNova 14	AlfaNova 27	AlfaNova 52	AlfaNova 76
Read all about it on page 8:9	Read all about it on page 8:11	Read all about it on page 8:13	Read all about it on page 8:15
			
AlfaNova 400			
Read all about it on page 8:17			
			





# AlfaNova 14

## Fusion-bonded plate heat exchanger

### General information

AlfaNova is a plate heat exchanger made of 100% stainless steel. It is based on Alfa Laval's revolutionary technology, AlfaFusion, the art of joining stainless steel components together.

AlfaNova heat exchangers are well suited in applications which put high demand on cleanliness, applications where ammonia is used or applications where copper or nickel contamination is not accepted. Its high resistance to corrosion makes it both hygienic and environmental friendly.

It is extremely compact compared to its capacity to withstand great strains in demanding heat transfer applications.

### Applications

Within refrigeration:

- Oil cooling
- Condensing
- Economizing
- Desuperheating
- Absorption systems

Other main applications:

- Domestic hot water
- Process cooling
- Hydraulic oil cooling
- Laser cooling
- Hygienic/sanitary application
- Water/water cooling & heating

### Working principles

The heating surface consists of thin corrugated metal plates stacked on top of each other. Channels are formed between the plates and corner ports are arranged so that the two media flow through alternate channels, always in countercurrent flow. The media are kept in the unit by a bonded seal around the edge of the plates. The contact points of the plates are also bonded to withstand the pressure of the media handled.

### Standard design

The plate pack is covered by cover plates. Connections are located in the front or rear cover plate. The channel plates are corrugated to improve heat transfer design.



### Particulars required for quotation

To enable Alfa Laval's representative to make a specific quotation, enquiries should be accompanied by the following particulars:

- Flow rates or heat load required
- Temperature program
- Physical properties of liquids in question
- Desired working pressure
- Maximum permitted pressure drop

### Examples of connections

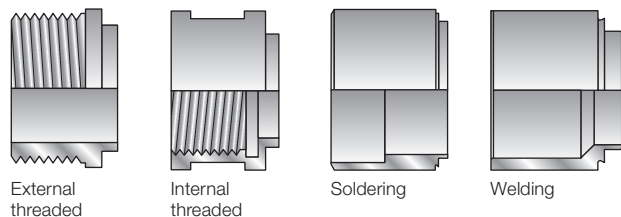

AlfaNova 14 - PED approval pressure/temperature graph

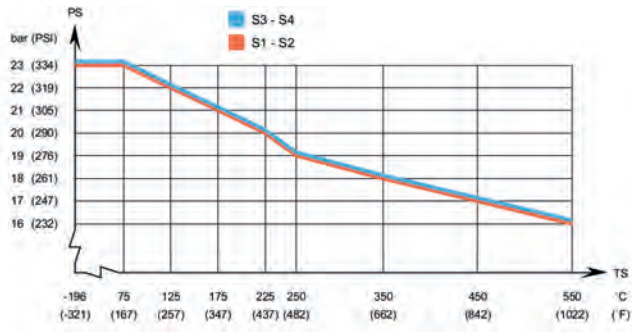

AlfaNova 14 - UL approved pressure/temperature graph

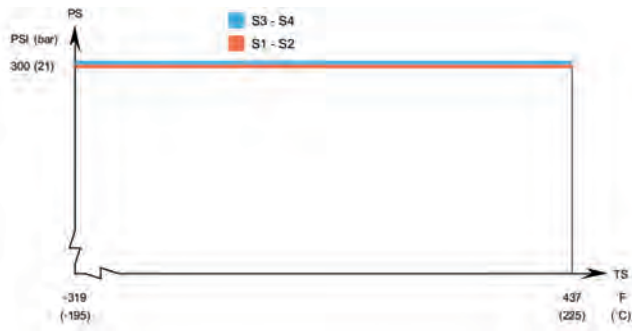

AlfaNova 14 - CRN approved pressure/temperature graph

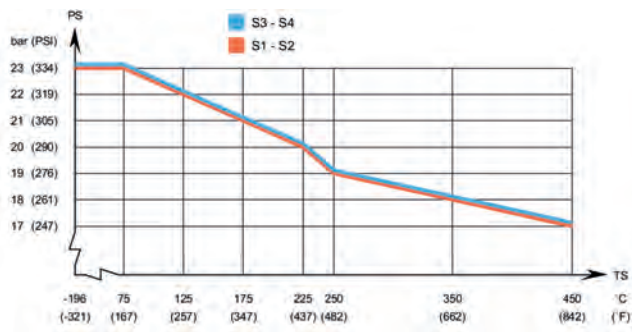

**Standard dimensions**

A measure mm =  $8 + (2.48 * n)$  (+/-3 mm)  
 A measure inch =  $0.31 + (0.1 * n)$  (+/-0.12 inch)  
 Weight kg =  $0.4 + (0.07 * n)$   
 Weight lb =  $0.88 + (0.15 * n)$   
 (n = number of plates)

**Standard data**

Min. working temperature	see graph
Max. working temperature	see graph
Min. working pressure	vacuum
Max. working pressure	see graph
Volume per channel, litres (ga)	0.02 (0.0052)
Max. particle size mm (inch)	1.2 (0.05)
Max. flowrate* m <sup>3</sup> /h (gpm)	4.6 (20.2)
Min. nbr of plates	4
Max. nbr of plates	50

**Standard materials**

Cover plates	Stainless steel
Connections	Stainless steel
Plates	Stainless steel
AlfaFusion filler	Stainless steel

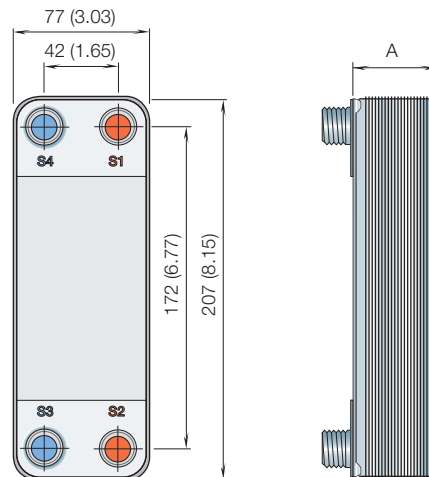

For exact values please contact your local Alfa Laval representatives.

**How to contact Alfa Laval**

Up-to-date AlfaLaval contact details for all countries are always available on our website on [www.alfalaval.com](http://www.alfalaval.com)





# AlfaNova 27

## Fusion-bonded plate heat exchangers

### General information

AlfaNova is a plate heat exchanger made of 100% stainless steel. It is based on Alfa Laval's revolutionary technology, AlfaFusion, the art of joining stainless steel components together.

AlfaNova heat exchangers are well suited in applications which put high demand on cleanliness, applications where ammonia is used or applications where copper or nickel contamination is not accepted. Its high resistance to corrosion makes it both hygienic and environmental friendly.

It is extremely compact compared to its capacity to withstand great strains in demanding heat transfer applications.

### Applications

Within refrigeration:

- Oil cooling
- Condensing
- Evaporating
- Economizing
- Desuperheating
- Absorption systems

Other main applications:

- Domestic hot water heating
- Process cooling
- Hydraulic oil cooling
- Laser cooling
- Hygienic/sanitary application
- Water/water cooling & heating

### Working principles

The heating surface consists of thin corrugated metal plates stacked on top of each other. Channels are formed between the plates and corner ports are arranged so that the two media flow through alternate channels, always in countercurrent flow. The media are kept in the unit by a bonded seal around the edge of the plates. The contact points of the plates are also bonded to withstand the pressure of the media handled.

### Standard design

The plate pack is covered by cover plates. Connections are located in the front or rear cover plate. The channel plates are corrugated to improve heat transfer design.



### Particulars required for quotation

To enable Alfa Laval's representative to make a specific quotation, enquiries should be accompanied by the following particulars:

- Flow rates or heat load required
- Temperature program
- Physical properties of liquids in question
- Desired working pressure
- Maximum permitted pressure drop

### Examples of connections

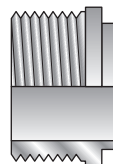

External threaded

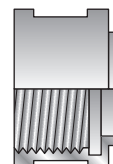

Internal threaded

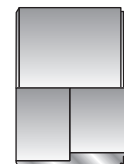

Soldering

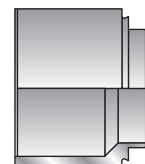

Welding

AlfaNova 27 – PED approval pressure/temperature graph <sup>1)</sup>

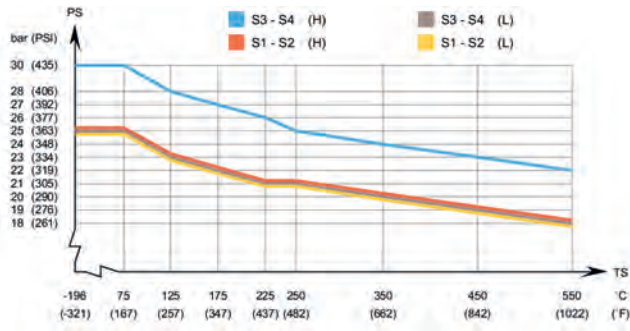

<sup>1)</sup> Min. temperature -10°C (14°F) with connection tube made of carbon steel.

AlfaNova 27 – ASME approval pressure/temperature graph <sup>2)</sup>

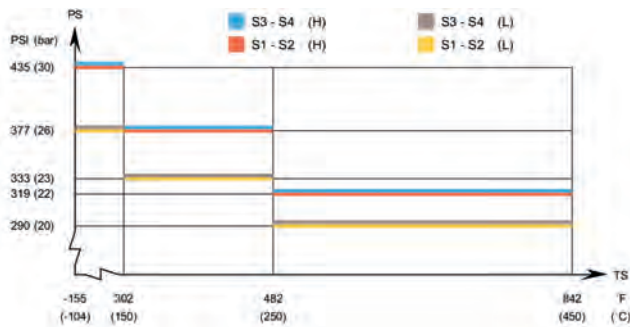

AlfaNova 27 – CRN approval pressure/temperature graph <sup>2)</sup>

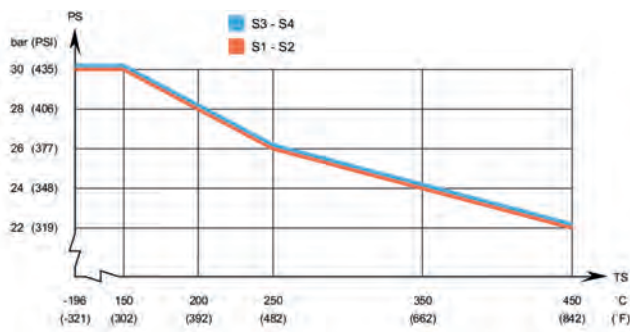

<sup>2)</sup> Min temperature -49 °F ( -45 °C) with connection tube made of carbon steel.

### Standard data

Min. working temperature	see graph
Max. working temperature	see graph
Min. working pressure	vacuum
Max. working pressure	see graph
Volume per channel, litres (ga)	0.05 (0.013)
Max. particle size mm (inch)	1.2 (0.05)
Max. flowrate* m <sup>3</sup> /h (gpm)	14 (61.6)
Min. nbr of plates	6
Max. nbr of plates	100

\* Water at 5 m/s (16.4 ft/s) (connection velocity)

### Standard dimensions \*

A measure mm	= 11 + (2.42 * n) ±4.5 mm
A measure inch	= 0.43 + (0.1 * n) ±0.18 inch
Weight kg	= 1 + (0.13 * n)
Weight lb	= 2.2 + (0.29 * n)

### Standard materials

Cover plates	Stainless steel
Connections	Stainless steel
Plates	Stainless steel
AlfaFusion filler	Stainless steel

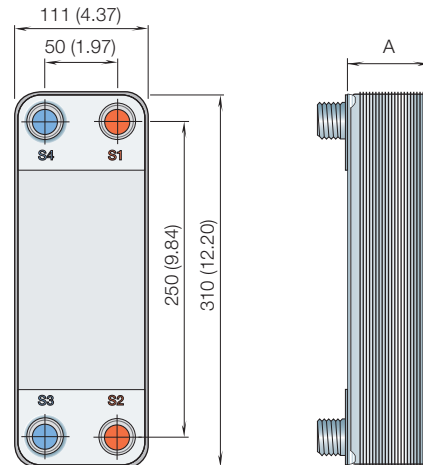

For exact values please contact your local Alfa Laval representative.

### How to contact Alfa Laval

Up-to-date AlfaLaval contact details for all countries are always available on our website on [www.alfalaval.com](http://www.alfalaval.com)



# AlfaNova 52

## Fusion-bonded plate heat exchanger

### General information

AlfaNova is a plate heat exchanger made of 100% stainless steel. It is based on Alfa Laval's revolutionary technology, AlfaFusion, the art of joining stainless steel components together.

AlfaNova heat exchangers are well suited in applications which put high demand on cleanliness, applications where ammonia is used or applications where copper or nickel contamination is not accepted. Its high resistance to corrosion makes it both hygienic and environmental friendly.

It is extremely compact compared to its capacity to withstand great strains in demanding heat transfer applications.

### Applications

Within refrigeration:

- Oil cooling
- Condensing
- Evaporating
- Economizing
- Desuperheating
- Absorption systems

Other main applications:

- Domestic hot water
- Process cooling
- Hydraulic oil cooling
- Laser cooling
- Hygienic/sanitary
- Water/water cooling & heating

### Working principles

The heating surface consists of thin corrugated metal plates stacked on top of each other. Channels are formed between the plates and corner ports are arranged so that the two media flow through alternate channels, always in countercurrent flow. The media are kept in the unit by a bonded seal around the edge of the plates. The contact points of the plates are also bonded to withstand the pressure of the media handled.

### Standard design

The plate pack is covered by cover plates. Connections are located in the front or rear cover plate. The channel plates are corrugated to improve heat transfer design.



### Particulars required for quotation

To enable Alfa Laval's representative to make a specific quotation, enquiries should be accompanied by the following particulars:

- Flow rates or heat load required
- Temperature program
- Physical properties of liquids in question
- Desired working pressure
- Maximum permitted pressure drop

### Examples of connections

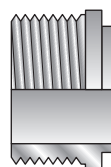

External threaded

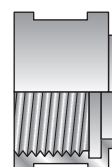

Internal threaded

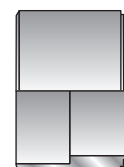

Soldering

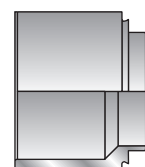

Welding

AlfaNova 52 – PED approval pressure/temperature graph <sup>1)</sup>

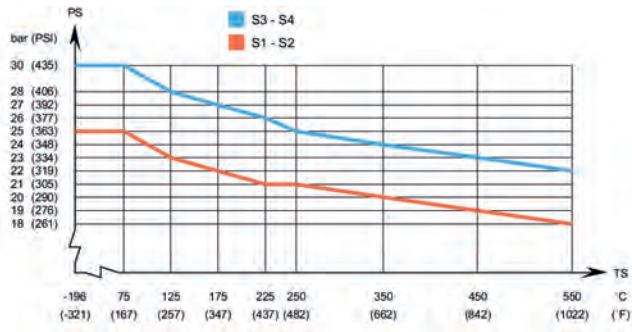

<sup>1)</sup> Min. temperature -10°C (14°F) with connection tube made of carbon steel.

AlfaNova 52 – ASME approval pressure/temperature graph <sup>2)</sup>

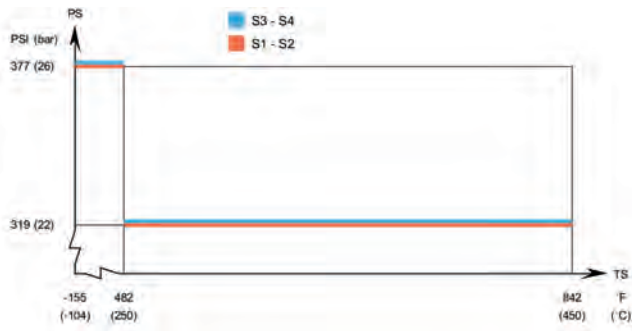

AlfaNova 52 – CRN approval pressure/temperature graph <sup>2)</sup>

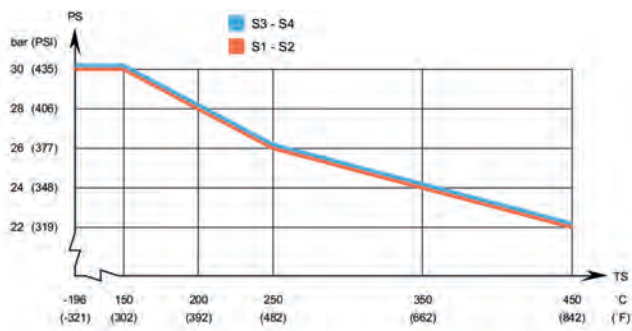

<sup>2)</sup> Min. temperature -49°F (45°C) with connection tube made of carbon steel.

## Standard data

Min. working temperature	see graph
Max. working temperature	see graph
Min. working pressure	vacuum
Max. working pressure	see graph
Volume per channel, litres (ga)	0.095 (0.025)
Max. particle size mm (inch)	1.2 (0.05)
Max. flowrate* m <sup>3</sup> /h (gpm)	14 (61.6)
Min. nbr of plates	6
Max. nbr of plates	150

\*) Water at 5 m/s (16.4 ft/s) (connection velocity)

## Standard dimensions \*

A measure mm	=	11 + (2.48 * n) ±4.5 mm
A measure inch	=	0.43 + (0.1 * n) ±0.18 inch
Weight kg	=	1.9 + (0.22 * n)
Weight lb	=	4.19 + (0.49 * n)

## Standard materials

Cover plates	Stainless steel
Connections	Stainless steel
Plates	Stainless steel
AlfaFusion filler	Stainless steel

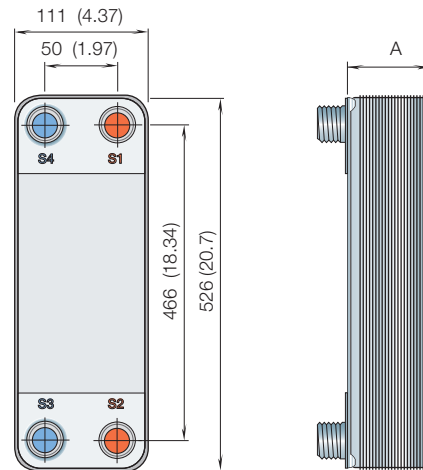

For exact values please contact your local Alfa Laval representative.

### How to contact Alfa Laval

Up-to-date AlfaLaval contact details for all countries are always available on our website on [www.alfalaval.com](http://www.alfalaval.com)



# AlfaNova 76

## Fusion-bonded plate heat exchanger

### General information

AlfaNova is a plate heat exchanger made of 100% stainless steel. It is based on Alfa Laval's revolutionary technology, AlfaFusion, the art of joining stainless steel components together.

AlfaNova heat exchangers are well suited in applications which put high demand on cleanliness, applications where ammonia is used or applications where copper or nickel contamination is not accepted. Its high resistance to corrosion makes it both hygienic and environmental friendly.

It is extremely compact compared to its capacity to withstand great strains in demanding heat transfer applications.

### Applications

Within refrigeration:

- Oil cooling
- Condensing
- Evaporating
- Economizing
- Desuperheating
- Absorption systems

Other main applications:

- Domestic hot water heating
- Process cooling
- Hydraulic oil cooling
- Laser cooling
- Hygienic/sanitary
- Water/water cooling & heating

### Working principles

The heating surface consists of thin corrugated metal plates stacked on top of each other. Channels are formed between the plates and corner ports are arranged so that the two media flow through alternate channels, always in countercurrent flow. The media are kept in the unit by a bonded seal around the edge of the plates. The contact points of the plates are also bonded to withstand the pressure of the media handled.

### Standard design

The plate pack is covered by cover plates. Connections are located in the front or rear cover plate. The channel plates are corrugated to improve heat transfer design.

### Standard materials

Cover plates	Stainless steel
Connections	Stainless steel
Plates	Stainless steel
AlfaFusion filler	Stainless steel



### Particulars required for quotation

To enable Alfa Laval's representative to make a specific quotation, enquiries should be accompanied by the following particulars

- Flow rates or heat load required
- Temperature program
- Physical properties of liquids in question
- Desired working pressure
- Maximum permitted pressure drop

### Examples of connections

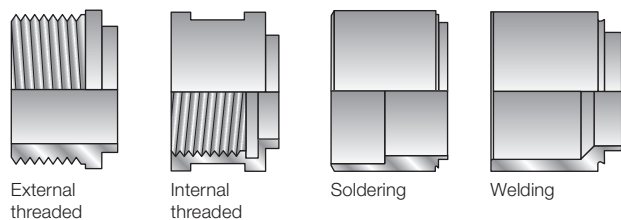



AlfaNova 76 – PED approval pressure/temperature graph <sup>1)</sup>

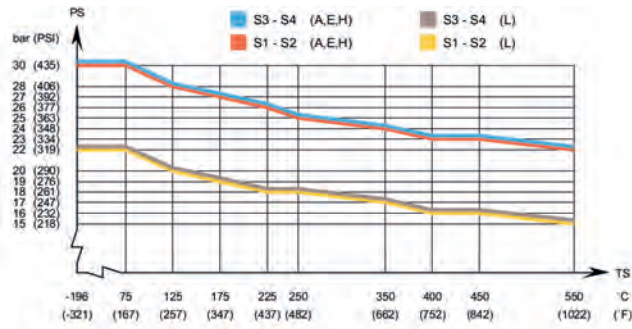

<sup>1)</sup> Min. temperature -10°C (14°F) with connection tube made of carbon steel.

AlfaNova 76 – ASME approval pressure/temperature graph <sup>2)</sup>

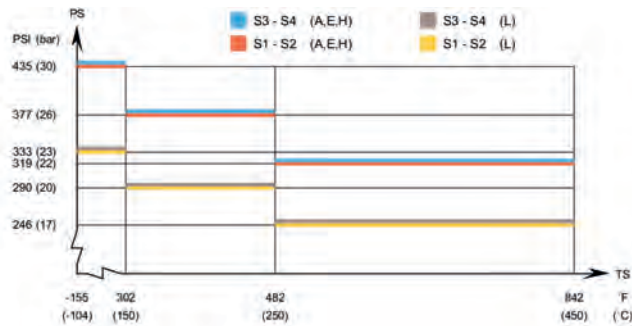

<sup>2)</sup> Min. temperature -49°F (14-45°C) with connection tube made of carbon steel.

AlfaNova 76 – CRN approval pressure/temperature graph

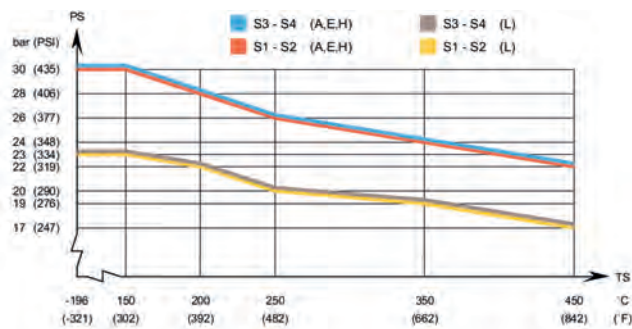

AlfaNova 76 – KHK approval pressure/temperature graph

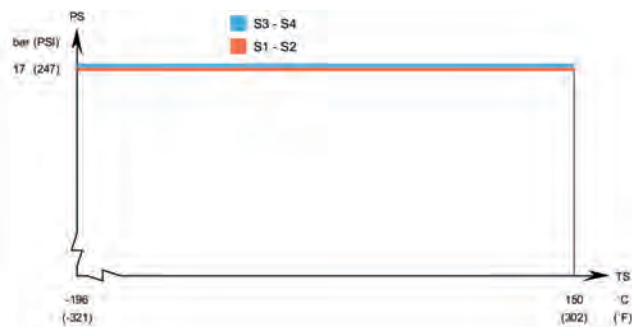

Standard data

Min. working temperature	see graph
Max. working temperature	see graph
Min. working pressure	vacuum
Max. working pressure	see graph
Volume per channel A, litres (ga)	0.25 (0.065)
	0.18 (0.046)
Volume per channel H, L, litres (ga)	0.25 (0.065)
Volume per channel E, litres (ga)	0.18 (0.046)
Max. particle size mm (inch)	1.2 (0.047)
Max. flowrate* m <sup>3</sup> /h (gpm)	37 (163)
Min. nbr of plates	10
Max. nbr of plates	150

\*) Water at 5 m/s (16.4 ft/s) (connection velocity)

Standard dimensions

L channel	A measure mm	= 13 + (2.85 * n) ±5 mm
	A measure inch	= 0.51 + (0.11 * n) ±0.2 inch
H channel	A measure mm	= 11 + (2.85 * n) ±5 mm
	A measure inch	= 0.43 + (0.11 * n) ±0.2 inch
A channel	A measure mm	= 11 + (2.56 * n) ±5 mm
	A measure inch	= 0.43 + (0.1 * n) ±0.2 inch
E channel	A measure mm	= 11 + (2.29 * n) ±5 mm
	A measure inch	= 0.43 + (0.09 * n) ±0.2 inch
H, A, E channels	Weight** kg	= 8 + (0.49 * n)
	Weight** lb	= 17.64 + (1.08 * n)
L channel	Weight** kg	= 8 + (0.42 * n)
	Weight** lb	= 17.64 + (0.93 * n)

(n = number of plates)

\*\* Excluding connections

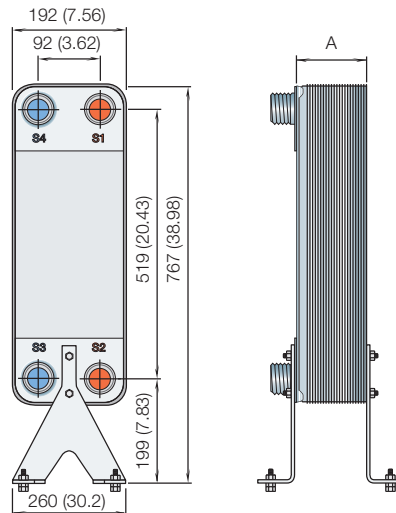

For exact values please contact your local Alfa Laval representative.

How to contact Alfa Laval

Up-to-date AlfaLaval contact details for all countries are always available on our website on [www.alfalaval.com](http://www.alfalaval.com)



# AlfaNova 400

## Fusion-bonded plate heat exchanger

### General information

AlfaNova is a plate heat exchanger made of 100% stainless steel. It is based on Alfa Laval's revolutionary technology, AlfaFusion, the art of joining stainless steel components together.

AlfaNova heat exchangers are well suited in applications which put high demand on cleanliness, applications where ammonia is used or applications where copper or nickel contamination is not accepted. Its high resistance to corrosion makes it both hygienic and environmental friendly.

It is extremely compact compared to its capacity to withstand great strains in demanding heat transfer applications.

### Applications

- Evaporating
- Economizing
- Absorption systems
- Process cooling/heating
- Oil cooling

### Working principles

The heating surface consists of thin corrugated metal plates stacked on top of each other. Channels are formed between the plates and corner ports are arranged so that the two media flow through alternate channels, always in countercurrent flow. The media are kept in the unit by a bonded seal around the edge of the plates. The contact points of the plates are also bonded to withstand the pressure of the media handled.

### Standard design

The plate pack is covered by cover plates. Connections are located in the front or rear cover plate. The channel plates are corrugated to improve heat transfer design.

### Particulars required for quotation

To enable Alfa Laval's representative to make a specific quotation, enquiries should be accompanied by the following particulars:

- Flow rates or heat load required
- Temperature program
- Physical properties of liquids in question
- Desired working pressure
- Maximum permitted pressure drop



### Examples of connections

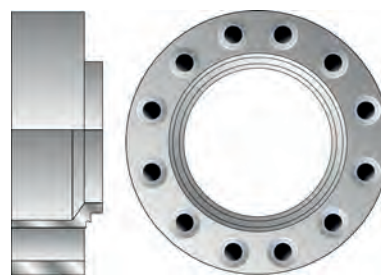

Compact flanges



Welding

Clamp

Soldering

Outside threaded

AlfaNova 400 – PED approval pressure/temperature graph <sup>1)</sup>

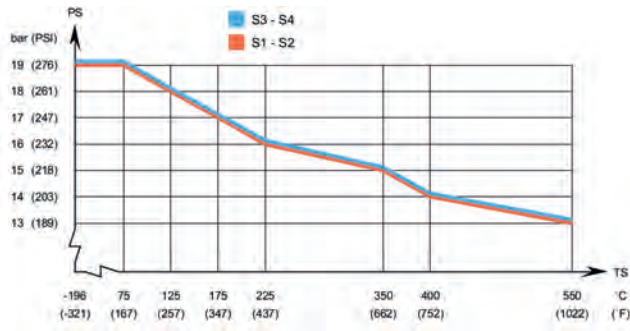

<sup>1)</sup> Min temperature -50 °C (-58 °F) with connection tubes made of carbon steel.

AlfaNova 400 – ASME approval pressure/temperature graph <sup>2)</sup>

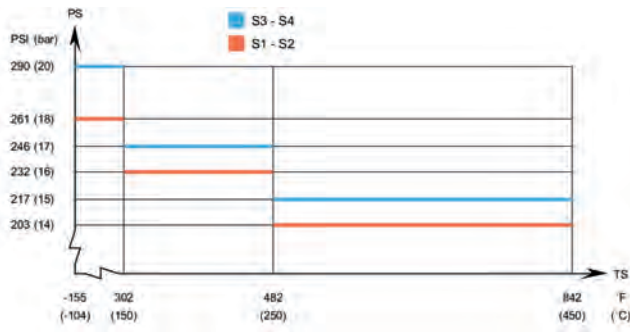

<sup>2)</sup> Min temperature -49 °F (-45 °C) with connection tubes made of carbon steel.

AlfaNova 400 – KHK approval pressure/temperature graph

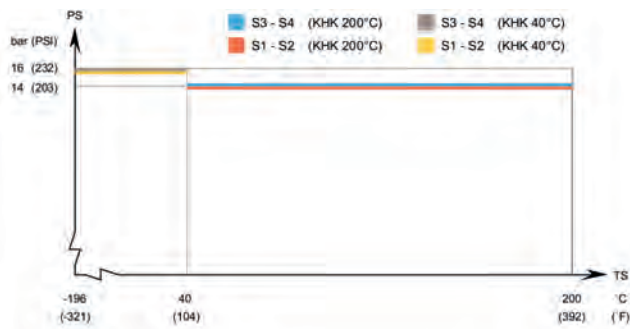

AlfaNova 400 – CRN approval pressure/temperature graph

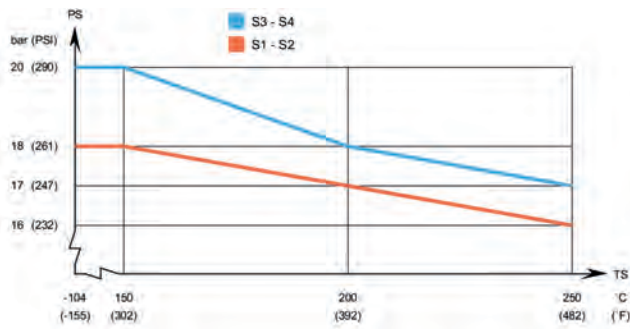

## Standard data

Min. working temperature	see graph
Max. working temperature	see graph
Min. working pressure	vacuum
Max. working pressure	see graph
Volume per channel, litres (ga)	0.74 (0.19)
Max. particle size mm (inch)	1.8 (0.07)
Max. flowrate* m <sup>3</sup> /h (gpm)	200 (880)
Min. nbr of plates	10
Max. nbr of plates	270
*) Water at 5 m/s (16.4 ft/s) (connection velocity)	

## Standard materials

Cover plates	Stainless steel
Connections	Stainless steel
Plates	Stainless steel
AlfaFusion filler	Stainless steel

## Standard dimensions \*

A measure mm	=	14 + (2.65 * n) ± 10 mm
A measure inch	=	0.55 + (0.1 * n) ± 0.39 inch
Weight kg	=	22 + (1.4 * n)
Weight lb	=	48.5 + (3.09 * n)

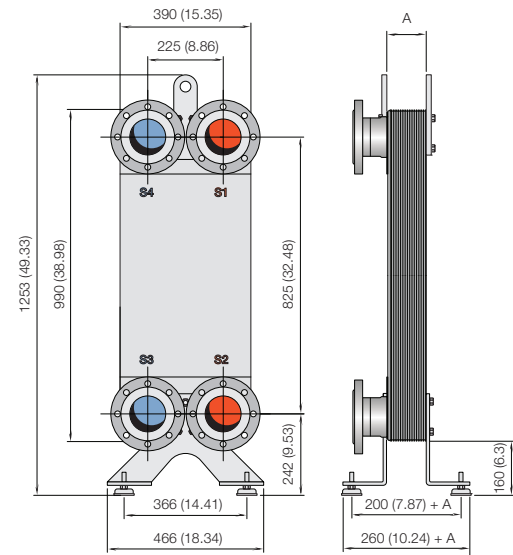

For exact values please contact your local Alfa Laval representative.

### How to contact Alfa Laval

Up-to-date AlfaLaval contact details for all countries are always available on our website on [www.alfalaval.com](http://www.alfalaval.com)



# Chapter 9

1. The Alfa Laval Group
2. Heating and cooling solutions from Alfa Laval
3. Applications
4. The theory behind heat transfer
5. Product range
6. Gasketed plate heat exchangers
7. Brazed plate heat exchangers
8. Fusion-bonded plate heat exchangers, AlfaNova
- 9. Air heat exchangers**
10. All-welded heat exchangers
11. Filters





# Air heat exchangers

It's all in the air. And it's all thanks to air heat exchangers – indoor and outdoor units capable of capturing, conditioning and distributing the right air in the right place with the right efficiency.

In other words, air heat exchangers from Alfa Laval.

As a leading supplier to the air-conditioning industry, Alfa Laval offers a complete line of dry coolers, condensers and air heaters for indoor cooling and heating. In combination with our brazed and gasketed plate heat exchangers, they live up to every requirement.





## Industrial dry coolers

Alfa Laval's air-cooled dry coolers are made with cross-fin copper tubes and advanced corrugated aluminium fins, which results in a combination of compact dimensions and high capacity. They are available with both copper and stainless-steel tubing (for pure oil applications, such as Transformer oil cooling).

Alfa Laval dry coolers are typically used for cooling water, brine, oil and cooling agents. They are common in industrial cooling systems and are needed when different processes generate heat that needs to either be dissipated or recovered.

Dry coolers present an excellent alternative to conventional cooling towers. Because there is no water consumption, the risk for legionella bacterial growth is virtually zero. The energy consumption is also generally lower.



AlfaBlue air-cooled condenser.

All Alfa Laval dry coolers are easily integrated with Alfa Laval's liquid-cooled plate heat exchangers.

Air-cooled dry coolers from Alfa Laval are available in three basic configurations – single-fan row, dual-fan row and V-shaped. They all combine an eye-pleasing appearance with a robust, highly corrosion-resistant design.

They are intended for heavy duty operation in temperatures between  $-50^{\circ}\text{C}$  and  $+120^{\circ}\text{C}$ . To minimize the pressure drop, they are fitted with smooth copper tubes. Noise levels and energy consumption are remarkably low, thanks to variable-speed EC fan motors.



Special heavy-duty air-cooled condensers and dry coolers for use in adverse conditions.





AlfaBlue dry cooler.



The V-shaped design of Alfa V dry coolers results in large capacity and compact dimensions.



**Main benefits:**

- High cooling efficiency thanks to optimized heat-transfer surfaces.
- Wide range of options and accessories for increased versatility.
- Variable-speed EC fan technology, reducing noise levels and energy consumption.
- Reliable performance, certified by Eurovent
- Robust and corrosion-resistant design, suitable for heavy industrial duties.
- Low maintenance costs and long operational life.
- Energy Efficiency Class certified.
- Compact dimensions, securing high capacity per sqm of footprint.
- Modular design – pay for what you need
- Noise levels to meet every demand
- Optional non-standard fin spacing for dusty environments.

Stainless-steel flange connections are standard on Alfa V and dual fan-row AlfaBlue dry coolers.



Variable-speed EC fan motors combine efficiency with low power consumption. They are available in many sizes with many options.



The optional safety switch.





## AlfaBlue transformer oil cooler – advanced technology, rugged exterior

**When the AlfaBlue oil cooler was designed, transformer manufacturers were asked to list their specific needs. At the top of the list was a rugged industrial design to withstand tough conditions.**

### **Rugged casing to withstand the toughest conditions**

The frame design and construction of the AlfaBlue oil cooler provide high rigidity for protection against vibration and thermal shocks. The casing is made in hot dip galvanized steel and painted with primer and top coating. All parts are painted separately before assembly to avoid any form of corrosion. As a result, the casing is available in corrosion class C4 as standard, and C5 on demand.



An AlfaBlue transformer oil cooler in the last stage of production at Alfa Laval's air heat exchanger factory in Italy.

### **Innovative coil construction**

The AlfaBlue oil cooler offers high cooling efficiency thanks to optimized heat-transfer surfaces. The tube configuration comes in a variety of options.

Corrugated fins can be supplied in various materials and treatments for longest lifetime in each application. Manufactured in aluminium as standard the fins can also be in Seaworthy aluminium (suitable for offshore installations), copper, epoxy coated aluminium, and with F-Coat or Blygold treatment.

### **Latest fan motor technology**

The AlfaBlue oil cooler incorporates the latest fan motor technology with state-of-the-art, low-noise blade design. Several fan impeller profiles and rotation speeds are available to meet the requested noise level. The fan and motor are a complete package that, if necessary, can be replaced simply and easily without dismantling.

The motor is equipped with an external rotor. Integrated thermo contacts provide reliable protection against thermal overload. Energy saving, variable-speed EC (Electrically Commutated) fans are available as an option.



AlfaBlue transformer oil cooler

### **AlfaBlue oil cooler – benefits**

- Heavy duty design with high corrosion resistance
- Easily cleanable thanks to removable fan motors and industrial power fins
- Fully assembled: easy to connect to the transformer
- Reduced fan motor power consumption as a result of low static pressure
- Excellent sound characteristics
- Reliable performance
- Easy installation & maintenance
- Energy efficient – low total cost of ownership
- Two-year product guarantee.





## Your complete air-cooling partner.

### Why complicate your business when you can get all you need from one supplier?

You probably know that Alfa Laval offers some of the best products in the world when it comes to heat transfer – including air cooling. Our experience goes back almost a century, our know-how is based on thousands of installations globally. And as a world market leader, we continue to push technology forward.

But Alfa Laval is first and foremost about solutions. Our worldwide organization is there for you all the way. From planning and design, through installation and operation, to our Nonstop-Performance service concept. Our single-minded goal is to achieve maximum uptime and low life-cycle cost in every project we are involved in.

So, if you are in an industry where you need efficient, reliable cooling, optimized to your applications, Alfa Laval can make it easy for you. Time and again, anywhere in the world.

### Globally local

Alfa Laval's business activities focus on facilitating our customers' operations.

We provide you with technologies and solutions that will help you optimize your operations and processes and keep them running smoothly year after year.

With our global network of sales companies, we are always close to you, regardless of where in the world you do business. That's how we can offer you fast and reliable deliveries and ensure non-stop performance.



### Spare-part service

Alfa Laval's resources for spare-part service are second to none – ensuring a timely turn-around virtually anywhere in the world. Thanks to a truly worldwide organization, customer support and trouble-shooting are available on local, regional and global levels.





# Air heat exchangers range

<p><b>AlfaBlue Junior DG</b></p>	<p><b>AlfaBlue</b> BDM/BDMY/BDD/BDD6/BDDY</p>	<p><b>AlfaBlue Reverse</b></p>
<p>Read all about it on page 9:7</p>	<p>Read all about it on page 9:9</p>	<p>Read all about it on page 9:11</p>
 <p>Dry cooler</p>	 <p>Dry cooler</p>	 <p>Air-cooled radiator</p>
<p><b>AlfaBlue Power BDP</b></p>	<p><b>AlfaBlue BO</b></p>	<p><b>Fincoil FBLG</b></p>
<p>Read all about it on page 9:13</p>	<p>Read all about it on page 9:15</p>	<p>Read all about it on page 9:17</p>
 <p>Air-cooled radiator</p>	 <p>Air-cooled transformer</p>	 <p>Air-cooled radiator</p>
<p><b>DCH</b></p>	<p><b>Alfa-V Single Row VDM</b></p>	<p><b>Alfa-V VDD/VDD6/VDDY</b></p>
<p>Read all about it on page 9:19</p>	<p>Read all about it on page 9:21</p>	<p>Read all about it on page 9:23</p>
 <p>Gen-set radiator</p>	 <p>Dry cooler</p>	 <p>Dry cooler</p>
<p><b>AlfaSolar SD</b></p>		
<p>Read all about it on page 9:25</p>		
 <p>Dry cooler</p>		





# AlfaBlue Junior DG

## Dry coolers – commercial range

### General information & application

In addition to the well-proven AlfaBlue dry cooler line, the new generation of AlfaBlue Junior commercial dry coolers is a competitive product line of robust construction and high rigidity, that has every feature you need.

AlfaBlue Junior offers excellent performance especially at low air flow rates, allowing easy installation on site and an outstanding integration with other components. Highly efficient fan motors combine excellent sound characteristics and low energy consumption.

AlfaBlue Junior dry coolers are often used for cooling down condenser water in air-conditioning and refrigeration installations. In the processing industry, dry coolers are suitable for closed circuit cooling of various process liquids.

### Coil

An innovative coil design based on 10 mm copper tubes and corrugated aluminium turbo fins provides excellent heat transfer at a limited internal volume. Standard fin spacing is 2.1 mm.

### Casing

The coil frame is made from AlMg<sub>3</sub> for protection against vibration and thermal expansion. Casing material is galvanized steel sheet, pre-painted with an epoxy finish (RAL9002). Separated fan sections.

### Fan motors

High efficiency AC or EC fans with innovative polymeric fan blades and low power consumption. Available in two fan diameters (500 & 630 mm), different power supplies (230/50-60/1, 400/50-60/3) and four noise levels.

Protection class IP 54 according to DIN 40050.

AC motors are fitted with integrated thermo contacts to provide reliable protection against thermal overload (terminals in the box). Motors may be wired to one or more common terminal boxes.

### Options

- Safety switches (SW)
- Terminal box for electric power connection (CB)
- Fan speed control 230/1 and 400/3 (BFT)
- Flanges (aluminium)
- End covers (CV)
- Coil corrosion protection
  - Fins epoxy coated (EP)
  - Fins seawater resistant aluminium alloy 57S/5052 (SWR)
  - Blygold treatment (BY)
  - F-coat treatment (FC)

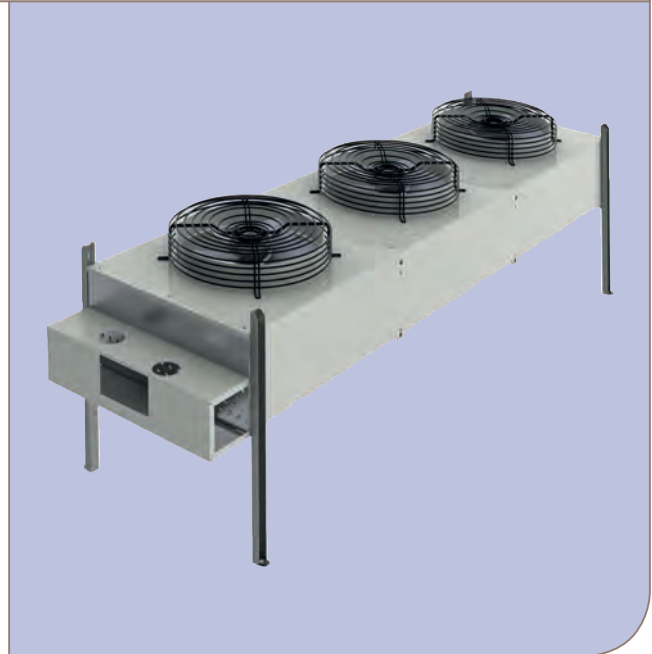

AlfaBlue Junior DG

- Fin spacing 2.5 mm
- Vibration dampers (VD)

### Customisation (on request)

- Reverse setup (fitted with blow through fans, for high air-in temperature applications)

### Certifications

All dry cooler models are “Eurovent Certify All” certified. The Alfa Laval quality system is in accordance with ISO 9001. All products are manufactured according to CE and PED rules.

### Design pressure

Design pressure 6 bar. Each heat exchanger is leak tested with dry air.

### Selection

Selection and pricing is to be performed with our Alfa Laval air heat exchanger selection software. Please contact our sales organization for details and full technical documentation.



type	fans	Dimensions										Weight			
		L mm	H mm	W mm	H2 mm	W2 mm	M1 mm	M2 mm	M3 mm	M4 mm	M5 mm	Coil A kg	Coil A kg	Coil A kg	
DG*501	1	1115	846	868	828	428	860	-	-	-	868	420	39	42	47
DG*502	2	2015	846	868	828	428	1760	-	-	-	868	420	76	85	93
DG*503	3	2915	846	868	828	428	2660	-	-	-	868	420	111	123	137
DG*504	4	3815	846	868	828	428	1800	1840	-	-	868	420	-	179	192
DG*631	1	1261	1180	1070	1034	680	960	-	-	-	1070	700	87	93	99
DG*632	2	2261	1180	1070	1034	680	1960	-	-	-	1070	700	164	176	188
DG*633	3	3261	1180	1070	1034	680	2960	-	-	-	1070	700	242	259	277
DG*634	4	4261	1180	1070	1034	680	3960	1960	-	-	1070	700	318	343	366
DG*635	5	5261	1180	1070	1034	680	4960	1960	2000	-	1070	700	374	403	434
DG*636	6	6261	1180	1070	1034	680	5960	1960	2000	-	1070	700	448	484	519

NOTE: weights for DG\*6 are given for sound execution S (Standard). Weights for executions L, Q & R are 92% of the given values.

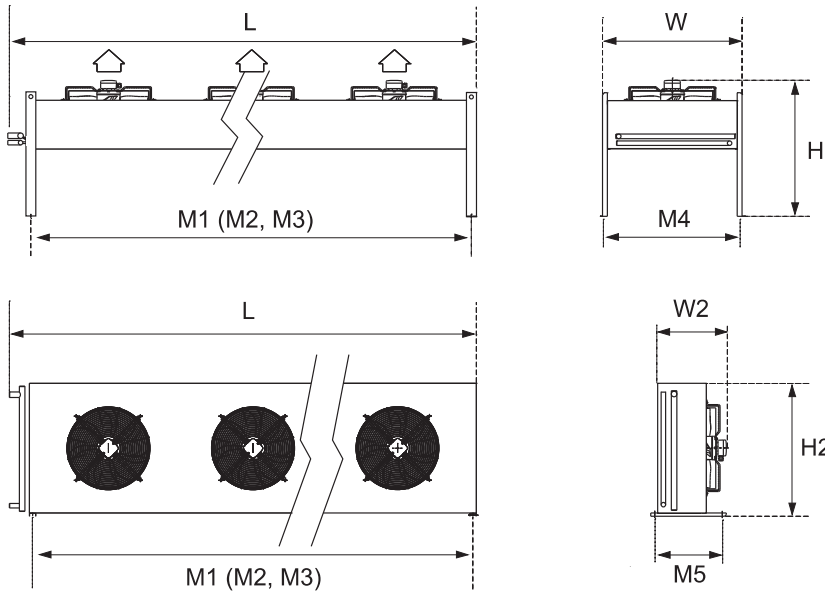

### Code description

DG	S(E)	50	2	B	D	H/V	BO	*	-	AL	2.1	CU	*
1	2	3	4	5	6	7	8	9		10	11	12	13

- AlfaBlue Junior dry cooler
- Sound level/fan code (S-standard, L=low, Q=quiet, R=residential, E=EC fan motor)
- Fan diameter (50=500 mm, 63=630 mm)
- Number of fans (1 to 6)
- Tube rows code (A, B, C)
- Phases (S=monophase, D=three phases)
- Suitable for both horizontal & vertical installation
- Transport packing (BO=box, P=pallet, CR=crate)
- Options
- Fin material/coating (AL=aluminium, IF=industrial fins, SWR=AlMg2.5, EP=epoxy coated alu, FC=F-coat, BY=Blygold)
- Fins spacing (2.1 mm, 2.5 mm)
- Tube material (CU=copper)
- Extra options

### Benefits

- Excellent sound characteristics, suitable for residential applications
- Reliable performance, Eurovent certified
- Easy installation & maintenance.
- Energy efficient - low total cost of ownership.
- Damage-proof packing in sturdy cardboard box on pallet. Bigger units in a crate and wrapped with plastic foil.
- Two-year product guarantee.

ERC00259EN 1210

Alfa Laval reserves the right to change specifications without prior notification.

### How to contact Alfa Laval

Up-to-date AlfaLaval contact details for all countries are always available on our website on [www.alfalaval.com](http://www.alfalaval.com)







# AlfaBlue BDM / BDMY / BDD / BDD6 / BDDY

## Dry coolers

### General information & application

The AlfaBlue series is a wide range of heavy-duty dry coolers. Dry coolers are often used for cooling down condenser water in air conditioning and refrigeration installations. In the processing industry, dry coolers are suitable for closed circuit cooling of various process liquids. With a wide range of sound pressure level alternatives, these units are particularly suited to demanding, noise sensitive environments. AlfaBlue dry coolers are available for both horizontal and vertical air direction, either in single (M) or dual (D) coil execution.

Capacities \* 16 up to 1028 kW  
 \* water, EN1048.

### Coil

An innovative coil design provides excellent heat transfer. In standard execution dry coolers are fitted with smooth copper tubing (1/2", 3/8" or 5/8") or stainless steel tubing (5/8"). Fins in aluminium or sea water resistant AlMg2.5, available in two fin designs:

Turbo fins	maximized capacity
Industrial power fins (IF)	long lasting performance

Available in different fin thicknesses and fin spacings. Coil configuration optimized according to liquid flow. Separate connections in the D series provide the opportunity for independent operation of both coils.

### Casing

Frame construction provides high rigidity for protection against vibration and thermal expansion. Casing and framework of corrosion resistant pre-galvanized sheet steel (high corrosion resistance), epoxy coated white RAL 9002 on both sides. Separated fan sections.

### Fan motors

Available in four fan diameters (630, 800, 910 & 1000 mm) and five noise levels, power supply 400V/50/3. Motors with external rotor, protection class IP 54 according to DIN 40050. Integrated thermo contacts provide reliable protection against thermal overload. EC fan motors available.

### Options

- Spray water device (D series only)
- Vibration dampers (VD)
- Special fan motors 400V/60Hz
- Coil corrosion protection
  - Fins epoxy coated (EP)
  - Fins seawater resistant aluminium alloy 57S/5052 (SWR)
  - Copper fins
  - Blygold treatment (BY)
  - F-coat treatment (FC)



AlfaBlue BDD

- Electrical options
  - Safety switch (SW)
  - Motors wired to a common terminal box (CB)
  - Switchboard basic IP55 (B)
  - EMC approved components
  - Fan step control (BP/BSP), Fan speed control (BFP/BSFP) or Frequency control (BI/BIC)

### Customisation (on request)

- Multi-circuiting
- Special fan motors
  - 480/3/60 (IP54)
  - Protection class IP55
  - High-temperature or explosion proof motors

### Certifications

All dry cooler models are "Eurovent Certify All" certified. The Alfa Laval quality system is in accordance with ISO 9001. All products are manufactured according to CE and PED rules.

### Design pressure

Design pressure 6 bar. Each heat exchanger is leak tested with dry air.

### Selection

Selection and pricing is to be performed with our Alfa Laval air heat exchanger selection software. Please contact our sales organization for details and full technical documentation.

Dimensions mm (indicative)				
type	L1*	L2*	W	H
BDM 631	1545	1625	1214	1221
BDM 632	2635	2715	1214	1221
BDM 633	3725	3805	1214	1221
BDM 634	4815	4895	1214	1221
BDML 631	1855	1935	1214	1221
BDML 632	3255	3335	1214	1221
BDML 633	4655	4735	1214	1221
BDM 801	2205	2285	1454	1252
BDM 802	3955	4035	1454	1252
BDM 803	5705	5785	1454	1252
BDM 804	7455	7535	1454	1252
BDM 805	9205	9285	1454	1252
BDM 901	2555	2635	1454	1289
BDM 902	4655	4735	1454	1289
BDM 903	6755	6835	1454	1289
BDM 904	8855	8935	1454	1289
BDM 1001	2555	2635	1454	1295
BDM 1002	4655	4735	1454	1295
BDM 1003	6755	6835	1454	1295
BDM 1004	8855	8935	1454	1295
BDD 802	3955	4035	2249	1252
BDD 803	5705	5785	2249	1252
BDD 804	7455	7535	2249	1252
BDD 805	9205	9285	2249	1252
BDD 806	10955	11035	2249	1252
BDD 902	4655	4735	2249	1289
BDD 903	6755	6835	2249	1289
BDD 904	8855	8935	2249	1289
BDD 905	10955	11035	2249	1289
BDD 1002	4655	4735	2249	1278
BDD 1003	6755	6835	2249	1278
BDD 1004	8855	8935	2249	1278
BDD 1005	10955	11035	2249	1278

### Code description

BD	M	S(E)	80	5	B	D	CR	*	-	AL	2.1	CU	*
1	2	3	4	5	6	7	8	9		10	11	12	13

- AlfaBlue dry cooler (BDM/BDD = standard Cu tubes, BDD6 = 5/8" Cu tubes, BDMY/BDDY = SS304 tubes)
- Number of separated coils (M=1, D=2)
- Sound level/fan code (T=high performance, S=standard, L=low, Q=quiet, R=residential, E=EC fan motor)
- Fan diameter (63=630, 80=800, 90=910, 100=1000 mm)
- Number of fans per coil (BDM = 1 to 5, BDD = 2 to 6)
- No. of tube rows (A=2, B=3, C=4)
- Fan motor connection (D=delta, Y=star)
- Tube rows code (A, B, C)
- Packing (CR=crate, / mounting feet (Feet))
- Electrical options
- Fin material/coating (AL=aluminium, IF=industrial fins, SWR=AlMg2.5, EP=epoxy coated alu, FC=F-coat, BY=Blygold)
- Fins spacing (2.1, 2.3, 2.5, 3.0 and 3.2 mm)
- Tube material (CU=copper)

### Dimensions BDM

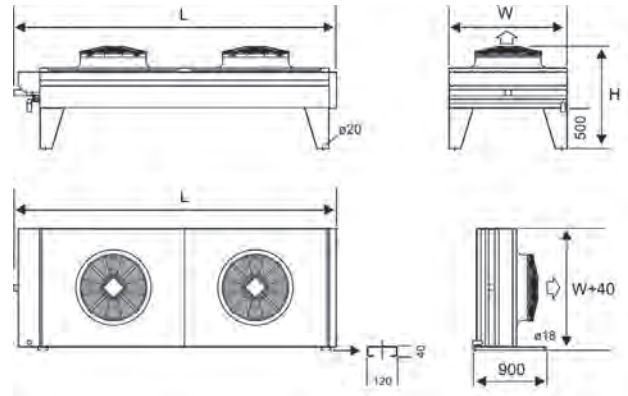

### Dimensions BDD

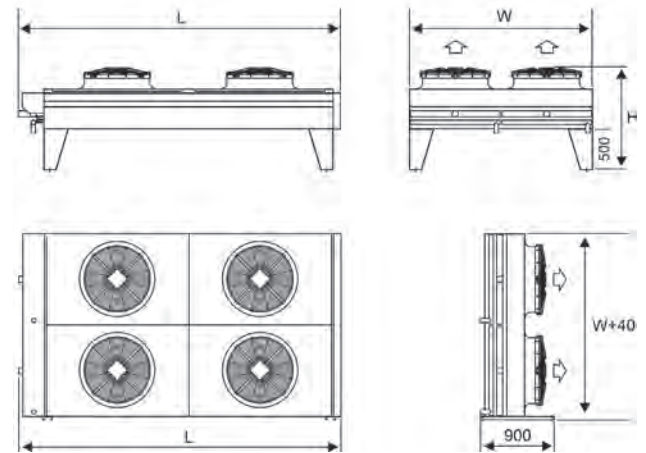

### Benefits

- Heavy duty design with high corrosion resistance
- Reduced refrigerant charge
- Available with easily cleanable industrial power fins
- Excellent sound characteristics
- Reliable performance, Eurovent certified
- Easy installation & maintenance.
- Energy efficient - low total cost of ownership.
- Two-year product guarantee.

ERC00032EN 1210

Alfa Laval reserves the right to change specifications without prior notification.

### How to contact Alfa Laval

Up-to-date AlfaLaval contact details for all countries are always available on our website on [www.alfalaval.com](http://www.alfalaval.com)





# AlfaBlue Reverse BR

## Air-cooled radiators

### General information & application

AlfaBlue Reverse is a range of heavy-duty radiators specifically designed for cooling high temperature process fluids.

Radiators are often used for cooling water or other liquids in process, steel, chemical and food industries, (bio)diesel & gas power plants etc. With a wide range of sound pressure level alternatives, these units are particularly suited to demanding, noise sensitive environments.

Liquids	All liquids that do not corrode copper
Capacities*	100 up to 4400 kW

\* (water, T<sub>air</sub>=35°C; T<sub>fluid in/out</sub>=90/70°C).

### Coil

An innovative coil design provides excellent heat transfer. In standard execution BR radiators are fitted with smooth copper tubing and industrial power fins for long lasting performance. Fin spacing 2.1 to 3.6 mm. Fin thickness gradually increases from standard thickness at 2.1 mm fin spacing to double fin thickness at 3.6 mm spacing. Coil configuration optimized according to liquid flow. Separate connections in the D series provide the opportunity for independent operation of both coils. Flanges aluminium (UNI EN 1092-4) and stainless steel flanges (UNI EN 1092-1).

### Casing

Frame construction provides high rigidity for stability and protection against vibration and thermal expansion. Casing & frame of corrosion resistant pregalvanized sheet steel (corrosion resistance class C4). Mounting feet galvanized steel. Separated fan sections.

### Fan motors

Fan diameter 910 mm, blowing through the coil. Available in four noise levels, power supply 400/50/3. Motors with external rotor, protection class IP 54 according to DIN 40050. Integrated thermo contacts provide reliable protection against thermal overload.

### Options

- Non-standard fin spacings
- Stainless steel tubes (SS)
- Multi-Circuiting
- Coil corrosion protection
  - Coil coating
  - Fins seawater resistant aluminium alloy 57S/5052



AlfaBlue BRD

- Casing epoxy coated (both sides)
- Coil protection grid
- Vibration dampers
- Electrical options
  - Safety switch (SW)
  - Motors wired to a common terminal box (CB)
  - Switchboard IP55
  - EMC approval
  - Fan step control
  - Fan speed control
  - Frequency control

### Certifications

The Alfa Laval quality system is in accordance with ISO 9001. All products are manufactured according to CE and PED rules.

### Design pressure

Design pressure 6 bar. Each heat exchanger is leak tested with dry air.

### Selection

Selection and pricing is to be performed with our Alfa Laval air heat exchanger selection software. Please contact our sales organization for details and full technical documentation.

Type	fans	Dimensions		
		W mm	L mm	H mm
BRC 901	1	1256	2200	1830
BRC 902	2	1256	4000	1830
BRC 903	3	1256	5800	1830
BRC 904	4	1256	7600	1830
BRC 905	5	1256	9400	1830
BRM 901	1	1736	2200	1830
BRM 902	2	1736	4000	1830
BRM 903	3	1736	5800	1830
BRM 904	4	1736	7600	1830
BRM 905	5	1736	9400	1830
BRD 902	4	2376	4000	2330
BRD 903	6	2376	5800	2330
BRD 904	8	2376	7600	2330
BRD 905	10	2376	9400	2330
BRD 906	12	2376	11200	2330
BRD 907	14	2376	13000	2330

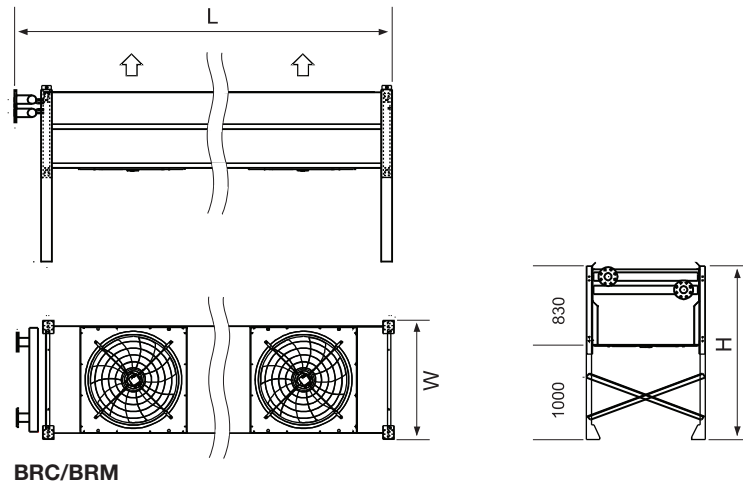

BRC/BRM

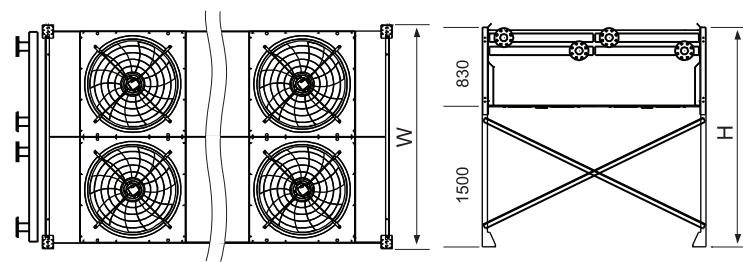

BRD

### Code description

BR	D	6	S	90	5	B	D	24	CR	*	-	AL	2.1	CU	*
1	2	3	4	5	6	7	8	9	10	11		12	13	14	15

- AlfaBlue Reverse radiato
- Fan rows (C=single fan row Compact, M=single fan row Medium, D=dual fan row)
- Tube diameter (only for BRD: default=12mm, 6=16 mm)
- Sound level/fan code (T=high performance, S=standard, L=low, Q=quiet)
- Fan diameter (90=910 mm)
- Number of fans per fan row (1-5 for BRC/BRM, 2-7 for BRD)
- No. of tube rows (A=2, B=3, C=4, D=5, E=6)
- Fan motor connection (D=delta, Y=star)
- Nr. of circuits
- Packing (CR=crate, P=pallet, SK=container skid)
- Electrical options
- Fin material/coating (AL=aluminium, FC=F-coat, BY=Blygold)
- Fin spacing (2.1, 2.3, 2.5 or 3.2 mm)
- Tube material (CU=copper)
- Options

### Benefits

- Heavy duty design with high corrosion resistance
- Easily cleanable industrial power fins & removable fan motors for coil washing
- Excellent sound characteristics
- Reliable performance
- Easy installation & maintenance
- Energy efficient - low total cost of ownership.
- Two-year product guarantee.

ERC00271EN 1210

Alfa Laval reserves the right to change specifications without prior notification.

### How to contact Alfa Laval

Up-to-date AlfaLaval contact details for all countries are always available on our website on [www.alfalaval.com](http://www.alfalaval.com)





# AlfaBlue Power BDP

## Air-cooled liquid coolers

### General information & application

AlfaBlue Power is a range of heavy-duty liquid coolers specifically designed for cooling industrial process fluids. These industrial liquid coolers are often used for cooling water or other liquids in process, steel, chemical and food industries.

Capacities\* 1180 up to 4940 kW  
 \* (water, T<sub>air</sub>=35°C; T<sub>fluid in/out</sub>=90/70°C).

### Coil

An innovative coil design provides excellent heat transfer. In standard execution radiators are fitted with smooth copper tubing and industrial power fins for long lasting performance. Available in different fin thicknesses, fin materials, fin spacings and surface treatments. Coil configuration optimized according to liquid flow. Flanges aluminium (UNI EN 1092-4) or stainless steel (UNI EN 1092-1).

AlfaBlue Power offers the possibility to have two separate sandwiched coils. This solution is used to combine HT & LT circuits in a single casing.

### Casing

Frame construction provides high rigidity for stability and protection against vibration and thermal expansion. Casing & frame are in Hot dip galvanized steel or Aluzinc. Optional: all casing parts 2-sided epoxy coating. Separated fan sections.

### Fan motors

Fan motors specifically designed for outdoor conditions, protection class IP55. Fan diameter 1440 mm, blowing through the coil. Power supply 400/50/3 or 460/60/3. Each motor is completely pre-wired to an isolating switch and fitted with a top protection cover.

### Certifications

The Alfa Laval quality system is in accordance with ISO 9001. All products are manufactured according to CE and PED rules.



AlfaBlue Power with handrail, ladder & support structure.

### Design pressure

Design pressure 9 bar. Each heat exchanger is leak tested with dry air.

### Selection

For selection and support please contact your local Alfa Laval representative.



Alfa Laval liquid cooler platform



Model	fans	L mm	W mm	H mm	Weight kg
BDP 2*/8-159	2	3555	2330	1060	1100
BDP 3*/8-159	3	5145	2330	1060	1500
BDP 4*/8-159	4	6735	2330	1060	2100
BDP 5*/8-159	5	8325	2330	1060	2600
BDP 6*/8-159	6	9915	2330	1060	3200
BDP 7*/8-159	7	11505	2330	1060	3700
BDP 8*/8-159	8	13095	2330	1060	4200
BDP 2*/8-185	2	4075	2330	1060	1300
BDP 3*/8-185	3	5925	2330	1060	1900
BDP 4*/8-185	4	7775	2330	1060	2400
BDP 5*/8-185	5	9625	2330	1060	3000
BDP 6*/8-185	6	11475	2330	1060	3600
BDP 7*/8-185	7	13325	2330	1060	4300
BDP 2*/8-200	2	4375	2330	1060	1300
BDP 3*/8-200	3	6375	2330	1060	1900
BDP 4*/8-200	4	8375	2330	1060	2600
BDP 5*/8-200	5	10375	2330	1060	3200
BDP 6*/8-200	6	12375	2330	1060	4000
BDP 2*/8-222	2	4815	2330	1060	1450
BDP 3*/8-222	3	7035	2330	1060	2100
BDP 4*/8-222	4	9255	2330	1060	2900
BDP 5*/8-222	5	11475	2330	1060	3500
BDP 6*/8-222	6	13695	2330	1060	4400

### Options

- Larger fin spacings for dirty/dusty operating conditions
- Stainless steel tubes BDPY (Aisi 304 or 316L)
- Multi-Circuiting
- Sandwiched coils (HT + LT)
- Coil corrosion protection
  - Coil coating (Al-precoated or painted after production)
  - Cu fins
  - Fins seawater resistant aluminium alloy 57S/5052
- Fan plate hot dip galvanized
- Fan blade materials
  - Aluminium
  - Galvanized steel
  - Fiber glass
- Coil protection grid
- Handrail kit, ladder & steel support structure (H = 2 to 6 m)
- Vibration dampers
- Electrical options
  - Isolating switch
  - Motors wired to a common terminal box
  - Switchboard (IP55)
  - EMC approval
  - Fan step control
  - Fan speed control
  - Frequency control
  - Special fan motors (on request)

All models: connections on the same side

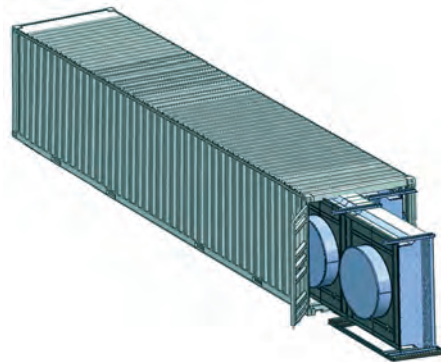
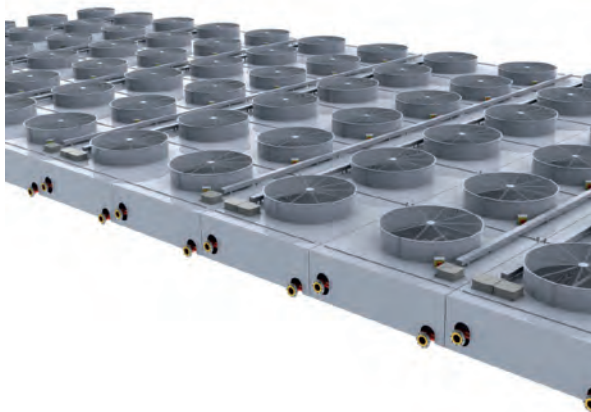

To reduce transport cost, AlfaBlue Power units are usually shipped in vertical position. An additional 50% reduction may be achieved by combining two units during transportation.

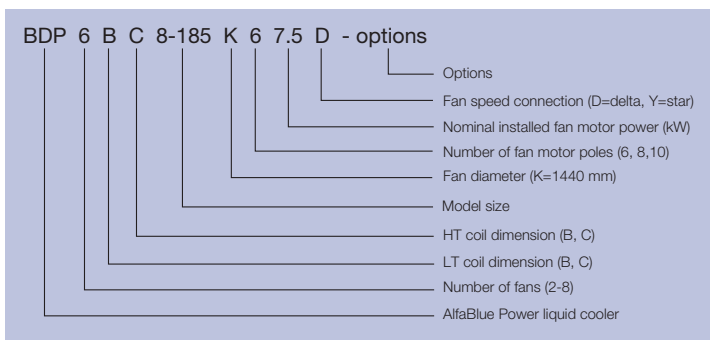

### Benefits

- Heavy duty design with high corrosion resistance
- Easily cleanable industrial power fins
- Reliable performance
- Easy installation & maintenance.
- Reduced transport cost
- Energy efficient - low total cost of ownership.
- Two-year product guarantee

ERC00272EN 1203

Alfa Laval reserves the right to change specifications without prior notification.

### How to contact Alfa Laval

Up-to-date AlfaLaval contact details for all countries are always available on our website on [www.alfalaval.com](http://www.alfalaval.com)





# AlfaBlue BO

## Air-cooled transformer oil coolers

### General information & application

The AlfaBlue BO series is a modular range of heavy-duty OFAF-type (Oil Forced/Air Forced) oil coolers, specifically designed for cooling transformer oil. AlfaBlue oil coolers are available for both on-board and remote installation.

Capacities  $\Delta T(T_{in}/oil - T_{in}/air) = 35^{\circ}C$  50 up to 600 kW

### Coil

An innovative coil design provides excellent heat transfer. In standard execution oil coolers are fitted with smooth copper tubing and industrial power fins for reduced fouling and long lasting performance. Available in different fin spacings (2.5 to 3.6 mm). Flanged connections, manifolds are provided with draining and venting nozzles. Coil corrosion protection is optional.

### Casing

Frame design and construction provides high rigidity for protection against (seismic) vibration and thermal shocks. Casing and framework of corrosion resistant pregalvanized sheet steel. Support plates (vertical installation) and mounting feet (horizontal installation) manufactured in galvanized steel. Finishing in RAL color optional.

### Fan motors

Fan motors with balanced aluminium fan blades, available in three fan diameters (800, 900 & 1000 mm) in a single fan row. Available with five noise/fan speed levels and in dual fan speed execution. Standard power supply 400/50/3, other power supplies on request. Motors with external rotor in accordance with VDE 0530/12.84. Protection class IP 54 according to DIN 40050. Integrated thermo contacts provide reliable protection against thermal overload.

### Options

- Aluminium tubes (Al)
- Coil corrosion protection
  - Coil coating F-coat (FC) or Blygold (BY)
  - Aluminium epoxy coated (EP)
  - Seawater resistant fins ALMg (SWR)
  - Copper fins (Cu)
  - Tinned copper fins & tubes
- Special fan motors (IP55, painted fan motors C3/C4/C5)
- Electrical options
  - Lockable safety switch (SW)
  - Central terminal connection box (CB)
- Coil protection grid
- Casing painted in RAL colour (P)
- Metal skid (SK)
- Seaworthy wooden packing box (WB)

### Installation and shipping

Oil coolers are available for on-board installation directly onto the transformer (I) or remote mounting in horizontal (H)



AlfaBlue transformer oil cooler for on-board installation

or vertical (V) setup. All on-board units are supplied with a re-usable metal skid permitting the transport of two units side by side on truck or container and lifting the product from horizontal to vertical position without risk of damaging the unit. Units for remote installation (H/V) are supplied on a wooden pallet, with the metal skid as an option. Seaworthy packaging is optional.

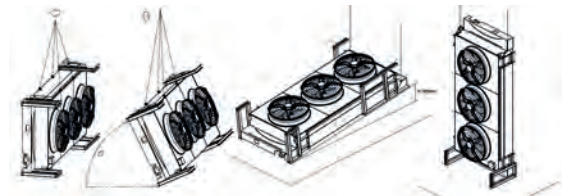

### Certifications

The Alfa Laval quality system is in accordance with ISO 9001. All products are manufactured according to CE and PED rules.

### Design pressure

Design pressure 9 bar (copper tubes) or 3 bar (alu tubes) at 100 °C. Each heat exchanger is leak tested with dry air and finally flushed with oil to remove any remaining particles.

### Selection

Selection and pricing is to be performed with our Alfa Laval air heat exchanger selection software. Please contact our sales organization for details and full technical documentation.

## Fin material guideline

Environmental conditions	Recommended fin material/coating					
	High grade aluminium	SWR AlMg2.5	Aluminium F-coat	Aluminium Blygold	Aluminium Epoxy coated	Copper Cu
Urban (low acid)	+	++	+++	+++	++	+
Industrial (acid)	-	+	++	++	+	-
Coastal (salty)	-	++	+++	+++	++	++
Desert (sandy)	+	++	+++	++	++	++
Marine (high salty)	-	++	++	++	+	++
Tropical (high humidity)	+	++	++	++	+	+

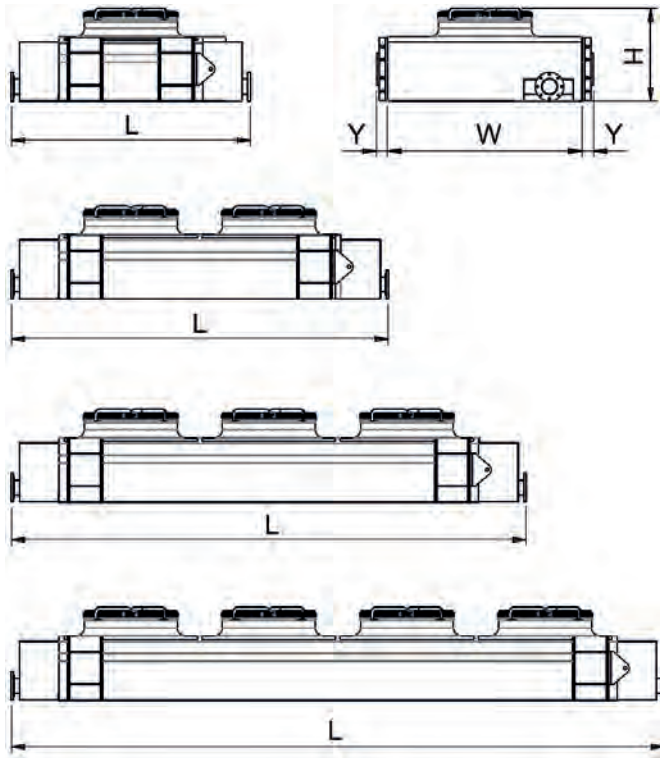

Nr. of fans	Dimension (mm)						H	Y
	L			W				
	module length			module length				
	C	M	L	C	M	L		
1	1680	1880	2080	1450	1690	1930	820	95
2	2680	3080	3480	1450	1690	1930	820	95
3	3680	4280	4880	1450	1690	1930	820	95
4	4680	5480	6280	1450	1690	1930	820	95

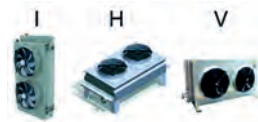

Installation options

## Code description

BO	L	Q	100	2	L	B	Y	36	H	P	7031	SW	-	IF	2.5	CU	Oil
1	2	3	4	5	6	7	8	9	10	11	12	13		14	15	16	17

- AlfaBlue oil cooler (BO=copper tubing, BOA=aluminium tubing)
- Module width (C, M, L)
- Sound level/fan speed (T=high performance, S=standard, M=medium, L=low, Q=quiet, R=dual fan speed)
- Fan diameter (80=800, 90=910, 100=1000 mm)
- Number of fans (1 to 4)
- Coil length (C, M, L)
- Nr. of tube rows (B or C)
- Electrical connection star (Y) or delta (D)
- Nr. of circuits
- Installation (I=on-board, H=airflow vertical, V=airflow horizontal)
- Transport packing (P=pallet, SK=container skid)
- Casing colour (RAL code)
- Options (SW, CB, OF)
- Fin material (IF=industrial fins, SWR=seawater resistant AlMg2.5, EP=epoxy)
- Fin spacing (2.5, 2.8, 3.0, 3.2, 3.5 mm)
- Tube material (CU=copper, A=aluminium)
- Operating mode

## Benefits

- Heavy duty design with high corrosion resistance
- Easily cleanable thanks to removable fan motors and industrial power fins
- Fully assembled: easy to connect to the transformer
- Reduced fan motor power consumption as a result of low static pressure
- Excellent sound characteristics
- Reliable performance
- Easy installation & maintenance
- Energy efficient - low total cost of ownership
- Two-year product guarantee.

ERC00323EN 1209

Alfa Laval reserves the right to change specifications without prior notification.

## How to contact Alfa Laval

Up-to-date AlfaLaval contact details for all countries are always available on our website on [www.alfalaval.com](http://www.alfalaval.com)





# FBLG

## Customized air-cooled radiators

### General information & application

Air cooled radiators FBLG have been designed for heavy industrial cooling applications for cooling of various process liquids, even in the most extreme conditions. Dual coil models are available for simultaneous cooling of LT/HT engine circuits. Applications include:

- diesel and gas engine cooling
- turbine cooling
- oil cooling
- various processes (transformers, air compressors, etc.)

Liquids	all liquids that do not corrode copper
Capacities	customer specification

### Standard configuration

- FBLG\* ranges
  - FBLGS = standard unit width (2.6 m)
  - FBLGC = container unit width (2.3 m)
  - FBLGE = custom coil width
  - FBLGA = special coil configuration
  - FBLGY = stainless steel tubing
- Finned coil
  - Copper or stainless steel tubes (FBLGY)
  - corrugated Al-fins 0.18 mm, no turbulators
  - fin spacing 2.3 to 4 mm
- Direct driven axial fans, suitable for use with frequency converters. *When designing a frequency converter system, the general guidelines for allowed cable lengths, sinus filters, dU/dT filters etc. have to be considered.*
- Fan motors available for various power supplies. The motors are squirrel-cage motors for outdoor use built to IEC standards and provided with condensing water outlets and shaft seals together with H-class insulation. Protection class for motors is IP55, except for the condensing water outlets. The motors are prewired to lockable safety switches.
- Fan diameters 1.2 or 2 meter.
- All casing parts are of hot dip galvanized steel plates and/or Aluzinc.
- Specifically designed for multiple installations with several radiators installed side by side.
- Fitted with header tube protection panels.
- Manual venting and draining valves.
- Partitions between fans for regulation of the cooler capacity by means of separate use of the fans.
- Transportation either in wooden seaworthy packing or standard 40'/45' container. Also suitable for truck transportation.

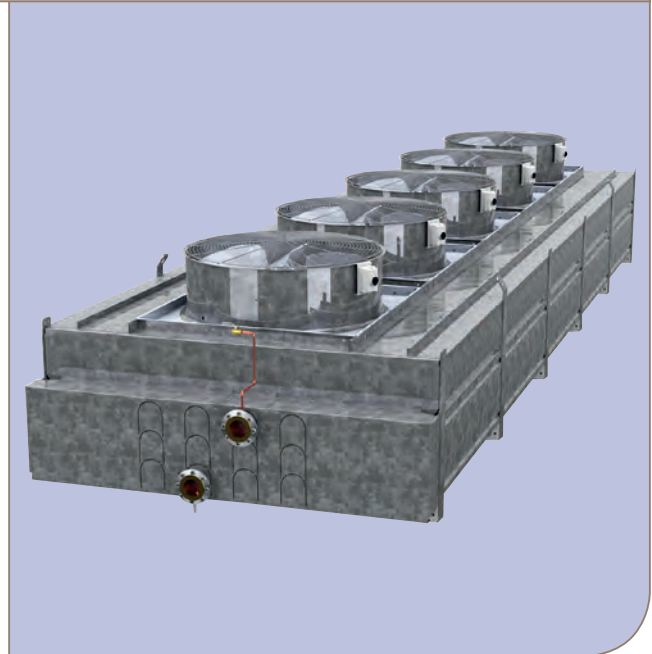

FBLG

### Certifications

The Alfa Laval quality system is in accordance with ISO 9001. All products are manufactured according to CE and PED regulations.

### Design pressure

Design pressure 6 barg. Each heat exchanger is leak tested with dry air at 9 barg. Higher design pressures on request.

### Documentation

For FBLG radiators extensive product & project documentation can be supplied (standard in English).

- Mechanical & electrical configuration
- Quality, test & material certificates
- Project reports & documentation
- Installation, operation & maintenance manuals

## Options

- Coil corrosion protection
  - epoxy coated aluminium fins (Ep)
  - copper fins (Cu)
  - sea water resistant aluminium fins (AlMg)
  - F-coating, FBGLA only (FC)
  - Blygold coating, FBGLA only (Bg)
- Dual coil models with LT- and HT-circuits
- Higher design pressures
- Mounting legs (up to 6m)
- Handrails and ladder for radiator group
- Flexible connection joints
- Epoxy painted casing (RAL colours)
- Fan speed control
  - step control (SC)
  - frequency control (SVC)
- Common terminal box located in the end of radiator
- Motor protective switch panel
- Special fan motors (EX-classed, NEMA etc.)
- Motors equipped with
  - anti-condensation heaters
  - klixon
  - PTC thermistors
  - vibration sensor

## Benefits

- Factory tested plug & play units, easily connectable.
- Short assembly time on site.
- Heavy duty coil & casing materials
- The close tube spacing and the specially corrugated fins make the heat transfer section extremely efficient.
- Plain profile fins without turbulators make the coil less prone to fouling and easier to clean.
- Motors built to IEC standards facilitate spare part service all over the world.
- Robust construction, no service platform required.
- Energy efficient - low total cost of ownership.
- One full year product guarantee.
- Over 20 years experience from more than 1000 projects.

## Selection

FBLG radiators are always selected and customized on customer request. Please contact Alfa Laval for selections.



## Code description

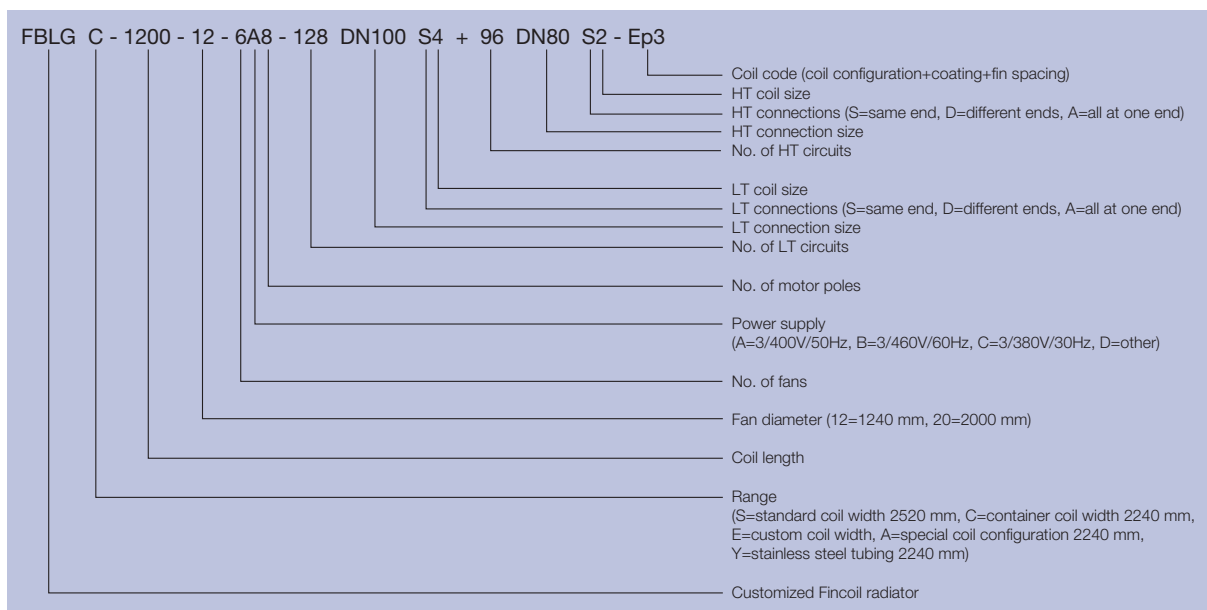

EMD00193EN 1212

Alfa Laval reserves the right to change specifications without prior notification.

### How to contact Alfa Laval

Up-to-date AlfaLaval contact details for all countries are always available on our website on [www.alfalaval.com](http://www.alfalaval.com)







## DCH

### Gen-set radiator units

#### General information & application

Industrial DCH radiator units are designed for cooling of water or other process fluids for Diesel and Gas Power Generation. This heat exchanger configuration offers a compact solution with dimensions and capacity range as typically required for Gen-set containers in the Power Generation industry.

A typical Gen-set container includes the engine, electric generator, radiator, control panel, silencer, etc. DCH radiator units are designed to be installed inside the container. DCH radiator units can also be used for other cooling applications in process and general industries.

#### Heat exchanger coil

The innovative heat exchanger coil gives excellent heat transfer thanks to new corrugated aluminium fins combined with copper tubing. Tubes and fins are available in different diameters and thicknesses.

DCH radiators are designed with two vertically positioned, independent heat exchanger coils. Thanks to the two separated coils or the use of split coil circuits it is possible to cool different fluids. This configuration, dedicated to the Power Generation, allows to cool two different circuits (i.e. LT and HT engine circuit) in a unique, compact radiator unit.

Copper manifolds are provided with aluminium flanged connections, draining and venting nozzles. DCH can have one or two modules, depending on the required performance. Each heat exchanger undergoes a pressure and leak test with dry air at 10 bar (design pressure 9 bar).

#### Fan motors

3-Phase 400V-50Hz squirrel cage induction motors (IEC) are used, on demand 460V-60Hz or other power supply. Protection Class IP55, temperature class F or H, depending to the working conditions. On demand greasers can be included. Each electric fan motor is wired to a terminal box or a safety switch close to the fan cowl.

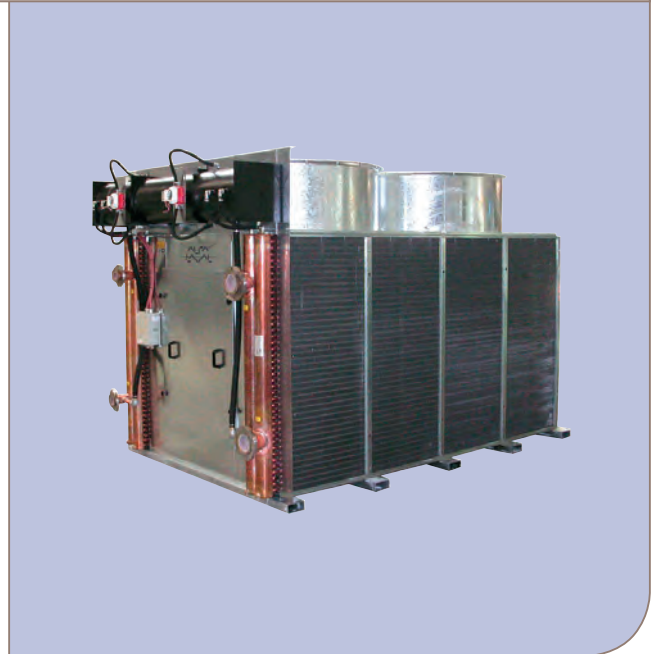

DHC

#### Fan blades

DCH can be supplied with different fan diameters (1250 up to 1440 mm) fitted with fan blades in aluminium (wind profile), fiber glass or galvanized steel. Fans can have either fixed or adjustable blades. Fans are protected by a epoxy coated or hot deep galvanized metal protection grid.

#### Frame and Casing

Casing is made of pre-galvanized sheetsteel. New frame design provides high rigidity, also for heavy applications. Maintenance can be easily done from outside or by entering inside the unit using special inspection doors.

#### Support Feet

Heavy duty, hot-dip galvanized steel profiles permit easy transportation of the unit and can be used at the same time to fix the DCH inside the container.

### Options/Accessories

- Combined version and double circuit (LT / HT)
- Several fin spacings
- Coil treatment for aggressive environments
- Stainless steel tubes
- Counter-flanges
- Vent and drain ball valves
- Extra static pressure drop from 50 to 200 Pa
- Noise absorption
- Expansion tank delivered installed and completely connected to the manifold:
  - Basic or with level indicator
  - Automatic venting (optional)
  - Over-pressure valve (0,5Bar)
  - High temperature piping,
- High Temperature Electric Motors,
- Electric motor Space Heaters,
- Special components for application in hazardous environments (max zone II)
- Electrical parts:
  - Isolating switch (one switch for each fan motor)
  - Terminal box (all fans wired for easy electrical connection switchboard),

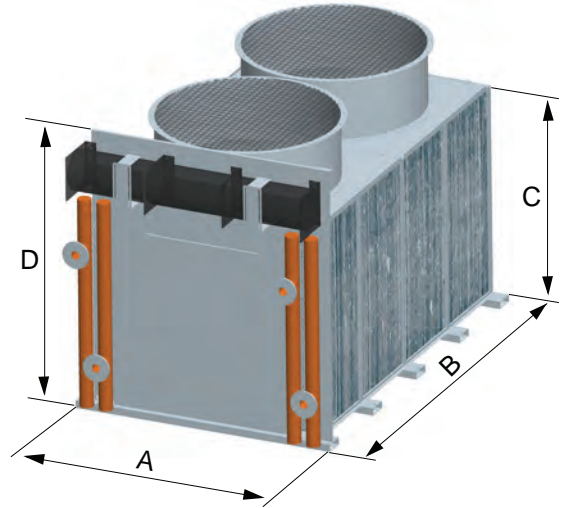

### Main dimensions (mm)

<b>A</b>	Max 2140
<b>B</b>	3100 (without manifolds; in case of two fans)*
<b>C</b>	2050
<b>D</b>	2050

\* Other dimensions on request

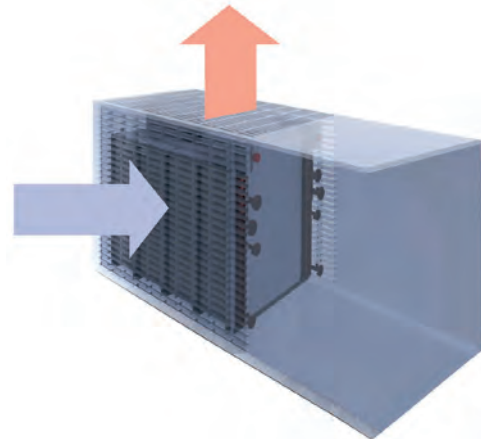

DCH radiator units are designed to be installed inside a 40' HC container.

### Code description

DCH	6	-	2	EE	-	J	8	-	18,5	H	
											DCH gen-set radiator unit
											Tube diameter code (empty=12 mm, 6=16 mm)
											Nr. of fans (1, 2, 3)
											Coil sizes code
											Fan diameter code
											Nr. of motor poles
											Nom. motor power (kW)
											Motor temperature class (H/F)

### Benefits

- Heavy duty construction for a long product life
- Compact solution for installation inside container
- Dry cooling system: no water consumption, no bacteriological problems
- Easy maintenance
- Plug-and-play solution

ERC00385EN 1202

Alfa Laval reserves the right to change specifications without prior notification.

### How to contact Alfa Laval

Up-to-date AlfaLaval contact details for all countries are always available on our website on [www.alfalaval.com](http://www.alfalaval.com)





# Alfa-V Single Row VDM

## Dry coolers – commercial V-range

### General information & application

Alfa Laval supports a sustainable environment. Therefore our new Alfa-V Single Row dry cooler range has been designed according to the following principles: material wastes have been reduced to an absolute minimum, the V-angle with its exceptional guiding optimizes airflow and low coil resistance reduces energy consumption of the fan motors.

Alfa-V Single Row has been specifically designed for commercial refrigeration and air conditioning. Its main purpose is to reject small to medium heat loads in a modest footprint. In the processing industry, dry coolers are suitable for closed circuit cooling of various process liquids.

Capacities\* 20 up to 450 kW  
 \* water, EN1048.

### Coil

An innovative coil design based on 3/8" copper tubes and corrugated aluminium turbo fins provides excellent heat transfer at a minimized refrigerant charge. Standard fin spacing is 2.1 mm.

Separate connections provide the opportunity for independent operation of both dry cooler coils. Flanges stainless steel (UNI EN 1092-1).

### Casing

Casing material is galvanized steel sheet, pre-painted with an epoxy finish (RAL9002). Separated fan sections.

### Fan motors

Fan motors 400/50/3 available in two fan diameters (800 & 910 mm). The motors are with external rotor, protection class IP54 according to DIN 40050. Integrated thermal protection by thermo contacts provides reliable protection against thermal overload. These fan motors are available in five sound level classes: T=high performance, S=standard, L=low, Q=quiet, and R=residential. Motors are wired to one or more common terminal boxes.

### Options

- Multi-circuiting
- Non-standard fin spacing
- Coil corrosion protection
  - Coil coating
  - Fins seawater resistant aluminium alloy 57S/5052
- Spray water device
- Vibration dampers



- Special fan motors
  - 480/3/60 (IP54)
  - EC fan motors
  - Protection class IP55
  - High-temperature motors
  - Explosion proof motors
- Electrical options
  - Isolating switch
  - Motors wired to a common terminal box
  - EMC approval

### Certifications

All dry cooler models are "Eurovent Certify All" certified. The Alfa Laval quality system is in accordance with ISO 9001. All products are manufactured according to CE and PED rules.

### Design pressure

Design pressure 6 bar. Each heat exchanger is leak tested with dry air.

### Selection

For VDM dry cooler selection and support please contact your local Alfa Laval representative.

Model	Fans no.	Transport dimensions			Weight kg	Mounting channels		
		Length L mm	Height H mm	Width W mm		no.	M1 mm	M2 mm
VCM 801	1	1635	1451	1150	230	2	800	-
VCM 802	2	2635	1451	1150	393	2	1800	-
VCM 803	3	3635	1451	1150	557	4	2800	800
VCM 804	4	4635	1451	1150	721	4	3800	1000
VCM 805	5	5635	1451	1150	885	4	4800	1800
VCM 806	6	6635	1451	1150	1049	4	5800	1800
VCM 901	1	1836	1520	1150	260	2	1000	-
VCM 902	2	3036	1520	1150	480	2	2200	-
VCM 903	3	4236	1520	1150	700	4	3400	1200
VCM 904	4	5436	1520	1150	920	4	4600	1300
VCM 905	5	6636	1520	1150	1140	4	5800	2200

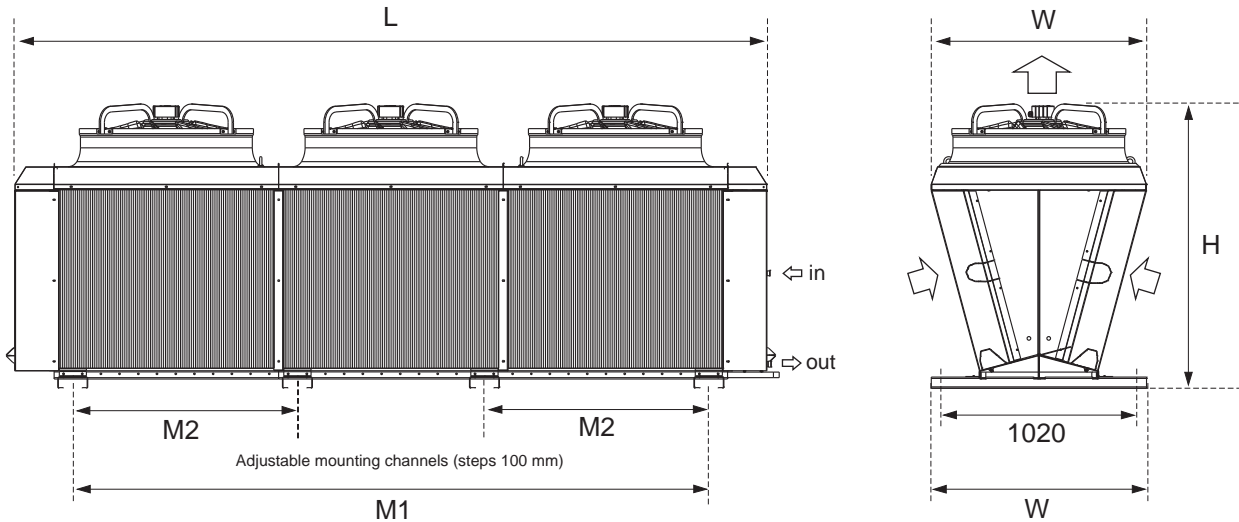

### Code description

VDM	S(E)	80	2	B	D	*	-	AL	2.1	CU	*
1	2	3	4	5	6	7		8	9	10	11

- Alfa-V Single Row dry cooler
- Sound level/fan code (T=high performance, S=standard, L=low, Q=quiet, R=residential, E=EC fan motor)
- Fan diameter (80=800 mm, 90=910 mm)
- Number of fans (1 to 6)
- Number of tube rows (A=2, B=3, C=4)
- Fan motor connection (D=delta, Y=star)
- Electrical options
- Fin material/coating (AL=aluminium, EP=epoxy coated aluminium, FC=F-coat, BY=Blygold)
- Fins spacing (2.1 mm, 2.5 mm)
- Tube material (CU=copper)
- Options

### Benefits

- Excellent sound characteristics, suitable for residential applications.
- Reliable performance, Eurovent certified
- Easy installation & maintenance.
- Energy efficient - low total cost of ownership.
- Adjustable mounting feet
- Modern design
- Heavy duty materials for a long product life
- Two-year product guarantee.

ERC00296EN 1210

Alfa Laval reserves the right to change specifications without prior notification.

### How to contact Alfa Laval

Up-to-date AlfaLaval contact details for all countries are always available on our website on [www.alfalaval.com](http://www.alfalaval.com)





# Alfa-V VDD / VDD6 / VDDY

## Industrial dry coolers V-type

### General information & application

The Alfa-V series is a wide range of heavy duty V-type dry coolers for air conditioning, refrigeration and various industrial applications. Alfa-V dry coolers provide high capacities at a compact footprint.

Alfa-V dry coolers may be used in refrigeration and air conditioning applications such as water/glycol cooling or free cooling. For industrial applications dry coolers are suitable for closed circuit cooling of various process liquids in f.i. food, power, process and general industries.

Capacities\* 54 up to 1600 kW  
 \* water, EN1048.

### Coil

An innovative coil design provides excellent heat transfer. In standard execution dry coolers are fitted with smooth copper tubing (1/2", 3/8" or 5/8") or stainless steel tubing (5/8"). Fins in aluminium or sea water resistant AlMg2.5, available in two fin designs:

Turbo fins	maximized capacity
Industrial power fins	long lasting performance

Available in different fin thicknesses and fin spacings. Separate connections provide the opportunity for independent operation of both dry cooler coils. Flanges stainless steel (UNI EN 1092-1).

### Casing

Frame construction provides high rigidity for protection against vibration and thermal expansion. Casing and framework of corrosion resistant pre-galvanized sheet steel (high corrosion resistance), epoxy coated white RAL 9002 on both sides. Separated fan sections. Supports in galvanized steel.

### Fan motors

Available in three fan diameters (800, 910 & 1000 mm) and five noise levels, power supply 400/50/3. Motors with external rotor, protection class IP 54 according to DIN 40050. Integrated thermo contacts provide reliable protection against thermal overload. EC fan motors available.

### Certifications

Alfa-V dry coolers are "Eurovent Certify All" certified. The Alfa Laval quality system is in accordance with ISO 9001. All products are manufactured according to CE and PED rules.



### Design pressure

Design pressure 6 bar. Each heat exchanger is leak tested with dry air.

### Selection

Selection and pricing is to be performed with our Alfa Laval air heat exchanger selection software. Selection output includes all relevant technical data and dimensional drawings. Please contact our sales organization for details and full technical documentation.

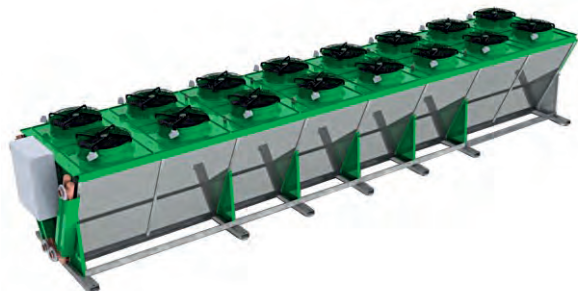

VDD 808



Nbr. of fan pairs	Dimensions mm (indicative)			
	L1*	L2*	H	W
2	2940	3270	2210	2230
3	4250	4580	2210	2230
4	5560	5890	2210	2230
5	6870	7200	2210	2230
6	8190	8510	2210	2230
7	9490	9820	2210	2230
8	10800	11130	2210	2230

\* L1 = VDD/VDD6, L2 = VDDY

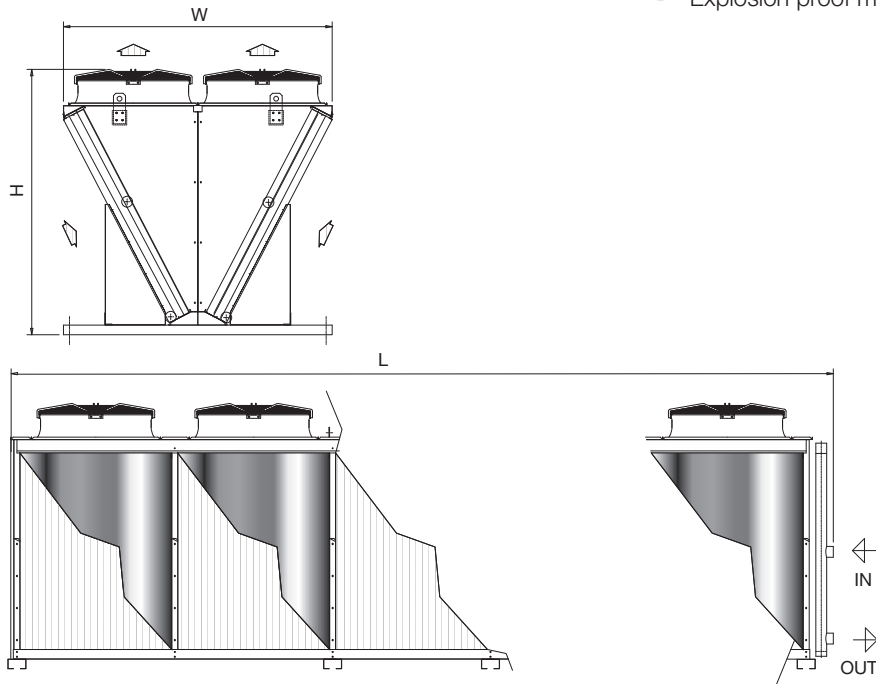

#### Options

- Multi-circuiting
- Non-standard fin spacing
- Coil corrosion protection
  - Coil coating
  - Fins seawater resistant aluminium alloy 57S/5052
- Spray water device
- Vibration dampers
- Special fan motors
  - 480/3/60 (IP54)
  - EC fan motors
  - Protection class IP55
  - High-temperature motors
  - Explosion proof motors
- Electrical options
  - Isolating switch
  - Motors wired to a common terminal box
  - Switchboard (IP55)
  - EMC approval
  - Fan step control
  - Fan speed control
  - Frequency control

#### Code description

VDD	S(E)	90	4	B	D	SK	*	-	AL	2.1	CU	*
1	2	3	4	5	6	7	8		9	10	11	12

- Alfa-V dry cooler (VDD = standard Cu tube), VDD6 = 5/8" Cu, VDDY = 5/8" SS304)
- Sound level/fan code (T=high performance, S-standard, L=low, Q=quiet, R=residential, E=EC fan motor)
- Fan diameter (80=800, 90=910, 100=1000 mm)
- Number of fans pairs (2 to 8)
- No. of tube rows (B=3, C=4)
- Fan motor connection (D=delta, Y=star)
- Packing (SK=container skid)
- Electrical options
- Fin material/coating (AL=aluminium, IF=industrial fins, SWR=AlMg2.5, EP=epoxy coated aluminium, FC=F-coat, BY=Blygold)
- Fins spacing (2.1, 2.3, 2.5, 3.0 and 3.2 mm)
- Tube material (CU=copper, SS=stainless steel)
- Options

#### Benefits

- Heavy duty design with high corrosion resistance
- Reduced liquid charge
- Favourable capacity/footprint ratio.
- Available with easily cleanable industrial power fins
- Excellent sound characteristics, suitable for residential applications
- Reliable performance, Eurovent certified
- Easy installation & maintenance.
- Energy efficient - low total cost of ownership.
- Two-year product guarantee.

ERC00276EN 1210

Alfa Laval reserves the right to change specifications without prior notification.

#### How to contact Alfa Laval

Up-to-date AlfaLaval contact details for all countries are always available on our website on [www.alfalaval.com](http://www.alfalaval.com)





# AlfaSolar SD

## Dry coolers

### General information & application

Dry coolers are often used for cooling down condenser water in air conditioning and refrigeration installations. In the processing industry, dry coolers are suitable for closed circuit cooling of various process liquids. With a wide range of sound pressure level alternatives, these units are particularly suited to demanding, noise sensitive environments. Alfa Solar dry coolers are available for both horizontal and vertical air direction.

Capacities\* 37 up to 1651 kW  
\* water, EN1048.

### Coil

Coil manufactured from copper tubes  $\varnothing$  12.7 mm and corrugated Alu-fins, standard fin spacing is 2.3 mm. Flanges PN10/16 according to DIN 2642.

### Casing

Casing and framework of corrosion resistant, galvanized sheet steel (GS).

### Fan motors

Axial fans in a range of different fan speed executions. Available in two fan diameters: 914 mm (1 to 14 fans) or 1240 mm (1 to 7 fans). Enclosed design fan motors, protection class IP-54, class F insulation. Motors are wired to the fans' safety switches (IP65). All fans have corrosion resistant fan blades and fan guards.

### Certifications

All dry cooler models are "Eurovent Certify All" certified. The Alfa Laval Vantaa quality system is in accordance with ISO 9001. All products are manufactured according to CE and PED rules.

### Design pressure

Design pressure 6 barg. Each heat exchanger is leak tested dry air at 9 barg.

### Transport

Standard vertical transport position, fixed on a wooden pallet.



AlfaSolar SDD

### Options

- Copper (CU) or epoxy coated (EP) fins
- Fin spacings 2.5 and 3.2 mm
- Water spraying system (KW)
- Vibration dampers (VD)
- Step control + options
- Fan speed control with frequency converter (SVC) + options
- EC fan motors, control panels & options
- Casing epoxy painted grey RAL 7040 in four thicknesses (GPU=MU, GP1=M1, GP2=M2, GP3=M3)
- EMC cables, glands & safety switches for each fan (EMC)
- Motors with thermal overload Klixon switches (THC)
- Motor heater (MH)
- Packing: pallet (P) or container (CN)

### Selection

Selection and pricing is to be performed with our Alfa Laval air heat exchanger selection software. Please contact our sales organization for details and full technical documentation.

## Dimensions & weights

unit size	dimensions (mm)					fixing points	weight kg	nt.vol. l	surface m <sup>2</sup>
	L	C	C1	C2	C3				
SDM-1A-3	2000	1400	1400			4	240	32	157
SDM-1A-4	2000	1400	1400			4	260	40	210
SDM-1B-4	2400	1800	1800			4	320	49	269
SDM-2A-3	3400	2800	2800			4	480	61	314
SDM-2A-4	3400	2800	2800			4	520	78	419
SDM-2B-4	4200	3600	3600			4	640	96	539
SDM-3A-3	4800	4200	4200			4	720	85	471
SDM-3A-4	4800	4200	4200			4	780	109	629
SDM-3B-4	6000	5400	5400			4	960	136	808
SDM-4A-3	6200	5600	2800	2800		6	960	113	629
SDM-4A-4	6200	5600	2800	2800		6	1040	145	838
SDM-4B-4	7800	7200	3600	3600		6	1280	180	1078
SDM-5A-3	7600	7000	2800	4200		6	1200	136	786
SDM-5A-4	7600	7000	2800	4200		6	1300	176	1048
SDM-5B-4	9600	9000	3600	5400		6	1600	229	1347
SDD-2B-3	4200	3600	3600			4	920	112	606
SDD-2B-4	4200	3600	3600			4	990	151	808
SDD-2C-4	4800	4200	4200			4	1110	171	943
SDD-3B-3	6000	5400	5400			4	1370	164	909
SDD-3B-4	6000	5400	5400			4	1490	224	1212
SDD-3C-4	6900	6300	6300			4	1670	254	1414
SDD-4B-3	7800	7200	3600	3600		6	1830	222	1212
SDD-4B-4	7800	7200	3600	3600		6	1980	283	1617
SDD-4C-4	9000	8400	4200	4200		6	2200	323	1886
SDD-5B-3	9600	9000	3600	5400		6	2280	267	1515
SDD-5B-4	9600	9000	3600	5400		6	2470	363	2021
SDD-5C-4	11100	10500	4200	6300		6	2770	412	2357
SDD-6B-3	11400	10800	3600	3600	3600	8	2730	331	1819
SDD-6B-4	11400	10800	3600	3600	3600	8	2970	422	2425
SDD-6B-5	13200	10800	3600	3600	3600	8	3200	514	3031
SDD-6B-6	11400	10800	3600	3600	3600	8	3430	605	3637
SDD-6C-4	11400	12600	4200	4200	4200	8	3320	482	2829
SDD-6C-5	13200	12600	4200	4200	4200	8	3590	568	3536
SDD-6C-6	3200	12600	12600	4200	4200	8	3860	675	4243
SDD-7B-3	13200	12600	3600	5400	3600	8	3190	376	2122
SDD-7B-4	13200	12600	3600	5400	3600	8	3460	482	2829
SDD-7B-5	13200	12600	3600	5400	3600	8	3730	568	3536
SDD-7B-6	13200	12600	3600	5400	3600	8	4000	674	4243

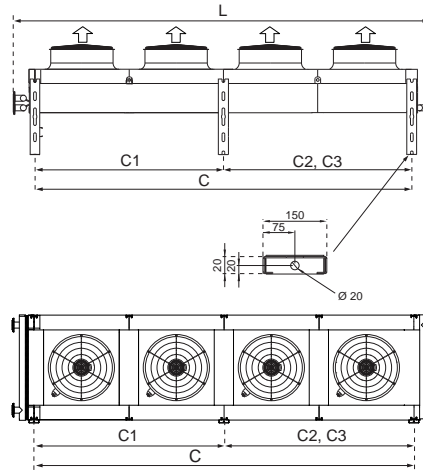

Models SDM

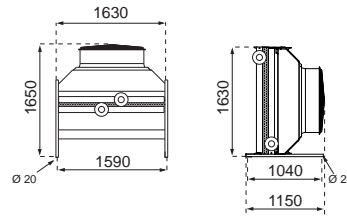

Models SDD

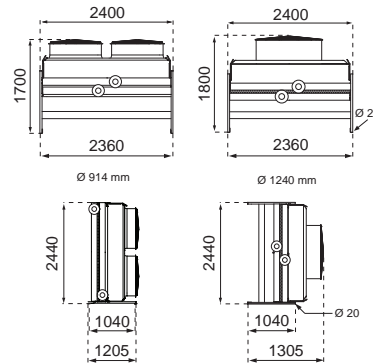

## Code description

SD	D	6	B	09	L	N5Y	4	H	GS	P	*	-	AL	2.1	CU	88	1x	DN80
1	2	3	4	5	6	7	8	9	10	11	12		13	14	15	16	17	

- AlfaSolar dry cooler
- Unit width (M=narrow, D=wide)
- No. of modules
- Module length (A=1400 mm B=1800 mm, C=2100 mm)
- Fan diameter (09=910 mm, 12=1240 mm)
- Fan speed (T=950, S=720, L=560, Q=470, R=350)
- Power supply (N5Y=3/400/50-Y, N5D=3/400/50-D, N6=3/440/60, N7=3/230/50, N8=3/690/50)
- Tube rows in air direction (3,4,5,6)
- Air flow (H=vertical, V=horizontal)
- Casing material (GS, GP\_U/1/2/3)
- Packaging (P=pallet, CN=container)
- Options
- Fin material/coating (AL=aluminium, EP=epoxy coated, CU=copper)
- Fins spacing (mm)
- Tube material (CU=copper)
- No. of circuits
- Connections (1 inlet + outlet DN80 flange)

## Benefits

- Heavy duty coil & casing materials, resulting in a long operational product life.
- Floating coil construction to compensate for thermal stress.
- Plain profile fins make the coil less prone to fouling and easier to clean.
- Excellent sound characteristics
- Reliable performance, Eurovent certified.
- Easy-install & maintenance
- Energy efficient - low total cost of ownership.
- Two year full product guarantee.

ERC00331EN 1210

Alfa Laval reserves the right to change specifications without prior notification.

## How to contact Alfa Laval

Up-to-date AlfaLaval contact details for all countries are always available on our website on [www.alfalaval.com](http://www.alfalaval.com)





# Chapter 10

1. The Alfa Laval Group
2. Heating and cooling solutions from Alfa Laval
3. Applications
4. The theory behind heat transfer
5. Product range
6. Gasketed plate heat exchangers
7. Brazed plate heat exchangers
8. Fusion-bonded plate heat exchangers, AlfaNova
9. Air heat exchangers
- 10. All-welded heat exchangers**
11. Filters





# All-welded heat exchangers

When the duty gets tougher and you still need a compact solution, you should consider an all-welded heat exchanger from Alfa Laval. They come in different shapes and forms to satisfy even the most demanding pressure and temperature requirements.

The *AlfaDisc* provides the exceptional thermal efficiency and compactness of a plate-and-frame unit under conditions that would normally require a bulky, traditional shell-and-tube unit.

The *AlfaRex* has all the benefits of a plate heat exchanger including a compact and flexible design, excellent heat-transfer abilities and very limited need of maintenance.

The *Compabloc* is a breakthrough plate heat exchanger design that combines a whole range of technological advantages in one compact unit. The all-welded plate pack does away with all gaskets between plates, and makes it possible to operate with a wide range of media and at high temperatures and pressures.





## All welded heat exchangers range

AlfaDisc	AlfaRex – TM20	Compabloc
Read all about it on page 10.3	Read all about it on page 10:5	Read all about it on page 10:7
		





# AlfaDisc

## All-welded plate heat exchanger

### Applications

AlfaDisc is suitable for most of the applications, such as general cooling and heating duties, condensation, evaporation, reboiling and stream heating.

### Standard design

AlfaDisc is built on the Plate & Shell concept. It is able to withstand higher design pressure, is more compact, is better developed for fatigue applications, has the possibility for asymmetric flow and is cleanable on one side. These features in combination with an attractive price give us a range of competitive advantages over other welded concepts.

The AlfaDisc all-welded plate heat exchanger provides the thermal efficiency and compactness of a plate and frame unit under conditions that would normally call for a shell and tube unit.

Designed for use with liquids, gases and two-phase mixtures at pressure up to 100 bars (PED & ASME) and at temperatures up to 538°C, the Plate & Shell unit works well with aggressive media, such as organic solvents, steam heaters and interchangers that are beyond the capability of a gasketed unit. The unit is also available with removable core design.

### Typical capacities

#### Liquid flow rate

Up to 157 kg/s (2355 gpm) depending on media, permitted pressure drop and temperature program.

#### Sizes

AlfaDisc 25	AlfaDisc 100
AlfaDisc 50	AlfaDisc 150
AlfaDisc 80	AlfaDisc 200

### Working principle

The unit features a plate side and a shell side, which offer high pressure ratings. It has alternating channels for hot and cold media, and can offer true counter-current or co-current flow. Number of passes could be up to 3 passes maximum on each side.

Nozzle sizes up to DN 700 can be accommodated on the shell side of the exchanger, offering higher steam and liquid flow rates. Nozzles on the plate side can be up to DN 200.

The AlfaDisc unit can be fabricated from dissimilar metals when only one side will be exposed to corrosive conditions.



AlfaDisc 50

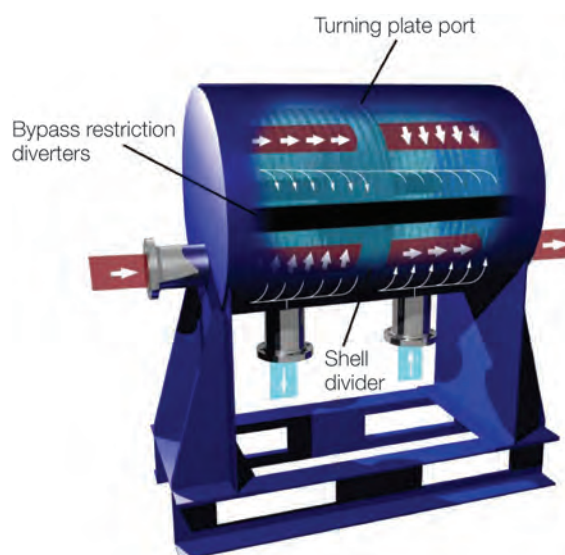

Flow principle of a multi-pass AlfaDisc.



## STANDARD MATERIALS

### Shell material

Mild steel, Epoxy painted or stainless steel

### Cover material

Mild steel, Epoxy painted or stainless steel

### Nozzles

Stainless steel, Titanium and 254 SMO Could be combined with carbon steel flanges

### Plate material

316L, Titanium and 254 SMO

## TECHNICAL DATA

### Design pressure

CE/PED Vacuum to 100 bars  
ASME Vacuum to 100 bars

### Design temperature

Carbon steel Shell -45 - 538°C  
Stainless steel Shell -160 - 538°C

### Maximum heat transfer surface

AlfaDisc 25	4.5 m <sup>2</sup>	(48.5 ft <sup>2</sup> )
AlfaDisc 50	35 m <sup>2</sup>	(377 ft <sup>2</sup> )
AlfaDisc 80	62 m <sup>2</sup>	(667 ft <sup>2</sup> )
AlfaDisc 100	125 m <sup>2</sup>	(1345.5 ft <sup>2</sup> )
AlfaDisc 150	220 m <sup>2</sup>	(2368 ft <sup>2</sup> )
AlfaDisc 200	380 m <sup>2</sup>	(4090 ft <sup>2</sup> )

## STANDARD CONNECTIONS

### Sizes mm (inch)

Model range	Plate side	Shell side
AlfaDisc25	25 (1)	20 - 100 (1 - 4)
AlfaDisc50	50 (2)	20 - 150 (1 - 6)
AlfaDisc80	80 (3)	25 - 250 (1 - 10)
AlfaDisc100	100 (4)	25 - 350 (1 - 14)
AlfaDisc150	150 (6)	25 - 500 (1 - 20)
AlfaDisc200	200 (8)	25 - 700 (1 - 28)

### Pressure ratings

CE/PED PN16, 25&40, PN63 and PN100  
ASME ASME cl. 150, 300 & 600 and Class 900

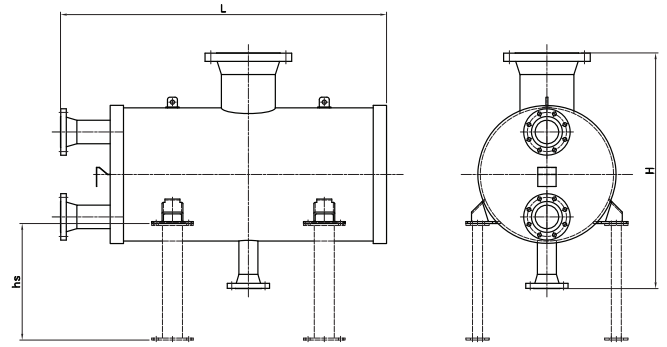

### Dimensions (mm)

Model	H2 min/max		L min/max		hs1 min/max	
AD25	370	850	275	1945	260	740
AD50	630	1050	290	2010	450	790
AD80	790	1270	310	2070	540	1040
AD100	930	1450	340	2125	640	1220
AD150	1130	1700	380	2205	760	1530
AD200	1450	2400	430	2325	1000	1980

### Dimensions (in)

Model	H2 min/max		L min/max		hs1 min/max	
AD25	15	33	11	77	10	29
AD50	25	41	11	79	18	31
AD80	31	50	12	81	21	41
AD100	37	57	13	84	25	48
AD150	44	67	15	87	30	60
AD200	57	94	17	92	39	78

<sup>1</sup> Dimensions vary with support type

<sup>2</sup> Dimensions vary with connection sizes and supports

### Particulars required for quotation

- Flow rates or heat load
- Temperature program
- Physical properties of liquids in question (if not water)
- Desired working pressure
- Maximum permitted pressure drop
- Available steam pressure

### How to contact Alfa Laval

Up-to-date AlfaLaval contact details for all countries are always available on our website on [www.alfalaval.com](http://www.alfalaval.com)



## AlfaRex - TM20

### All-welded plate heat exchanger

Totally gasket free, the TM20 is well suited for applications involving high temperature and/or high pressure with relatively clean media. The media can also be very corrosive (acids, NaOH, etc.).

The TM20 is particularly recommended for the following applications:

- Solvent recovery processes
- Gas dehydration plants
- Batch reactors
- Refrigeration duties

#### AlfaRex design

The TM20 consists of a laser welded pack of corrugated metal plates with portholes for the passage of the two fluids between which heat transfer takes place. The design has been achieved by laser welding the plates together one by one in alternate grooves to form a plate pack. The plate pack is installed in a frame consisting of a frame plate and a pressure plate compressed by tightening bolts. Extended connectors are located in the frame plate with bellow linings welded to the plate pack. The plate corrugations create high turbulence which results in very high thermal efficiency. This in turn leads to compactness and cost efficiency. The corrugations also support the plates against differential pressure and allow utilization of more expensive corrosion resistant materials.

#### Laser welding and fatigue resistance

The welding is performed using laser welding techniques. This means low heat input and a small heat affected zone. The highest quality is assured through a completely automated machine and welding control combined with a helium leakage test.

The construction only utilizes welding in the plane of the plate i.e. in two directions thereby avoiding welds in a third direction. This design ensures retained flexibility of the plate pack allowing for thermal and hydraulic expansions and contractions which will reduce the risk for fatigue cracks.

#### Working principle

The media in the heat transfer are led into the plate pack through portholes at the corners and are distributed into the passages between the plates by the arrangement of sealing welds.

The two media flow in alternate channels in full countercurrent flow, thereby making the exchanger equally suited for liquids as well as gas and two phase duties. Cleaning is done with CIP (Cleaning in Place).



AlfaRex TM20 - All welded plate heat exchanger

## STANDARD MATERIALS

### Frame Plates

Mild steel. High temperature painted

### Extended Nozzles

Metal bellow linings in channel plate material

### Channel Plates

Stainless steel AISI 316, AISI 316L, Titanium gr. 1, Nickel 200/201

### TECHNICAL DATA (Maximum design performance\*)

FB	up to 10 barg
FC	up to 16 barg
FF	up to 25 barg
FK	up to 40 barg
FN	up to 40 barg

Design temperature range	-50° to + 350°C
Maximum flow rate	700 m <sup>3</sup> /h
Maximum heat transfer surface	250 m <sup>2</sup>

\* Depending on design temperature and pressure vessel code

### CONNECTIONS

FB – DN200/8"	DIN PN10 or ANSI 150
FC – DN200/8"	DIN PN10, PN16 or ANSI 150, ANSI 300
FF – DN200/8"	DIN PN16, PN25 or ANSI 150, ANSI 300
FK – DN200/8"	DIN PN25, PN40 or ANSI 300, ANSI 400
FN – DN200/8"	DIN PN40 or ANSI 300, ANSI 400

## Dimensions

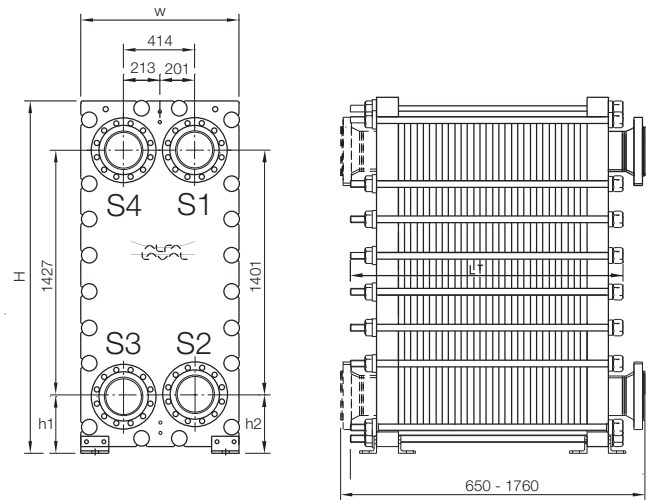

Type	H	W	h1	h2
TM20-BFB, -BFC	1990	865	301	314
TM20-BFF, -BFK, -BFN	2040	915	327	340

Measures are in millimeters

### Particulars required for quotation

To enable Alfa Laval's representative to make a specific quotation, please make sure your enquiry includes the following particulars:

- Flow rates required
- Temperature program
- Physical properties of media in question
- Desired working pressure
- Maximum permitted pressure drop
- Design pressure and temperature
- Pressure vessel code
- Data on cyclic variations in temperature and pressure

### How to contact Alfa Laval

Up-to-date AlfaLaval contact details for all countries are always available on our website on [www.alfalaval.com](http://www.alfalaval.com)



## COMPABLOC Compact heat exchanger range

High-performance fully welded heat exchanger for process industries

### Application

The Alfa Laval Compabloc is a fully welded compact heat exchanger designed for the complete range of process and utility duties. The Compabloc range provides the most efficient, cost-effective, compact and cleanable heat exchanger solution available today. After 20 years on the market, the Compabloc has shown itself to be the market leader in terms of life-cycle costs and energy savings.

### Design

Alfa Laval designed the Compabloc range of welded heat exchangers with a focus on performance, compactness, and serviceability.

The heart of the Compabloc is a stack of corrugated heat transfer plates in 316L stainless steel, or other high-grade material. The plates are laser welded (models CP30 and above) and form a compact core. This core is then enclosed and supported by four corner girders, top and bottom heads and four side panels (see Sectional view of Compabloc). These components are bolted together and can be quickly taken apart for inspection, service and cleaning.

The design can be configured in single or multi-pass arrangements in either co-current or counter-current operation, for liquid-to-liquid or two-phase duties.

### Operating Principles

The two media in the Compabloc heat exchanger flow in alternately welded channels between the corrugated plates. These corrugated plates promote high turbulence which provides high heat transfer efficiency and help minimize fouling. The media flows in a cross-flow arrangement within each pass (see figure below) while the overall flow arrangement is counter-current for a multi-pass unit (if required the unit can also be designed with overall co-current operation). Each pass is separated from the adjacent passes by a pressed baffle which forces the fluid to turn between the plate pack and the panel.

Compabloc's flexible pass arrangements make it suitable for liquid-to-liquid duties with dissimilar flow rates, or two phase condensation or reboiler applications.



### Options

The Compabloc is available in virtually any material that can be pressed and welded, including:

- 316L SST
- 254 SMO
- Titanium
- Alloy C-276
- 904L SST (UB6)
- Alloy B-2
- Alloy C-22
- Incoloy 825
- Inconel 600
- Tantalum

The panels and nozzles can be un-lined or lined using the same materials as the plate pack. The nozzle size is variable and can be selected independently for each side.

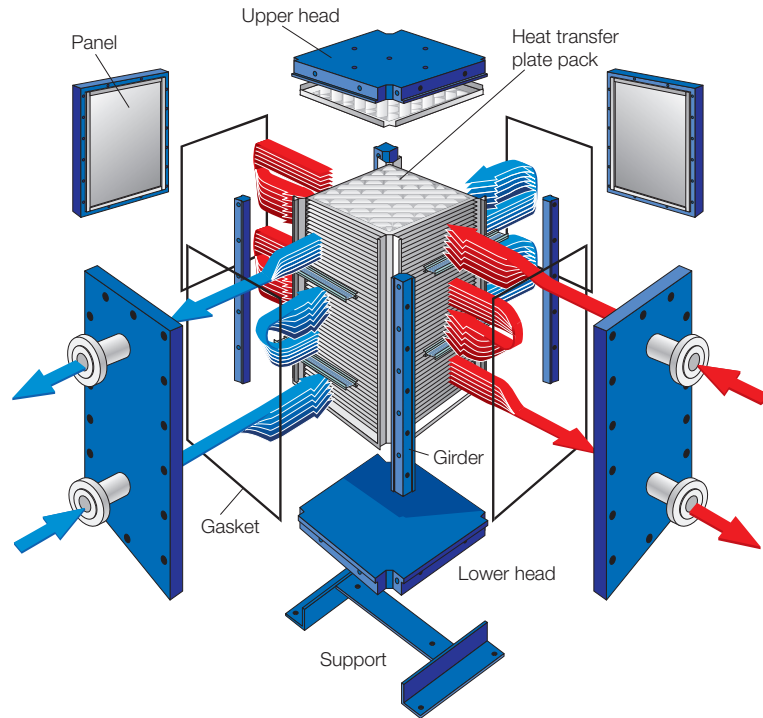

Sectional view of Compabloc

### Process Optimization

Because of the Compabloc's unique design concept the possibilities for process optimization and flexibility are limitless. The Compabloc can be designed with both single-pass or multi-pass configurations. For condensation, reboiling and liquid-to-liquid duties without temperature cross, the singlepass configuration is suitable with its total cross-flow. The large cross flow area and short flow path fit low-pressure condens-ing duties and allow very low pressure drops. A multi-pass configuration is suitable for duties with temperature cross and close temperature approaches.

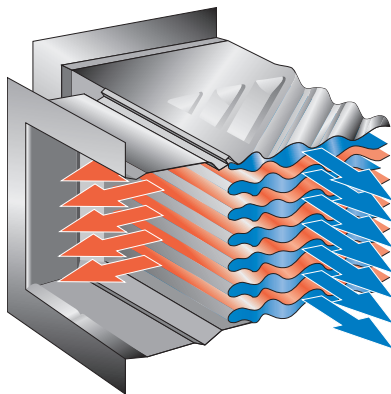

The two media flow in cross-flow in alternately welded channels.

The design concept allows a different number of passes on the two circuits thereby enabling large differences in flow rates between the hot side and the cold side. The baffling can easily be re-arranged to suit a new duty should the flow rates or temperatures change. Close temperature approaches down to 3°C (5.4°F) can be achieved.

The Compabloc can be mounted vertically, for normal liquid-to-liquid duties, condensation with sub-cooling and gas cooling duties, or horizontally, for most condensation duties, reboiling or liquid-to-liquid duties where height is restricted.

There are currently seven plate family models with heat transfer areas ranging from 0.7 to 840 m<sup>2</sup> per unit and each model is modularized with different numbers of plates to allow the best fits for any duty.

### Special applications

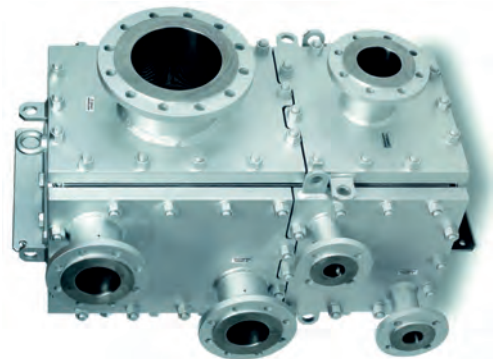

Special applications

For special applications, the Compabloc 2 cooling medium range is available which offers a two-section condenser with two different cooling medias.



### Pressure vessel codes

The Compabloc is available as standard in accordance with international pressure vessel codes such as ASME (with or without U stamp) or ADM (code for PED and CE marking).

### Dimensions

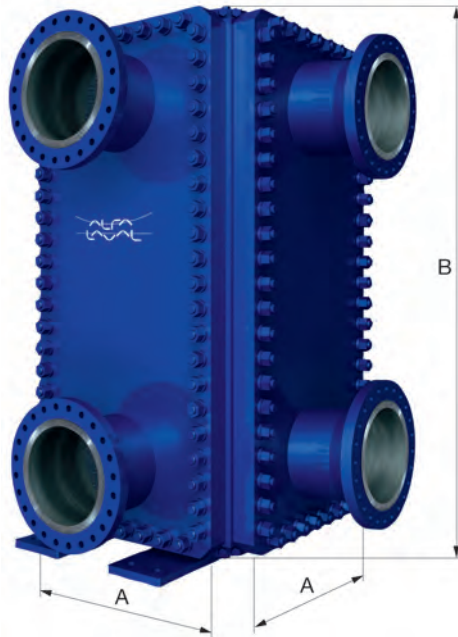

### Technical Data

Model	Standard Pressure Range (bar) *	Standard Temp. Range (°C)	*Code	Max. Dimensions (mm) *** A x A x B	Max. Weight (kg) ****
CP 15	FV - 32	-40 - 300	PED	280 x 280 x 540	250
CP 20	FV - 32	-40 - 300	PED	430 x 430 x 730	550
CP 30	FV - 32	-40 - 300	PED	500 x 500 x 1070	1160
CP 40	FV - 32	-40 - 300	PED	600 x 600 x 1400	2330
CP 50	FV - 32	-40 - 300	PED	840 x 840 x 2050	5940
CP 75	FV - 32	-40 - 300	PED	1240 x 1240 x 3600	17780
CP 120	FV - 42	-50 - 400	PED	2190 x 2190 x 3500	50000

\* other pressures and temperatures may be available on request.

\*\* ASME is also available

\*\*\* does not include nozzle length.

\*\*\*\* weight is determined by maximum number of plates and highest pressure rating.

Note: both vertical and horizontal configurations are available.

**How to contact Alfa Laval**

Up-to-date AlfaLaval contact details for all countries are always available on our website on [www.alfalaval.com](http://www.alfalaval.com)



# Chapter 11

1. The Alfa Laval Group
2. Heating and cooling solutions from Alfa Laval
3. Applications
4. The theory behind heat transfer
5. Product range
6. Gasketed plate heat exchangers
7. Brazed plate heat exchangers
8. Fusion-bonded plate heat exchangers, AlfaNova
9. Air heat exchangers
10. All-welded heat exchangers
- 11. Filters**





# Filters

With diminishing supplies of water of sufficiently high quality to allow the plate heat exchangers in systems to operate efficiently, the need for cost-effective solutions to eliminate clogging by debris, marine life, fouling and impurities has become increasingly apparent.

The *ALF* filter is an automatic self-cleaning filter sized on the basis of the type of fouling encountered and the type of plate heat exchanger installed downstream.

The *Alfa Laval Port* filter is used to protect heat exchangers from intermittent fouling or to prevent foreign objects from entering the heat exchanger during a system startup.

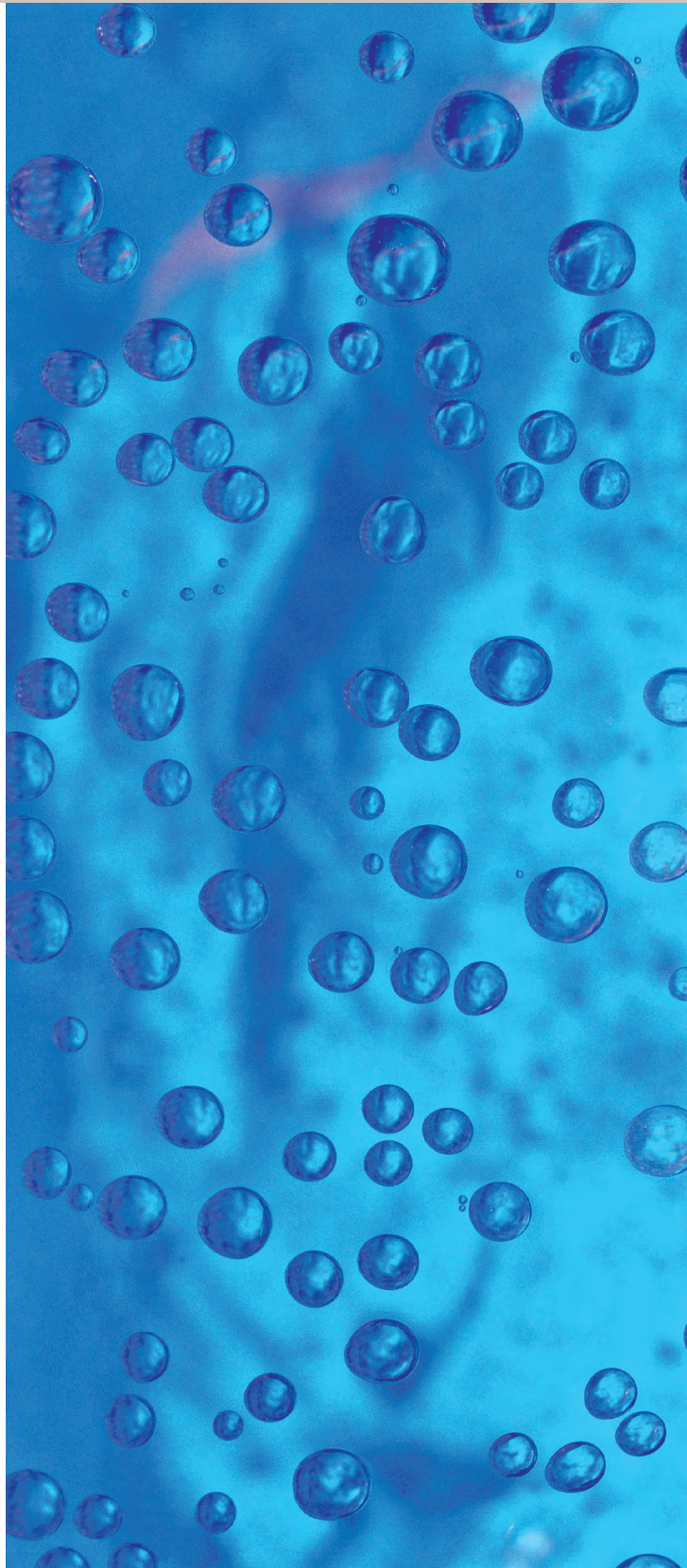

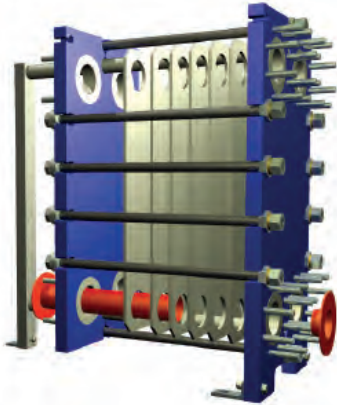

## Filter range

ALF – Alfa Laval Filter	Alfa Port Filter
Read all about it on page 14:3	Read all about it on page 14:7
 A large, blue, cylindrical Alfa Laval ALF filter. It has a horizontal orientation with two large circular ports on the front and back. A yellow handwheel is mounted on top for manual operation. The Alfa Laval logo is visible on the side.	 A vertical Alfa Port filter. It features a blue frame with multiple horizontal rows of filter elements. The filter elements are cylindrical and arranged in a grid. There are several ports and valves on the right side, including a prominent red-handled valve at the bottom.





## ALF – Alfa Laval filter

Filtration for cooling systems using low-quality water



The use of inexpensive secondary cooling water from locations such as the sea, lakes or rivers has become a successful cooling solution that is now widely accepted in industry. Secondary cooling is in widespread use on ships, in power plants and in district heating and cooling systems.

However, such installations require large quantities of clean cooling water. With the supply of high-quality cooling water diminishing, the need for cost-effective solutions to eliminate clogging, fouling and corrosion has become increasingly more apparent. In a cooling system incorporating a heat exchanger and an Alfa Laval Filter, even polluted or corrosive water can be used to cool the most sensitive process equipment.

The Alfa Laval Filter (ALF) operates as an integral part of a cooling system, to remove debris that can foul and clog plate heat exchangers, tubular condensers, cooling tower spray nozzles or any similar equipment. In spite of effective screening at the water intake, mussels, seaweed and other forms of marine life can settle on the heat transfer surfaces.

Conditions are ideal for the growth of these forms of life and, as a result, they multiply rapidly. This then causes less effective heat transfer and even the complete breakdown of heat exchangers or other equipment.

If these kinds of blockages are severe, measures such as pesticides or chlorination are often no longer sufficient. In some cases, these simply cannot be used because they are prohibited by environmental legislation.

This is where Alfa Laval Filter technology comes in. It protects a wide range of sensitive equipment from clogging and fouling, and also prevents blockages in the cooling water system. An Alfa Laval Filter removes debris and marine life, and is automatically backflushed at regular intervals to keep it clean.

Standard control panel with PLC for one filter. Alternative configurations are available for controlling multiple filters. Options for remote control or high protection classes, such as ATEX, are also available.





## Operation and design

The Alfa Laval Filter is a pressure filter with an automatic flushing arrangement. The design features a pressure vessel casing made of stainless steel (ALF-S), fibreglass reinforced polyester (ALF-P) or rubber-lined carbon steel (ALF-R). The internal cylindrical filter basket, along with other wetted parts, is usually made of stainless steel, super stainless steel (SMO) or titanium.

The filter system is available with connections ranging from 100 mm/4" to 800 mm/32" and is designed for placing directly in the pipe system. Because the automatic regeneration process is run by the inlet pressure, and the nozzles can be mounted in almost any way required, the Alfa Laval Filter can be mounted in almost any position.

The inlet is placed at one end and the main outlet at a 90° angle, making it suitable for installation on any 90° pipe bend close to the equipment to be protected. The inspection/service opening is placed on the opposite side of the inlet, thus providing easy service access with no need to remove the pipe connection.

Automatic flushing is carried out at regular intervals without interrupting the filtering process. The flushing arrangement is completely automatic and contains a flushing valve and a flow diverter valve. These are regulated using actuators controlled by a PLC in the control panel, which can be installed close to the filter.

The filter itself is divided into two sections by the flow diverter valve, the inlet section and the outlet section. A flushing valve for discharging the debris is located at the end of the outlet section.

## Normal operation

During normal operation, liquid passes through the inlet into the filter basket, in which the flow diverter valve is open and the flushing valve closed. The liquid passes through the filter basket prior to being discharged at the main outlet.

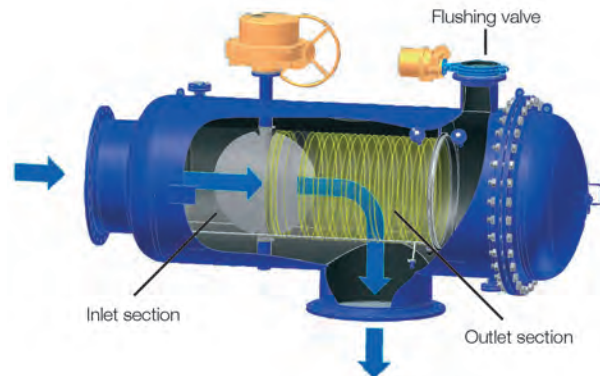

NORMAL OPERATION

## Regeneration

ALF units can be cleaned either automatically, using a timer, at predetermined intervals, or manually by pushing a button on the control panel. An optional differential pressure control system is available as a back-up and for monitoring the filter status.

### 1. Primary flushing

The flushing valve opens, thereby reducing the pressure drop and increasing velocity and total flow through the filter. Any debris sticking to the filter basket is dislodged and flushed out through the flushing valve. The liquid velocity is sufficient to remove any debris embedded in the inlet section of the basket.

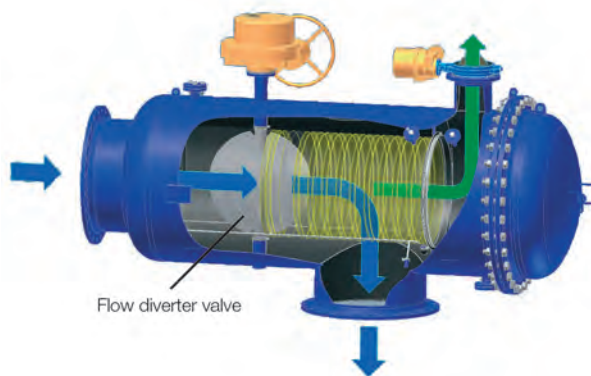

REGENERATION – primary flushing

### 2. Secondary flushing (backflushing)

The flow diverter valve closes, while the flushing valve remains open. The flow is diverted and forced to pass through the filter basket in the inlet section. The majority of the liquid is discharged through the main outlet, but the pressure in the filter draws part of the flow from the exterior to the interior of the outlet section. This provides a backflushing effect in this section of the filter. Any dislodged remnants are discharged through the flushing valve.

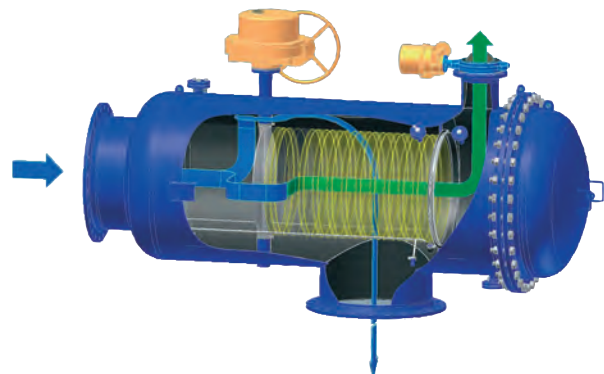

REGENERATION – secondary flushing (backflushing)



## Installation

ALF units can be installed upstream of heat exchangers with shut-off valves placed upstream of the filter and downstream of the heat exchanger. This enables flexible servicing if many units are installed in parallel— for instance in a duty/standby installation or when installed on a bypass pipe, allowing the filter to be taken out of service separately.

Depending on pipe dimensions, flow rate and the permissible pressure drop, one ALF filter can be installed to protect several heat exchangers. The filter(s) should preferably be mounted

close to the heat exchanger(s) in order to minimize the risk of biological growth in the pipe system connecting the components.

Due to the flexible nozzle orientation, ALF filters can be installed in almost any position, horizontally as well as vertically. Alfa Laval recommends connecting the flushing outlet to the heat exchanger outlet when possible, and returning the debris to the natural water source. It is important that the filter is installed downstream of the feed pump(s), operating as a pressure filter.

## Dimensions



ALF-R with filter casing made of rubber lined carbon steel.

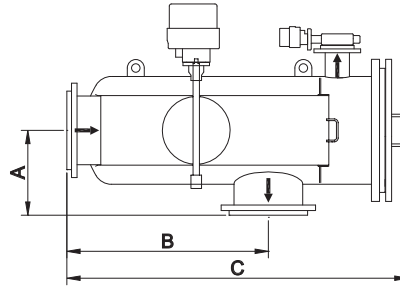

### ALF-R

	A	B	C
ALF 20R	325	720	1230
ALF 30R	425	950	1610
ALF 40R	496	1150	1165
ALF 50R	600	1400	2380
ALF 60R	700	1650	2605
ALF 80R	905	2080	3720



ALF-S with filter casing made of stainless steel.

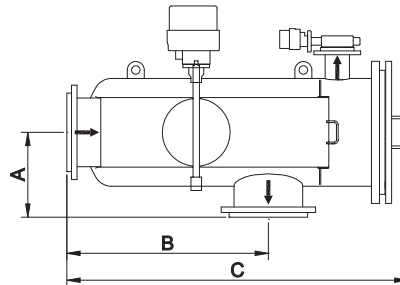

### ALF-S

	A	B	C
ALF 10S	175	450	740
ALF 15S	250	595	975
ALF 20S	300	720	1180
ALF 30S	400	950	1610



ALF-P with filter casing made of fibreglass reinforced polyester.

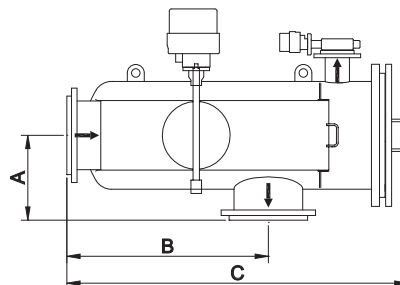

### ALF-P

	A	B	C
ALF 10P	250	530	890
ALF 15P	300	685	1150
ALF 20P	350	840	1400
ALF 30P	520	1130	1820
ALF 40P	570	1150	2110

## Pressure drop for Alfa Laval filters

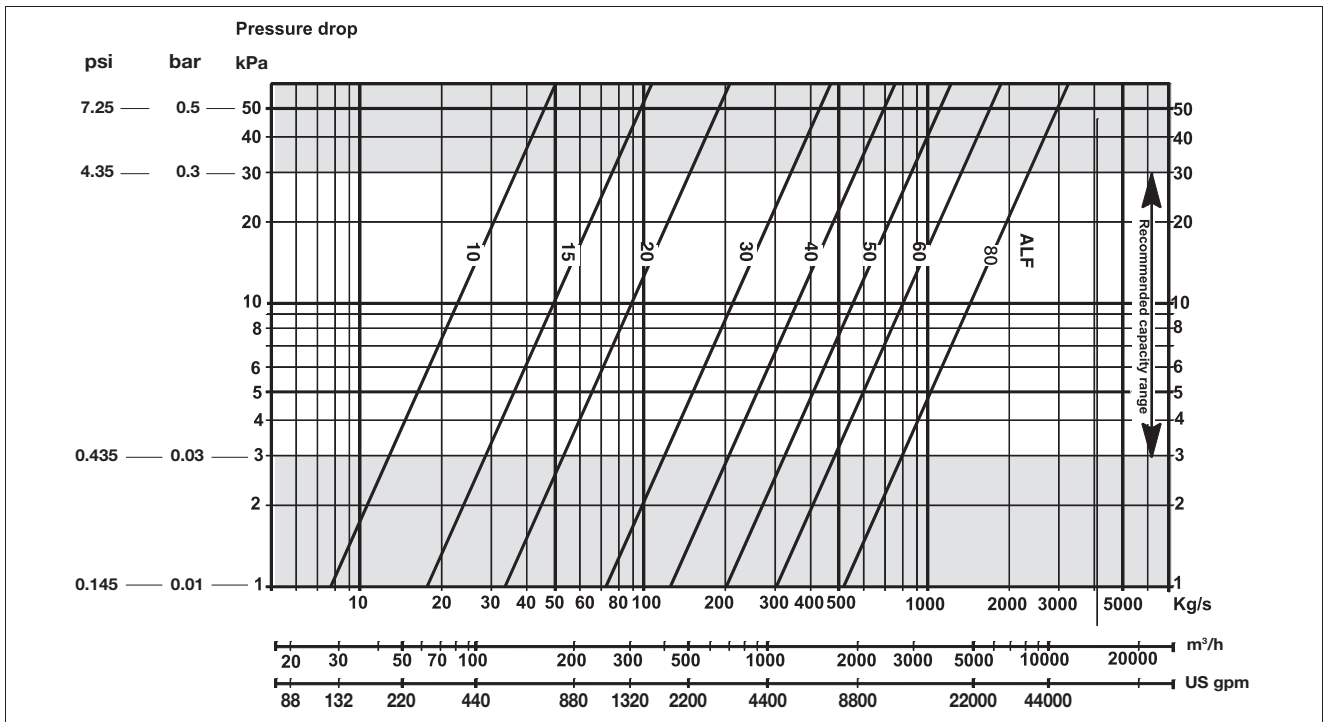

Fig. 3 Recommended pressure drop and capacity range

Technical data		
Connections	EN 1092.1/PN10	DN100-DN800
	ANSI B16.5/B16.47, B series, # 150	4"-32"
	JIS B2238/K10	DN100-DN800
Operation	Pneumatic, electric or hydraulic	Actuator controlled valves
Mesh size	Perforated plate design (Ø hole)	1.0-1.5-2.0-2.5 mm
	Wedge wire design (slot size)	0.3-0.5-1.0 mm
Materials	Filter body (ALF-R)	Rubber-lined carbon steel (EN P265 GH/ASTM A516 Gr60)
	Filter body (ALF-S)	Stainless steel EN 1.4404 ASTM 316
	Filter body (ALF-P)	Fibreglass reinforced polyester (GRP/FRP)
	Internal parts (wetted)	Stainless steel EN 1.4404 ASTM 316
	Internal parts (wetted)	Super stainless steel, EN 1.4547 / ASTM S31254 (SMO)
	Internal parts (wetted)	Titanium, EN 3.7025 / ASTM B265 Grade 3
Design code	EN13445 / ASME VIII, div.1/div.2	ALF-R / ALF-S
Design code	EN13121 / ASME X	ALF-P
Design pressure	10 bar (g) / 150 psi	Alternatives on request
Design temperature	65°C / 149°F	Alternatives on request
Control panel	PLC-based	Power supply: 1~ 100-250 V, 50-60 Hz

PEE00007EN 0811

Alfa Laval reserves the right to change specifications without prior notification.

### How to contact Alfa Laval

Up-to-date AlfaLaval contact details for all countries are always available on our website on [www.alfalaval.com](http://www.alfalaval.com)



# Plate heat exchanger

## Port filter

### Application

The Alfa Laval port filter is used to ensure thermal efficiency of the heat exchanger by preventing foreign objects from entering and causing clogging of the unit. The filter is designed to operate in conditions involving sea water, process water, cooling tower water or any kind of water containing particles with potential risk of disrupting the performance of the system.

### Design

The filter consists of a cylindrical meshed body extending the total length of the plate pack. A cone shaped guiding ring is inserted at the inlet of the port and keeps the filter fixed during operation as well as preventing debris from entering between filter body and plate pack. A welded ring in both ends provide a flat surface for gasket sealing against piping and inspection cover.

### Installation and maintenance

The filter is inserted and accessed from an extra port placed at the opposite side where the media piping is connected. An inspection cover is mounted to seal the port and makes it easy to access the filter when maintenance is needed. Removal of the port filter for inspection or maintenance is possible without dismantling the inlet pipework.

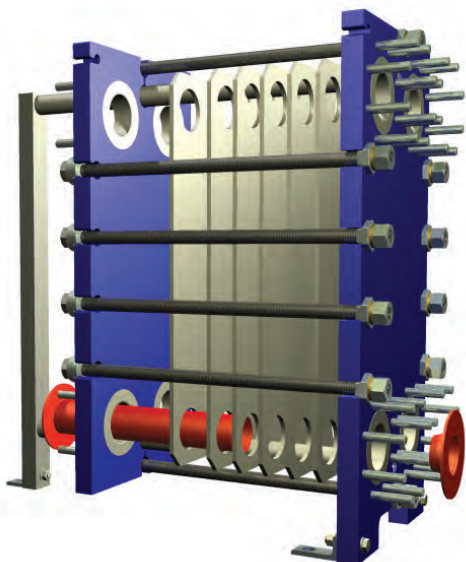
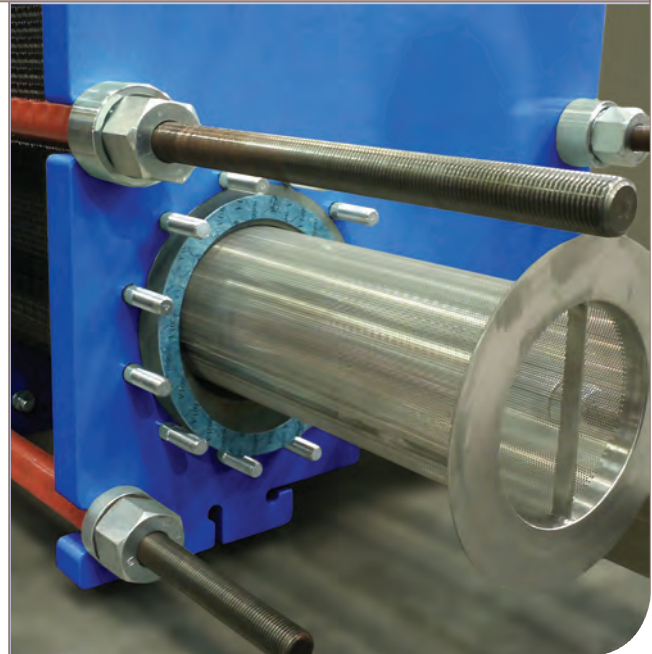

### Benefits

- Prevents clogging
- Extended operation time
- Easy installation
- Easy to service
- Minimized down-town

### Technical data

Available for most standard heat exchanger types with connection size Ø100 mm (4 in) and larger.

Material:	Alloy 316L, Alloy 254 (standard for sea water applications) and titanium. Other materials available on request.
Mesh size:	Ø1.5-2.2 mm (0.06-0.09 in) with a corresponding pitch providing an open surface of 37%.
Body thickness:	1 mm (0.04 in)
Ring thickness:	3-5 mm (0.12-0.20 in)

**How to contact Alfa Laval**

Up-to-date AlfaLaval contact details for all countries are always available on our website on [www.alfalaval.com](http://www.alfalaval.com)

**Alfa Laval in brief**

Alfa Laval is a leading global provider of specialized products and engineered solutions.

Our equipment, systems and services are dedicated to helping customers to optimise the performance of their processes. Time and time again.

We help our customers to heat, cool, separate and transport products such as oil, water, chemicals, beverages, foodstuffs, starch and pharmaceuticals.

Our worldwide organization works closely with customers in almost 100 countries to help them stay ahead.

**Alfa Laval  
Industrial Equipment Segment  
Market Unit Fluids & Utility**



[www.alfalaval.com/fluidpower](http://www.alfalaval.com/fluidpower)



[www.alfalaval.com/metalworking](http://www.alfalaval.com/metalworking)

Local Alfa Laval agent

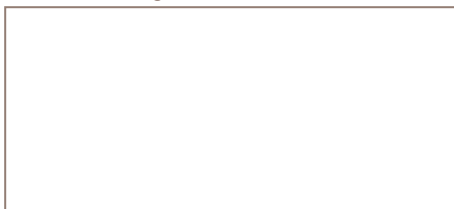

EFU00155EN 1312

Alfa Laval is a registered trademark of Alfa Laval Corporate AB.  
Alfa Laval reserves the right to change specifications without prior notification.

